

802.11g mini-PCI Radio Module

MODEL WL-463

The 3Com 802.11g mini-PCI Radio Module kit contains everything you need to install an additional radio and antenna into your 3Com Access Point.

Kit Contents

The upgrade kit contains these items:

- one antenna module
- one 802.11g mini-PCI Radio Module
- two cables
- two antennas

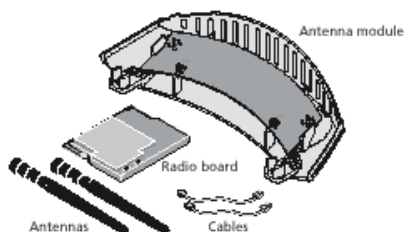

1 Detach and disconnect the access point.

If the access point is mounted on the wall, turn the unit counterclockwise to disengage it from the mounting plate. Disconnect the Ethernet cable. Place the access point face down on a static-free surface.

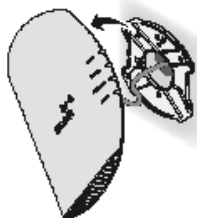

2 Remove the back cover.

Using a cross-tip screwdriver, remove the four screws from the back cover. Remove the cover from the unit. Set the cover and screws aside.

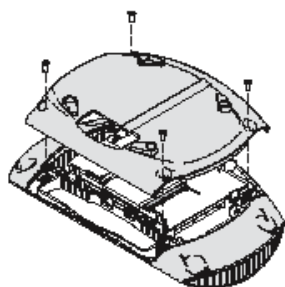

3 Remove the antenna housing.

Grasp the inside edge of the antenna housing and pull up to disengage the housing from the unit, as shown below. This part is no longer needed.

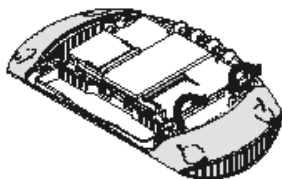

4 Install the radio board.

Holding the radio board at an angle, align the contact edge with the mini PCI connector on the unit. Make sure the keying notch on the contact edge lines up with the key on the connector, as shown in the detail below. Slide the board into the connector and press down gently until the two retainer clips snap into place.

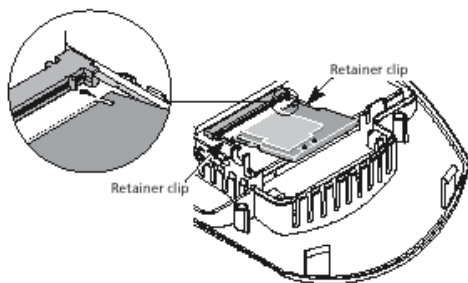

5 Attach the cables to the antenna module.

With the notched side of the square connector facing up (button side facing down), insert one cable connector into the B1 connection on the antenna module and push gently until it snaps into place. Attach the other cable connector to the B2 connection in the same manner.

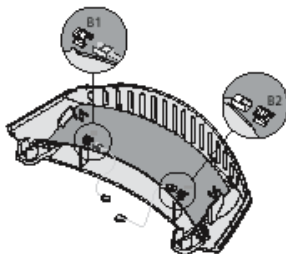

6 Attach the antenna module and connect the cables.

- 1 Align the antenna module with the snaps and posts on the unit and press until the module snaps firmly into place. Make sure the cables are routed through the slots in the unit.
- 2 Align the free end of one cable with one connector on the board. Press until the cable snaps into place. Repeat with the other cable and the other connector. (You can connect either cable to either connector; the order is not important.)
- 3 After the cables are connected, press them down out of the way inside the housing.

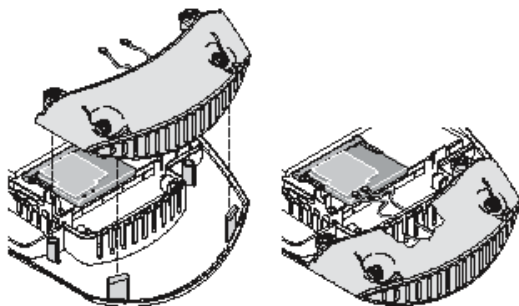

7 Replace the back cover.

Make sure that the cables are tucked away inside the housing so that they do not obstruct the cover. Align the back cover with the unit and settle the cover into place. Tighten the four screws.

8 Attach the antennas.

Being careful not to touch the antenna tips, screw the antennas onto the SMA connectors and hand tighten them. After network startup, you may need to adjust the antennas to fine tune radio coverage.

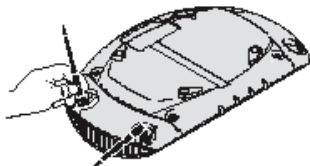

9 Reinstall the access point.

Reconnect the Ethernet cable and reattach the access point to the wall mounting plate. Adjust the antennas to improve the radio signal, if necessary.

SELECTING AND CONNECTING A DIFFERENT ANTENNA MODEL

The standard detachable antennas supplied with the WL-463 11g mini-PCI radio module and are suitable for a broad variety of environments. If you require a different type of antenna several options are available by model number from the 3Com Web site (www.3Com.com).

For each of the antenna models, you will need either a 6-foot accessory cable (model 3CWE480), a 20-foot accessory cable (model 3CWE481) or a 50-foot accessory cable (model 3CWE482) to provide the transition from the SMA connector on the access point to the N-type connector on the antenna. To ensure the physical safety of anyone near the antenna and to prevent damage to the access point, follow the building codes for antenna installations in your area. Also, when connecting the optional antenna to the access point, remember to use only the A-side connector on the access point, on the right when properly installed.

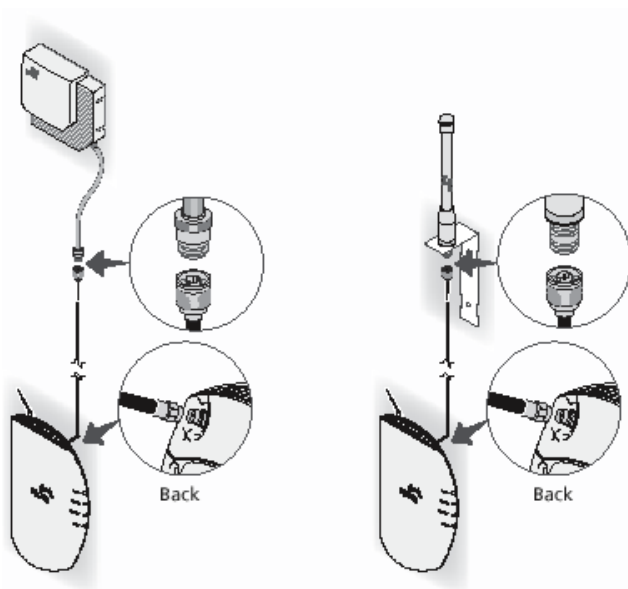

1 Position the antenna so that there are minimal obstacles between it and any client with which it will communicate. While maintaining a direct line of sight between the antenna and a client is not strictly necessary, such an arrangement helps to ensure a strong signal. Ensure that access is available for routing the antenna cable from the antenna to the access point.

2 If they are installed, remove both arms of the standard detachable antenna, making sure not to handle the tips of the antenna.

3 Connect one end of the optional antenna cable to the antenna and secure the antenna in place.

4 Connect the free end of the antenna cable to the right-hand side connection on the access point, as shown in the illustration above.

5 Make certain that the antennas and antenna masts are appropriately grounded to prevent injury or damage from lightning strikes.

POWER SETTINGS ON THE ACCESS POINT FOR EXTERNAL ANTENNAS

USA/CANADA

	2.5dBi (3CWE492)	4dBi (3CWE490, 3CWE497)	8dBi (3CWE491, 3CWE498)
6 ft (3CWE480)	Max	Max	Max
20ft (3CWE481)	Max	Max	Max
50 ft (3CWE482)	Max	Max	Max

Regulatory Compliance Information

3Com 802.11g Wireless LAN Access Point Upgrade Kit

FCC Radio-Frequency Exposure Notice

This device generates and radiates radio-frequency energy. In order to comply with FCC radio-frequency radiation exposure guidelines for an uncontrolled environment, this equipment has to be installed and operated while maintaining a minimum body to antenna distance of 20 centimeters.

This product does not contain any user serviceable components. **Any unauthorized product changes or modifications will invalidate 3Com's warranty and all applicable regulatory certifications and approvals. This product must be installed by a professional technician/installer.**

FCC Part 15 Notice (Applicable to Use Within the USA)

This device complies with part 15 of the FCC Rules. Operation is subject to the following two conditions: (1) This device may not cause harmful interference, and (2) this device must accept any interference received, including interference that may cause undesired operation.

WARNING: This equipment has been tested and found to comply with the limits for a Class B digital device, pursuant to Part 15 of the FCC Rules. These limits are designed to provide reasonable protection against harmful interference in a residential installation. This equipment generates, uses and can radiate radio frequency energy and, if not installed and used in accordance with the instructions, may cause harmful interference to radio communications. However, there is no guarantee that interference will not occur in a particular installation. If this equipment does cause harmful interference to radio or television reception, which can be determined by turning the equipment off and on, the user is encouraged to try to correct the interference by one or more of the following measures:

- Reorient or relocate the receiving antenna.
- Increase the separation between the equipment and receiver.
- Connect the equipment into an outlet on a circuit different from the one which the receiver is connected to.
- Consult the dealer or an experienced radio/TV technician for help.

The user may find the following booklet prepared by the Federal Communications Commission helpful:

The Interference Handbook

This booklet is available from the U.S. Government Printing Office, Washington, D.C. 20402. Stock No. 004-000-00345-4.



Industry Canada Notice (Applicable to Use Within Canada)

This device complies with Canadian RSS-210.

To prevent radio interference to the licensed service, this device is intended to be operated indoors and away from windows to provide maximum shielding. Equipment (or its transmit antenna) that is installed outdoors is subject to licensing.

The installer of this radio equipment must ensure that the antenna is located or pointed such that it does not emit RF field in excess of Health Canada limits for the general population; consult Safety Code 6, obtainable from Health Canada's web site www.hc-sc.gc.ca/rpb.

Avis de Conformité à la Réglementation d'Industrie Canada

Pour empêcher toute interférence aux services faisant l'objet d'une licence, cet appareil doit être utilisé à l'intérieur seulement et devrait être placé loin des fenêtres afin de fournir un écran de blindage maximal.

L'installateur du présent matériel radio doit s'assurer que l'antenne est située ou pointée de manière à ce que cette dernière n'émette pas de champs radioélectriques supérieurs aux limites spécifiées par Santé Canada pour le grand public; consulter le Code de sécurité 6, disponible sur le site Web de Santé Canada, à l'adresse suivante: www.hc-sc.gc.ca/rpb.

Safety Compliance Notice

This device has been tested and certified according to the following safety standards and is intended for use only in Information Technology Equipment which has been tested and certified to these or other equivalent standards:

- UL Standard 60950, 3rd Edition / CSA C22.2 No. 60950-00
- IEC 60950
- EN 60950