

# QA review draft1

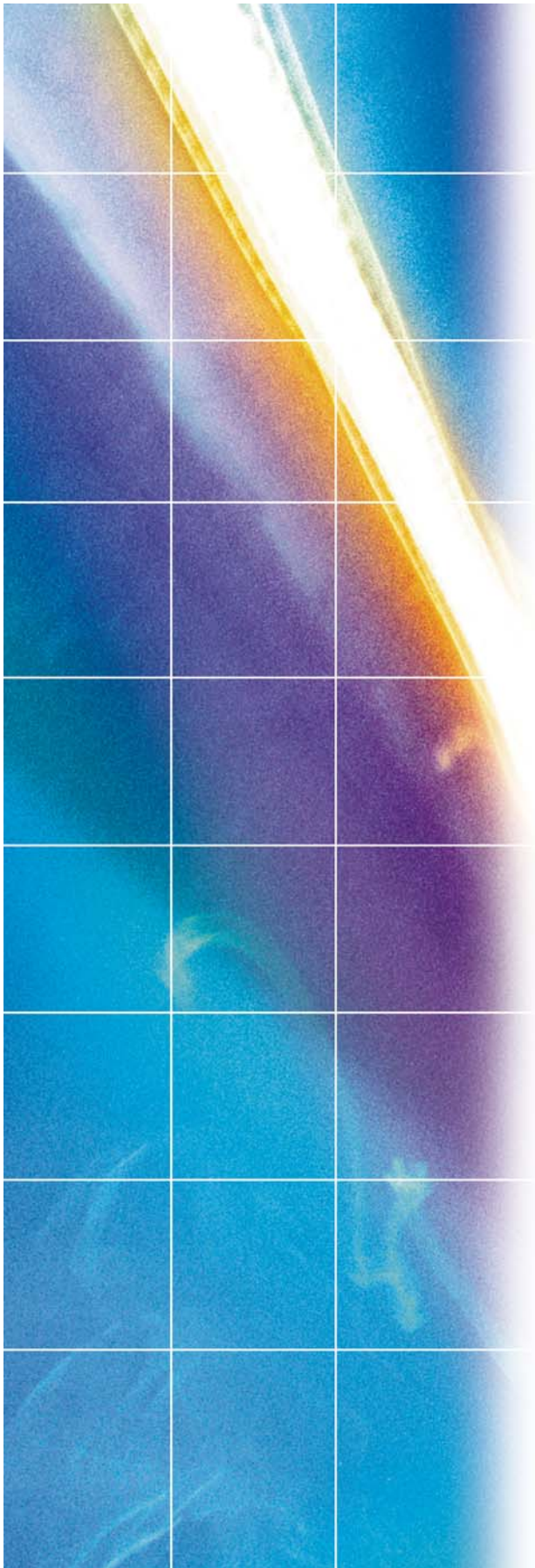

## **ES2440 High-Capacity Infrastructure Mesh Point**

**Hardware Guide**

## Fortress ES2440 High-Capacity Infrastructure Mesh Point [rev. 1]

Copyright © 2011 Fortress Technologies, Inc. All rights reserved.

This document contains proprietary information protected by copyright. No part of this document may be reproduced or transmitted in any form or by any means, electronic or mechanical, without written permission of Fortress Technologies, 2 Technology Park Drive, Westford, MA 01886-3140, except as specified in the Product Warranty and License Terms.

FORTRESS TECHNOLOGIES, INC., MAKES NO WARRANTY OF ANY KIND WITH REGARD TO THIS MATERIAL, INCLUDING BUT NOT LIMITED TO THE IMPLIED WARRANTIES OF MERCHANTABILITY AND FITNESS FOR A PARTICULAR PURPOSE. FORTRESS TECHNOLOGIES, INC. SHALL NOT BE LIABLE FOR ERRORS CONTAINED HEREIN OR FOR INCIDENTAL OR CONSEQUENTIAL DAMAGES IN CONNECTION WITH THE FURNISHING, PERFORMANCE OR USE OF THIS MATERIAL. THE INFORMATION IN THIS DOCUMENT IS SUBJECT TO CHANGE WITHOUT NOTICE.

The Fortress Technologies and AirFortress logos and AirFortress and are registered trademarks; Multi-Factor Authentication, Unified Security Model, Wireless Link Layer Security and Three Factor Authentication (TFA) are trademarks of Fortress Technologies, Inc. The technology behind Wireless Link Layer Security™ enjoys U.S. and international patent protection under patent number 5,757,924.

All trademarks mentioned in this document are the property of their respective owners.

### IMPORTANT SAFETY INFORMATION

The ES2440 is an outdoor device. It should be powered by PoE (Power over Ethernet) using a weatherized Ethernet cable. A mid-span PoE injector is provided with the ES2440. This mid-span PoE injector, as well as the power supply/adaptor used to power that injector, should remain indoors, protected from the weather. From the mid-span PoE injector, a weatherized Ethernet cable should be run to the outdoor ES2440. In this way, power can be safely provided to the outdoor ES2440 while the power supply and injector remain protected indoors, as shown:

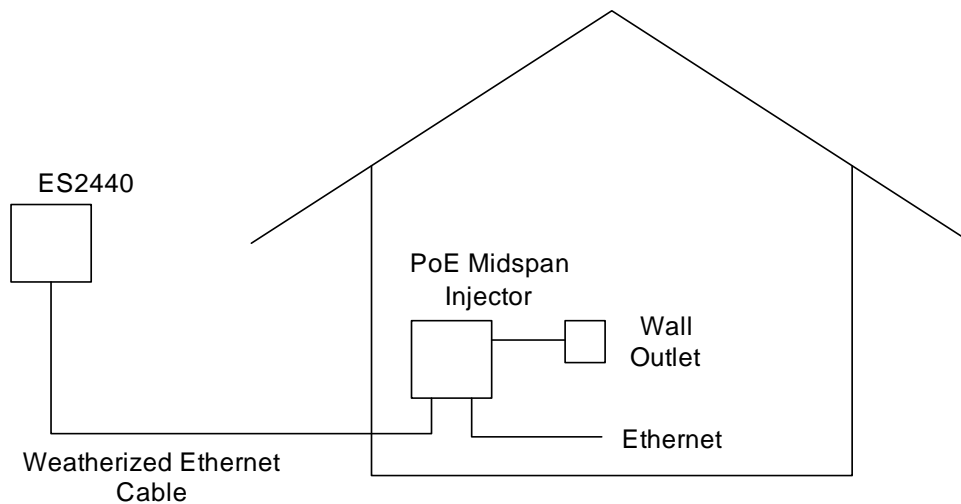

The power port on the ES2440 should not be used; it is reserved for future expansion.

## IMPORTANT FCC INFORMATION

The Federal Communications Commission has released Office of Engineering and Technology Laboratory Division Knowledge Database (KDB) 44399, which refines the definition of Dynamic Frequency Selection (DFS) support. Since this device has the ability to use frequencies covered by DFS, KDB 443999 must be followed. It is published in full on the FCC web site:

<https://apps.fcc.gov/oetcf/kdb/forms/FTSSearchResultPage.cfm?switch=P&id=41732>

In order to support FCC KDB 443999, Fortress has limited the use of certain frequencies within the 5400–5725 MHz range. Specifically, the frequencies defined by the FCC as being of primary interest are those in the 5600–5650 MHz range, which correspond to 802.11a channels 120, 124, and 128. In order to comply with the KDB 443999, these channels have been removed from use, or *notched*. Notched channels are unavailable for use on this device.

KDB 44399 provides additional restrictions on the use of channels within 30 MHz of notched channels when the device is within 35 km of a Terminal Doppler Weather Radar (TDWR) installation. Affected channels 116, 132, and 136 serve as a *guard* of 30 MHz around the critical notched frequencies. Guard frequencies are unavailable for use on this device by default. The FCC allows these channels to be used, however, as long as the device is not within 35 km of a TDWR installation, as described in this excerpt of KDB 443999:

Any installation of either a master or a client device within 35 km of a TDWR location shall be separated by at least 30 MHz (center-to-center) from the TDWR operating frequency.

In some instances it is possible that a device may be within 35 km of multiple TDWRs. In this case the device must ensure that it avoids operation within 30 MHz for each of the TDWRs. This requirement applies even if the master is outside the 35 km radius but communicates with outdoor clients which may be within the 35 km radius of the TDWRs.

The requirement for ensuring 30 MHz frequency separation is based on the best information available to date. If interference is not eliminated, a distance limitation based on line-of-sight from TDWR will need to be used.

Please refer to the original KDB 443999 as posted on the FCC web site for the complete text.

In order to enable channels 116, 132, and/or 136, please contact Fortress to obtain a special license. This license will be issued after it is confirmed that the installation is not within 30 MHz and 35 km of registered TDWR sites. The following table (provided by the FCC in KDB 443999 published on 10/14/2010) describes the locations of TDWR sites, as well as the frequencies at which these sites operate:

TDWR Location Information				FREQUENCY	TERRAIN ELEVATION (MSL) [ft]	ANTENNA HEIGHT ABOVE TERRAIN [ft]
STATE	CITY	LONGITUDE	LATITUDE			
AZ	PHOENIX	W 112 09 46	N 33 25 14	5610 MHz	1024	64
CO	DENVER	W 104 31 35	N 39 43 39	5615 MHz	5643	64
FL	FT LAUDERDALE	W 080 20 39	N 26 08 36	5645 MHz	7	113
FL	MIAMI	W 080 29 28	N 25 45 27	5605 MHz	10	113
FL	ORLANDO	W 081 19 33	N 28 20 37	5640 MHz	72	97
FL	TAMPA	W 082 31 04	N 27 51 35	5620 MHz	14	80
FL	WEST PALM BEACH	W 080 16 23	N 26 41 17	5615 MHz	20	113
GA	ATLANTA	W 084 15 44	N 33 38 48	5615 MHz	962	113
IL	MCCOOK	W 087 51 31	N 41 47 50	5615 MHz	646	97
IL	CRESTWOOD	W 087 43 47	N 41 39 05	5645 MHz	663	113
IN	INDIANAPOLIS	W 086 26 08	N 39 38 14	5605 MHz	751	97
KS	WICHITA	W 097 26 13	N 37 30 26	5603 MHz	1270	80
KY	COVINGTON CINCINNATI	W 084 34 48	N 38 53 53	5610 MHz	942	97
KY	LOUISVILLE	W 085 36 38	N 38 02 45	5646 MHz	617	113
LA	NEW ORLEANS	W 090 24 11	N 30 01 18	5645 MHz	2	97

TDWR Location Information				FREQUENCY	TERRAIN ELEVATION (MSL) [ft]	ANTENNA HEIGHT ABOVE TERRAIN [ft]
STATE	CITY	LONGITUDE	LATITUDE			
MA	BOSTON	W 070 56 01	N 42 09 30	5610 MHz	151	113
MD	BRANDYWINE	W 076 50 42	N 38 41 43	5635 MHz	233	113
MD	BENFIELD	W 076 37 48	N 39 05 23	5645 MHz	184	113
MD	CLINTON	W 076 57 43	N 38 45 32	5615 MHz	249	97
MI	DETROIT	W 083 30 54	N 42 06 40	5615 MHz	656	113
MN	MINNEAPOLIS	W 092 55 58	N 44 52 17	5610 MHz	1040	80
MO	KANSAS CITY	W 094 44 31	N 39 29 55	5605 MHz	1040	64
MO	SAINT LOUIS	W 090 29 21	N 38 48 20	5610 MHz	551	97
MS	DESOTO COUNTY	W 089 59 33	N 34 53 45	5610 MHz	371	113
NC	CHARLOTTE	W 080 53 06	N 35 20 14	5608 MHz	757	113
NC	RALEIGH DURHAM	W 078 41 50	N 36 00 07	5647 MHz	400	113
NJ	WOODBIDGE	W 074 16 13	N 40 35 37	5620 MHz	19	113
NJ	PENNSAUKEN	W 075 04 12	N 39 56 57	5610 MHz	39	113
NV	LAS VEGAS	W 115 00 26	N 36 08 37	5645 MHz	1995	64
NY	FLOYD BENNETT FIELD	W 073 52 49	N 40 35 20	5647 MHz	8	97
OH	DAYTON	W 084 07 23	N 40 01 19	5640 MHz	922	97
OH	CLEVELAND	W 082 00 28	N 41 17 23	5645 MHz	817	113
OH	COLUMBUS	W 082 42 55	N 40 00 20	5605 MHz	1037	113
OK	AERO. CTR TDWR #1	W 097 37 31	N 35 24 19	5610 MHz	1285	80
OK	AERO. CTR TDWR #2	W 097 37 43	N 35 23 34	5620 MHz	1293	97
OK	TULSA	W 095 49 34	N 36 04 14	5605 MHz	712	113
OK	OKLAHOMA CITY	W 097 30 36	N 35 16 34	5603 MHz	1195	64
PA	HANOVER	W 080 29 10	N 40 30 05	5615 MHz	1266	113
PR	SAN JUAN	W 066 10 46	N 18 28 26	5610 MHz	59	113
TN	NASHVILLE	W 086 39 42	N 35 58 47	5605 MHz	722	97
TX	HOUSTON INTERCNTL	W 095 34 01	N 30 03 54	5605 MHz	154	97

In addition, the FCC recommends that all operators and installers register with the WISPA database used by government agencies to quickly find devices that may be causing interference and notify their owners/operators to shut them down. This registration is not required, but Fortress strongly recommends that all systems be registered, as described in this excerpt of KDB 44399:

A voluntary WISPA sponsored database has been developed that allows operators and installers to register the location information of the UNII devices operating outdoors in the 5470 – 5725 MHz band within 35 km of any TDWR location (see <http://www.spectrumbridge.com/udia/home.aspx>). This database may be used by government agencies in order to expedite resolution of any interference to TDWRs.

KDB 443999 further specifies that the requirements of KDB 594280 must also be met.

KDB 594280 is published in full on the FCC web site:

<https://apps.fcc.gov/oetcf/kdb/forms/FTSSearchResultPage.cfm?switch=P&id=39498>.

This device meets KDB 594280 by not allowing any configuration options to be made such that the device could be taken out of compliance. There is no ability for the user to change country codes or to select power levels that would take the device out of compliance.

For customers such as the U.S. military or others willing to produce evidence that particular devices will be used only outside of the United States, a special license can be obtained from Fortress that will allow those devices the option of selecting a different, non-U.S. country code. Fortress creates such licenses only for those customers who offer proof of non-U.S. device usage, and licenses are specific to particular devices and are not transferrable. Devices having such a

license should NOT be considered to be compliant with FCC regulatory requirements. Please contact Fortress with questions about these special licences.

Only software that has been signed by Fortress using the Fortress private key can be loaded onto a Fortress device, thus insuring that no software other than that which is controlled and signed by Fortress can be loaded onto the device.

---

## FCC EMISSIONS COMPLIANCE AND INDUSTRY CANADA STATEMENTS

THIS EQUIPMENT HAS BEEN TESTED AND FOUND TO COMPLY WITH THE LIMITS FOR A CLASS B DIGITAL DEVICE, PURSUANT TO PART 15 OF THE FCC RULES. THESE LIMITS ARE DESIGNED TO PROVIDE REASONABLE PROTECTION AGAINST HARMFUL INTERFERENCE IN A RESIDENTIAL INSTALLATION. THIS EQUIPMENT GENERATES, USES, AND CAN RADIATE RADIO FREQUENCY ENERGY AND, IF NOT INSTALLED AND USED IN ACCORDANCE WITH THE INSTRUCTIONS, MAY CAUSE HARMFUL INTERFERENCE TO RADIO COMMUNICATIONS. HOWEVER, THERE IS NO GUARANTEE THAT INTERFERENCE WILL NOT OCCUR IN A PARTICULAR INSTALLATION. IF THIS EQUIPMENT DOES CAUSE HARMFUL INTERFERENCE TO RADIO OR TELEVISION RECEPTION, WHICH CAN BE DETERMINED BY TURNING THE EQUIPMENT OFF AND ON, THE USER IS ENCOURAGED TO TRY TO CORRECT THE INTERFERENCE BY ONE OR MORE OF THE FOLLOWING MEASURES:

- REORIENT OR RELOCATE THE RECEIVING ANTENNA.
- INCREASE THE SEPARATION BETWEEN THE EQUIPMENT AND THE RECEIVER.
- CONNECT THE EQUIPMENT INTO AN OUTLET ON A CIRCUIT DIFFERENT FROM THAT TO WHICH THE RECEIVER IS CONNECTED.
- CONSULT THE DEALER OR AN EXPERIENCED RADIO/TV TECHNICIAN FOR HELP.

YOU MAY ALSO FIND HELPFUL THE FOLLOWING BOOKLET, PREPARED BY THE FCC: "HOW TO IDENTIFY AND RESOLVE RADIOTV INTERFERENCE PROBLEMS." THIS BOOKLET IS AVAILABLE FROM THE U.S. GOVERNMENT PRINTING OFFICE, WASHINGTON, D.C. 20402

CHANGES AND MODIFICATIONS NOT EXPRESSLY APPROVED BY THE MANUFACTURER OR REGISTRANT OF THIS EQUIPMENT CAN VOID YOUR AUTHORITY TO OPERATE THIS EQUIPMENT UNDER FEDERAL COMMUNICATIONS COMMISSION RULES. IN ORDER TO MAINTAIN COMPLIANCE WITH FCC REGULATIONS, SHIELDED CABLES MUST BE USED WITH THIS EQUIPMENT. OPERATION WITH NON-APPROVED EQUIPMENT OR UNSHIELDED CABLES IS LIKELY TO RESULT IN INTERFERENCE TO RADIO AND TELEVISION RECEPTION.

IN ADDITION, USERS SHOULD ALSO BE CAUTIONED TO TAKE NOTE THAT HIGH POWER RADARS ARE ALLOCATED AS PRIMARY USERS



(MEANING THEY HAVE PRIORITY) OF 5250-5350 MHZ AND 5650-5850 MHZ AND THESE RADARS COULD CAUSE INTERFERENCE AND/OR DAMAGE TO LE-LAN DEVICES.

ICES-003 STATEMENT:

THIS CLASS B DIGITAL APPARATUS COMPLIES WITH CANADIAN ICES-003.

CET APPAREIL NUMÉRIQUE DE LA CLASSE B EST CONFORME À LA NORME NMB-003 DU CANADA.

---

THIS DEVICE HAS BEEN DESIGNED TO OPERATE WITH THE ANTENNAS HAVING A MAXIMUM GAIN OF 9 DB. ANTENNAS HAVING A GAIN GREATER THAN 9 DB ARE STRICTLY PROHIBITED FOR USE WITH THIS DEVICE. THE REQUIRED ANTENNA IMPEDANCE IS 50 OHMS.

OPERATION IS SUBJECT TO THE FOLLOWING TWO CONDITIONS: (1) THIS DEVICE MAY NOT CAUSE INTERFERENCE, AND (2) THIS DEVICE MUST ACCEPT ANY INTERFERENCE, INCLUDING INTERFERENCE THAT MAY CAUSE UNDESIRE OPERATION OF THE DEVICE.

TO REDUCE POTENTIAL RADIO INTERFERENCE TO OTHER USERS, THE ANTENNA TYPE AND ITS GAIN SHOULD BE SO CHOSEN THAT THE EQUIVALENT ISOTROPICALLY RADIATED POWER (E.I.R.P.) IS NOT MORE THAN THAT PERMITTED FOR SUCCESSFUL COMMUNICATION.

---

#### ANTENNA RESTRICTIONS

THIS DEVICE HAS BEEN DESIGNED TO HAVE A MAXIMUM GAIN OF 9 DBI. ANTENNAS HAVING A GAIN GREATER THAN 9 DBI ARE STRICTLY PROHIBITED FOR USE WITH THIS DEVICE. THE REQUIRED ANTENNA IMPEDANCE IS 50 OHMS.

THIS PRODUCT IS NOT CAPABLE OF OPERATING IN THE 5600MHZ – 5650MHZ RANGE.

THIS PRODUCT MUST BE OPERATED NO CLOSER THAN 20CM TO THE HUMAN BODY.

---

**⚠ CAUTION:** 4.4 GHZ MILITARY BAND RADIOS ARE OPTIONAL EQUIPMENT IN THE ES2440. THE 4.400 GHZ–4.750 GHZ FREQUENCY RANGE IS REGULATED BY THE UNITED STATES DEPARTMENT OF DEFENSE. THE FCC HAS NO REGULATORY OVERSIGHT OR JURISDICTION ON PRODUCTS CONTAINING RADIOS THAT OPERATE IN THIS RANGE. USE OF 4.4 GHZ RADIOS IS STRICTLY FORBIDDEN OUTSIDE OF U.S. MILITARY APPLICATIONS AND AUTHORITY.

## Table of Contents

---

<b>1</b>		
<b>Overview</b>		<b>1</b>
<hr/>		
This Document . . . . .		1
Related Documents . . . . .		1
The ES2440 . . . . .		2
Hardware Models . . . . .		2
Shipped Parts . . . . .		2
<b>2</b>		
<b>Installation</b>		<b>4</b>
<hr/>		
Preparation . . . . .		4
Safety Requirements . . . . .		4
Powering Options . . . . .		5
Port and Grounding Stud Locations . . . . .		6
Connecting the ES2440 . . . . .		7
Connections for Preconfiguration . . . . .		7
Connections for Deployment . . . . .		8
Mast Mounting the ES2440 . . . . .		8
<b>3</b>		
<b>LEDs and Button Operation</b>		<b>10</b>
<hr/>		
Front-Panel LED Indicators . . . . .		10
Recessed Button Operation . . . . .		11



4		
Specifications		12
<hr/>		
Hardware Specifications . . . . .		12
Physical Specifications . . . . .		12
Environmental Specifications . . . . .		12
Compliance and Standards . . . . .		13
RJ45-to-DB9 Serial Port Adapter . . . . .		13
2-Pin DC Input Connector . . . . .		14
Index		I
<hr/>		



# Chapter 1

## Overview

---

### 1.1 This Document

This user guide covers preparing and installing the Fortress ES2440 High-Capacity Infrastructure Mesh Point hardware. It also describes the LED indicators and recessed button operation and provides specifications. Other Fortress hardware devices are covered in separate hardware guides, one for each Mesh Point (or Network Encryptor) model.

Fortress Mesh Point user guidance is intended for professional system and network administrators and assumes that its users have a level of technical expertise consistent with these roles.

Side notes throughout this document are intended to alert you to particular kinds of information, as visually indicated by their icons. Examples appear to the right of this section, in descending order of urgency.

 **WARNING:** can cause physical injury or death and/or severely damage your equipment.

---

 **CAUTION:** can corrupt your network, your data or an intended result.

---

#### 1.1.1 Related Documents

Each Fortress hardware series runs the same Fortress software, and differences between ES and FC series software are minor. Fortress software user guidance covers all current Fortress hardware platforms.

Fortress Mesh Point software guides include:

- ◆ *Mesh Point and Network Encryptor Software GUI Guide*
- ◆ *Mesh Point and Network Encryptor Software CLI Guide*
- ◆ *Mesh Point and Network Encryptor Software Auto Configuration Guide*

In addition to this guide, the Fortress hardware guides include:

- ◆ *ES210 Tactical Mesh Point Hardware Guide*
- ◆ *ES440 Infrastructure Mesh Point Hardware Guide*
- ◆ *ES520 Deployable Mesh Point Hardware Guide*
- ◆ *ES820 Vehicle Mesh Point Hardware Guide*
- ◆ *FC-X Inline Network Encryptor Hardware Guide*

 **NOTE:** may assist you in executing the task, e.g. a convenient software feature or notice of something to keep in mind.

---

## 1.2 The ES2440

The ES2440 High-Capacity Infrastructure Mesh Point is a full-featured Fortress network device, providing strong data encryption and Multi-factor Authentication™, including native RADIUS authentication, to users and devices on the network it secures.

The ES2440 contains four radios:

- ◆ *Radio 1* is a 250 mW (milliwatt) dual-band 802.11a/b/g/n radio that can be configured to use either the 802.11b/g band or the 802.11a band, with an option for 802.11n capability in either band.
- ◆ Standard equipment *Radio 2*, *Radio 3* and *Radio 4* are 500mW radios fixed on the 802.11a band, also with an option for 802.11n capability. The ES2440 can be optionally equipped with three 800mW 802.11a/n 4.4 GHz military band radios in place of the standard equipment *Radios 2*, *3*, and *4*.

Any of the ES2440's radios can function as a wireless access point (AP), providing secure WLAN connectivity to wireless devices within range and as a wireless bridge or node in a mesh network.

The ES2440 is additionally equipped with an internal global positioning system (GPS) receiver.

### 1.2.1 Hardware Models

You can identify by the full model number of the ES2440 whether it is equipped with standard 5 GHz 802.11a radios (as *Radios 2*, *3* and *4*) or with 4.4 GHz military band radios.

- ◆ ES2440-3555 - standard equipment
- ◆ ES2440-3444 - military option

The 4.400 GHz–4.750 GHz frequency range is regulated by the United States Department of Defense, rather than the Federal Communications Commission (FCC). FCC markings are therefore not applied to the ES2440-3444 chassis and there is no FCC ID associated with these products.

Each model is equipped with the appropriate antenna port (**ANT2**) for the type of radio installed as *Radio 2*.

The two ES2440 models are otherwise identical.

### 1.2.2 Shipped Parts

These items are included in shipments of the ES2440 (Fortress part numbers in parentheses):

- ◆ one ES2440 Mesh Point (*part # 810-00037-01*)
- ◆ one DB9-to-RJ45 serial adapter (*part # 139-00002-01*)
- ◆ one 60W passive POE+ adapter/injector, gigabit compatible (*part # 270-00139-01*)

 **CAUTION:** Use of 4.4 GHz radios is strictly forbidden outside of U.S. Department of Defense authority.

---

- ◆ one AC power cord (*part # 620-00016-01*)
- ◆ three weatherized Ethernet shell connectors (*part # 200-00229-01*)
- ◆ one mast mounting kit (*part # 381-00004-01*)
- ◆ software CD, including:
  - ❖ ES2440 Mesh Point software package
  - ❖ Fortress and standard SNMP MIBs
  - ❖ RADIUS dictionary file with Fortress Vendor-Specific Attributes for administrative authentication
  - ❖ ES2440 Mesh Point user guides and latest release notes

## Chapter 2

# Installation

---

### 2.1 Preparation

Before proceeding with installation, review the safety information in Section 2.1.1 below.

#### 2.1.1 Safety Requirements

To prevent damage to the product and ensure your personal safety, operate the Mesh Point only within the operating specifications given in Section 4.1.2, and carefully follow these guidelines:

- ◆ *General:* This equipment must be installed by qualified service personnel according to the applicable installation codes. Do not locate the Mesh Point or antennas near power lines or power circuits. When installing an external antenna, take extreme care not to come into contact with such circuits as they can cause serious injury or death. Avoid metal ladders wherever possible. For proper installation and grounding, refer to national and/or local codes (WSNFPA 70 or, Canadian Electrical Code 54).
- ◆ *Indoor/Outdoor Siting:* All interconnected equipment connected to the Mesh Point must be contained within the same building, including the interconnected equipment's associated LAN connections.
- ◆ *Ambient Temperature:* The temperature of the environment in which the Mesh Point operates should not exceed the maximum (158° F/70° C) or drop below the minimum (-40° F/-40° C) operating temperatures.
- ◆ *Circuit Overloading:* The ES2440 version Mesh Point includes an internal 48V resettable fuse.
- ◆ *Powering:* The Mesh Point can be direct powered by 10–30 VDC or by 802.3at POE+ (Power over Ethernet Plus). The ES2440 will work with any active 802.3at or passive 60W midspan device, but will not be able to interoperate directly to 25W endspan switches without the use of a midspan power injector.

- ◆ **Grounding:** Ground the ES2440 by connecting a ground wire to the grounding stud located on the left rear corner of the chassis (refer to Figure 2.1).
- ◆ **Radio Frequency:** The Mesh Point's internal radios conform to the FCC's safety standard for human exposure to RF electromagnetic energy, provided that you follow these guidelines:
  - ❖ Do not touch or move the antennas while the unit is transmitting or receiving.
  - ❖ To safeguard Mesh Point transmitting circuitry, relocate the Mesh Point and its antennas only when the Mesh Point is powered off.
  - ❖ When the Mesh Point is transmitting, do not hold it so that the antenna is very close to or touching any exposed parts of the body, especially the face or eyes.
  - ❖ Antennas must be installed to provide a separation of at least 20 cm (7.9") from all persons and any co-located antenna or transmitter.
  - ❖ Regarding use in specific environments:
    - Do not operate near unshielded blasting caps or in an explosive environment.
    - Limit use in a hazardous location to the constraints imposed by the location's safety director.
    - Abide by the rules of the Federal Aviation Administration for the use of wireless devices on airplanes.
    - Restrict the use of wireless devices in hospitals to the limits set forth by each hospital.

 **WARNING:** If the Mesh Point connects to outside-mounted antennas, failure to provide a low resistive earth ground can result in migration of voltage from lightning or line surges onto the premises wiring, which can cause electric shock and/or fire within the building or structure.

---

## 2.1.2

### Powering Options

The ES2440 Mesh Point can be powered by 802.3at PoE+ (Power over Ethernet Plus), with the adapter/injector and power cord included in each shipment, or by 10–30 VDC (volts direct current), with a user-provided connector/cord assembly.

The external DC power option is **not** intended to be a redundant back-up supply to PoE (or vice versa). The ES2440 will automatically disconnect PoE if external DC power is applied and will only reconnect PoE when DC power is removed. When either PoE or external DC are removed, the ES2440 will reboot.

#### ***To power the ES2440 over Ethernet***

Plug the included PoE+ adapter/injector into a properly rated AC outlet using the power cord provided, and connect the adapter to the ES2440's **Ethernet1/WAN/POE** port (refer to Figure 2.1) with a standard Cat5 Ethernet cable.

#### ***To power the ES2440 with external DC***

To power the ES2440 via the front-panel the 2-pin **DC Power** inlet, you must first obtain a suitable mating cable-end socket connector and attach it according to the pin-outs described in Section 4.3 to a cable of the correct length and gauge for your

 **CAUTION:** Never plug the ES2440 into a PoE adapter other than the adapter included in the shipment (or a replacement obtained from Fortress). Using the wrong power adapter can damage the ES2440.

---

 **NOTE:** The ES2440 will work with any active 802.3at or passive 60W midspan device but will not be able to inter-operate directly to 25W endspan switches without the use of a midspan power injector.

---

deployment. Use the resulting connector/cord assembly to connect the ES2440 to an external 30 VDC power source.

### 2.1.3 Port and Grounding Stud Locations

The ES2440 Mesh Point's **Serial** port and three Ethernet ports, **Ethernet1/WAN/POE**, **Ethernet2**, and **Ethernet3** are located on the front panel, along with the **DC Power** inlet and recessed **Reset** button (see Figure 2.1).

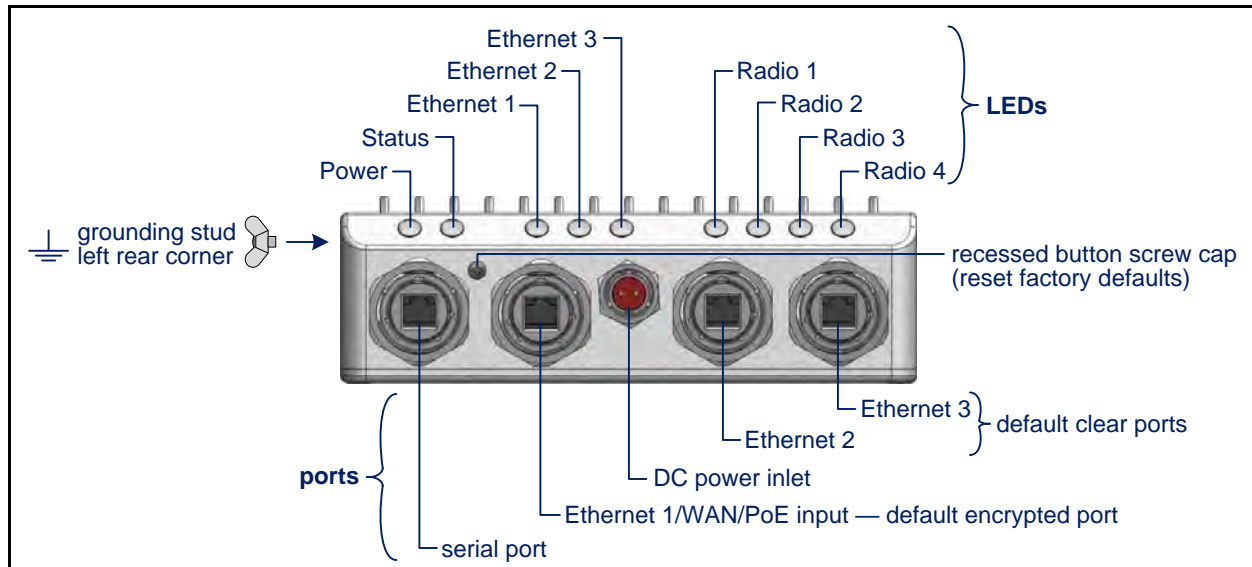

**Figure 2.1. ES2440 Front-Panel Ports, Reset Button, LEDs and Grounding Stud Location**

All ES2440 front-panel ports are protected by captive covers. Unused ports should remain covered to protect against dust and other debris. Covered or uncovered, all ES2440 ports are waterproof.

The recessed button used to restore the running configuration to factory defaults (Section 3.2) is also located on the front panel, beneath a protective screw cap.

The LEDs located above the ES2440's ports are described in Section 3.1

Nine antenna connectors are situated on the ES2440 back panel, eight corresponding, by pair, to the ES2440's four



internal radios, as shown below, and one for the ES2440 internal GPS.

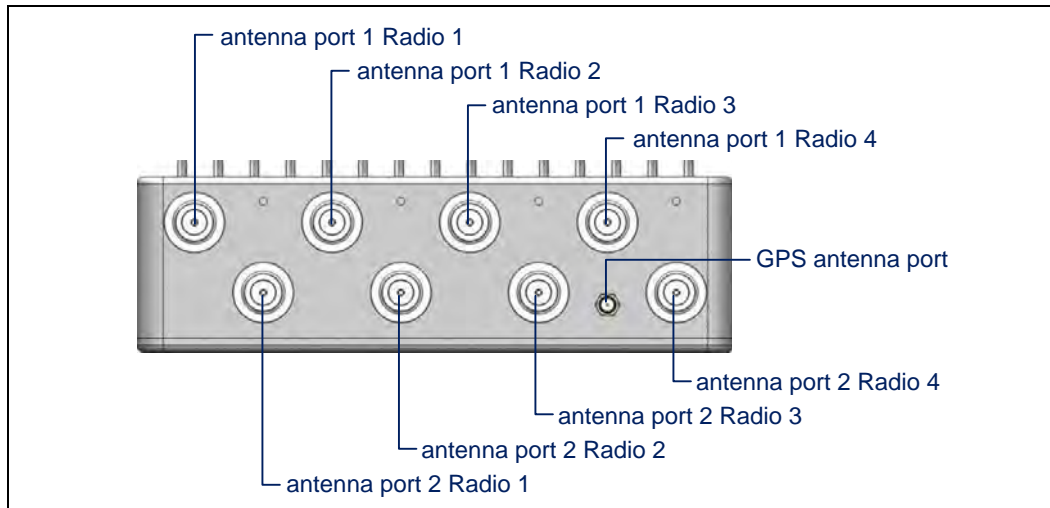

Figure 2.2. ES2440 Back-Panel Antenna Connectors

The grounding stud is the wing nut located on the left rear corner of the chassis, viewing the ES2440 from the front (refer to Figure 2.1),

## 2.2 Connecting the ES2440

The ES2440 can be connected temporarily to preconfigure the Mesh Point software, and then permanently for deployment.

### 2.2.1 Connections for Preconfiguration

Mesh Point software should be configured in advance of deployment. This section provides instructions for temporarily connecting the ES2440 Mesh Point for preconfiguration.

- 1 Position the Mesh Point so that it operates only within its safe temperature range.
- 2 Connect the Mesh Point to a power source, either through the **Ethernet1/WAN/POE** port using the included PoE+ adapter/injector or through the **DC Power** inlet to external 10–30 VDC power. Refer to Section 2.1.2, Powering Options, for additional detail.
- 3 Connect an Ethernet cable to one of the ES2440's default clear Ethernet ports: **Ethernet2** or **Ethernet3**, and connect the other end to a computer or a switch on the wired LAN.

To complete the configuration, refer to the *Software GUI Guide* or the *Software CLI Guide* for instructions on Logging On, Licensing, and Configuring the Mesh Point software.

## 2.2.2 Connections for Deployment

Review the Safety Requirements in (Section 2.1.1) before installing or operating the ES2440.

- 1 Ground the ES2440 by connecting a ground wire to the ES2440's grounding stud located on the left rear corner of the chassis (refer to Figure 2.1).
- 2 If your deployment uses Radio 1, connect a standard 2.4 GHz- or 5 GHz-capable antenna with an N-type male connector, to antenna port 1 (Ant1).

If your deployment uses Radio 2, 3, and/or 4, connect an antenna cable with a N-type male connector between the appropriate antenna port(s) (see Figure 2.2) and a high-gain omnidirectional or directional antenna.

If the Mesh Point or its antenna(s) will be located outside, the antenna(s) must be waterproof.

Antennas used with the ES2440 must have a maximum gain of 9 dBi and 50 Ohms impedance.

- 3 If the Mesh Point's GPS function will be used, connect an SMA GPS antenna to the **GPS** antenna port.
- 4 If your deployment includes Ethernet connections, make them now, using standard Cat5e cable(s), to **Ethernet1/WAN/POE** (default encrypted), **Ethernet2** and/or **Ethernet3** (both default clear).
- 5 Connect the Mesh Point (or verify its connection to) to the power source it will use.
- 6 Verify that the **Power** and **Status** LEDs illuminate, as well as the corresponding LEDs for all connected ports and enabled radio(s).

LED indicators are covered in Section 3.1

 **WARNING:** To comply with FCC regulations, antennas must be professionally installed and the installer is responsible for ensuring compliance with FCC limits.

---

 **CAUTION:** The FCC requires co-located radio antennas to be at least 7.9" apart. The Mesh Point's antenna connectors are closer than this. Avoid directly mounting two or more antennas to the Mesh Point's rear-panel connectors.

---

## 2.3 Mast Mounting the ES2440

The Mast-Mounting Kit accommodates masts from 1.5" to 3" in diameter.

- 1 Fit the two hex bolts through the center mounting holes along the Mesh Point's sides, top to bottom.
- 2 Fix each bolt to the Mesh Point chassis with a split-lock washer followed by a wing nut, tightened securely to the underside of the Mesh Point.
- 3 Position the Mesh Point at the desired position on the mast, with the Mesh Point's underside facing toward the mast and the front panel facing down, as shown in Figure 2.3.
- 4 Sandwiching the mast between the underside of the Mesh Point and the mounting bracket, fit the mast into the toothed cut-outs in the mounting bracket and the bolt shafts

extending from the Mesh Point through the holes in the bracket.

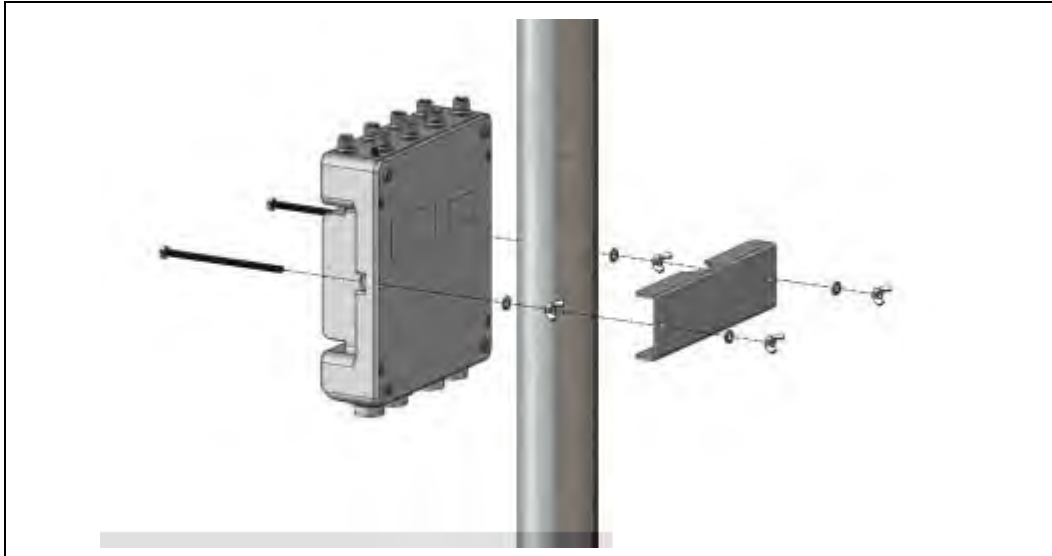

**Figure 2.3. Mast mounting the ES2440**

- 5 Place a slip-lock washer and then a wing nut on each of the bolt ends, and tighten the nuts until the washers are flattened against the mounting bracket.

# Chapter 3

## LEDs and Button Operation

### 3.1 Front-Panel LED Indicators

The ES2440 Mesh Point features nine LEDs on the front panel (shown in Figure 2.1).

**Power *can exhibit:***

- ◆ *solid green* - Mesh Point is powered on and operating normally.
- ◆ *off* - Mesh Point is powered off.
- ◆ *slow-flash green* - Mesh Point is booting.

**Status *can exhibit:***

- ◆ *intermittent green* - Cleartext is passing on an encrypted port.

**Ethernet1, Ethernet2, Ethernet3 *can exhibit:***

- ◆ *solid green* - Link has been established.
- ◆ *intermittent green* - Traffic is passing on the port.

**Radio1, Radio2, Radio3 *and* Radio4 *can exhibit:***

- ◆ *solid green* - Radio is on.
- ◆ *intermittent green* - Radio is passing traffic.
- ◆ *off* - Radio is off or Mesh Point's *RF Kill* function is enabled.

color	behavior	Power	Status	Ethernet1, Ethernet2, Ethernet3 Link/Act	Radio1, Radio2, Radio3, Radio4
<i>green</i>	<i>solid</i>	normal operation	-	link established	radio ON
	<i>slow flash</i>	booting	-	-	-
	<i>intermittent</i>	-	cleartext on encrypted port	passing traffic	passing traffic
<i>off</i>		powered OFF	-	-	radio OFF or RF Kill enabled

## 3.2 Recessed Button Operation

The single recessed button on the ES2440 front panel (shown in Figure 2.1) returns the ES2440 Mesh Point to the factory default configuration.

The button is covered by a screw cap that you must remove, in order to access the button. ***You must replace the screw cap, in order to maintain the watertight integrity of the ES2440 chassis.***

To restore default settings, depress and hold the button for 10 seconds. All current configuration information on the running boot partition will be lost.

## Chapter 4 Specifications

---

### 4.1 Hardware Specifications

#### 4.1.1 Physical Specifications

form factor:	mountable, compact, rugged chassis
dimensions:	2.75" H x 8.5" W x 9.5" D (6.99 cm x 21.59 cm x 24.13 cm)
weight:	7 lbs (3.18 kg)
power supply:	802.3at POE+ or 30 VDC
connections:	three RJ-45 10/100/1000 Mbps Ethernet ports with tethered caps one RJ-45 serial port with tethered cap eight N-type radio antenna ports (female) one SMA antenna port for GPS receiver (female, passive or active) one 10–30 VDC power input port with tethered cap
radios:	Radio1: 250 mW 802.11a/b/g/n Radio2, Radio3, and Radio4: 500 mW 802.11a/n or 800mW 802.11a/n 4.4GHz (military band)
indicators:	system and port LEDs: <b>Power, Status</b> <b>Ethernet1 Link/Act, Ethernet2 Link/Act, Ethernet3 Link/Act</b> <b>Radio1, Radio2, Radio3, Radio4</b>

#### 4.1.2 Environmental Specifications

power draw:	40 W Maximum
maximum heat dissipation:	160.48 BTUs
cooling:	Convection Cooled
operating temperature:	-40°–158° F (-40°–70° C)
operating relative humidity:	5%–95% (non-condensing)
storage temperature:	-40°–158° F (-40°–70° C)



### 4.1.3 Compliance and Standards

emissions/immunity:	CE, FCC, ETSI, CB Test, MIL-STD 464A, MIL-STD 461F
vibration:	MIL-STD 810G
weather resistance:	IP67 submersible

The Fortress ES2440 is certified by the Wi-Fi Alliance® for the following standards:

IEEE:	802.11a/b/g/n
security:	WPA™, WPA2™—Personal and Enterprise
EAP types:	EAP-TLS, EAP-TTLS/MSCHAPv2, PEAPv0/EAP-MSCHAPv2, PEAPv1/EAP-GTC, EAP-SIM, EAP-AKA, EAP-FAST

## 4.2 RJ45-to-DB9 Serial Port Adapter

An RJ45-to-DB9 adapter (included with each Mesh Point) is required in order to connect the Mesh Point’s serial port to a DB9 terminal connection.

Figure 4.1 shows the pin numbers for the two connectors. With the RJ45 connector facing you and oriented with the tab receptacle up, pins are numbered from right to left, as shown. With the DB9 connector facing you and oriented with the wide side up, pins are numbered from right to left, top to bottom.

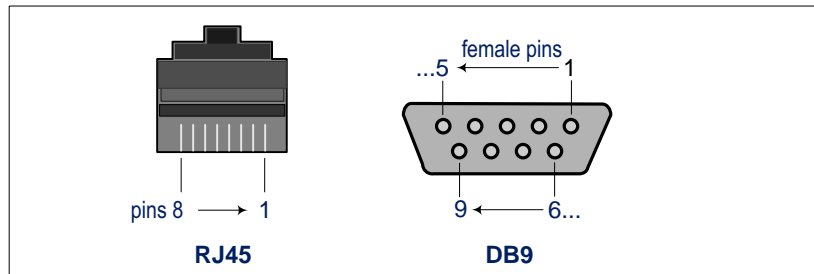

Figure 4.1. RJ45 and DB9 Pin Numbering

Table 4.1 shows the serial port adapter pin-outs.

Table 4.1. RJ45-to-DBP Adapter Pin-Outs

RJ45 pin	DB9 pin	standard color
1	8	grey
2	6	brown
3	2	yellow
4	5	green
5	-	red
6	3	black

Table 4.1. RJ45-to-DBP Adapter Pin-Outs

RJ45 pin	DB9 pin	standard color
7	4	orange
8	7	blue

### 4.3 2-Pin DC Input Connector

As described in Section 2.1.2, Powering Options, the connector-cable assembly to power the ES2440 through its weathertight 2-pin DC input is not included with the ES2440.

Mating connectors include the Amphenol® MIL-C-26482, Series 1, part #MS3116J10-2S, Miniature Cylindrical Connector. Figure 4.2 shows the pin numbers for mating connectors for the ES2440 DC Input.

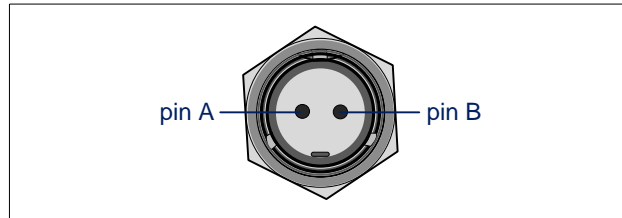

Figure 4.2. DC Input Power Connector Pins

You can obtain a mating connector from any vendor that supplies it.

Table 4.2 shows the DC power connector pin-outs.

Table 4.2. ES2440 DC Power Connector Pin-Outs

pin	signal
A	+10 to +30 VDC
B	Ground

The allowable input range for DC power is 10V–30V.

The gauge of wire required for the DC power cable depends on the length of the cable and the intended power source for the installation. Consult a qualified electrical contractor to establish the proper cable-gauge specification to ensure that the power and voltage level available to the ES2440 fall within the correct range.

## Index

---

### Numerics

---

- 4.4 GHz
  - see military band radios
- 802.11a/b/g/n
  - see radios
- 802.3at
  - see PoE

### A

---

- antennas
  - connecting 8
  - connector specifications 12
  - precautions 5, 6, 7, 8
  - restrictions v

### C

---

- compliance
  - Canada iv
  - FCC iii
  - standards 13

### D

---

- DB9-to-RJ-45 adapter 13–14
- DC power input 5–6, 7, 12
  - pin-outs 14
- dimensions 12

### E

---

- earthing 5, 6, 7, 8
- emissions iii, 13
- environmental specifications 12
- Ethernet
  - connecting 7, 8
  - LEDs 10
  - port locations 6
  - specifications 12
  - see *also* PoE

### F

---

- FCC
  - antenna restrictions v
  - emissions compliance iii
  - TDWR information i–iii
- fuse 4

### G

---

- GPS 2, 7, 8
- grounding 5, 6, 7, 8

### H

---

- hardware
  - mast mounting 3, 8–9
  - models 2
  - safety requirements 4–5
  - specifications 12–13

### I

---

- installation 7–8
  - safety requirements 4–5
- interference
  - see emissions

### M

---

- mast mounting 8–9
- military band radios v, 2, 12
- models 2

### O

---

- operating temperature 4, 12

### P

---

- PoE 5
  - connecting 7, 8
  - port location 6
  - specifications 5, 12
- ports
  - connecting 7, 8
  - LEDs 10
  - locations 6–7
  - specifications 12
- powering 4, 5–6, 8, 12
  - DC input 5–6, 7, 12, 14
  - PoE 5, 6, 7
- precautions
  - see safety

## R

---

radios 2

connecting antennas 7, 8

LEDs 10

precautions v, 2, 8

safety requirements 5

specifications 12

RJ-45-to-DB9 adapter 13–14

## S

---

safety

precautions 1, 5, 8

requirements 4–5

see *also* specifications

serial port

adapter 13–14

location 6

specifications 12–13

## T

---

TDWR i–iii

## V

---

VDC input 5–6

connecting 7

location 6

pin-outs 14

specifications 12

vibration 13