

lenovo[®]

Lenovo Yoga 3 14

User Guide



Read the safety notices and important tips in the included manuals before using your computer.

Notes

- Before using the product, be sure to read *Lenovo Safety and General Information Guide* first.
- Some instructions in this guide may assume that you are using Windows® 8.1. If you are using another Windows operating system, some operations may be slightly different. If you are using other operating systems, some operations may not apply to you.
- The features described in this guide are common to most models. Some features may not be available on your computer or your computer may include features that are not described in this user guide.
- The illustrations in this manual may differ from the actual product. Please refer to the actual product.

Regulatory Notice

- For details, refer to **Guides & Manuals** at <http://support.lenovo.com>.

First Edition (December 2014)

© Copyright Lenovo 2014.

LIMITED AND RESTRICTED RIGHTS NOTICE: If data or software is delivered pursuant to a General Services Administration "GSA" contract, use, reproduction, or disclosure is subject to restrictions set forth in Contract No. GS-35F-05925.

Contents

Chapter 1. Getting to know your computer	1
Top view	1
Left-side view	8
Right-side view	11
Bottom view	14
Chapter 2. Starting to use Windows 8.1	15
Configuring the operating system for the first time	15
Operating system interfaces	15
The charms	16
Putting the computer to sleep or shutting it down	19
Touch screen operation	22
Connecting to a wireless network	26
Help and support	27
Chapter 3. Lenovo OneKey Recovery system	28
Chapter 4. Troubleshooting	30
Frequently asked questions	30
Troubleshooting	33
Trademarks	36

Chapter 1. Getting to know your computer

■ ■ Top view

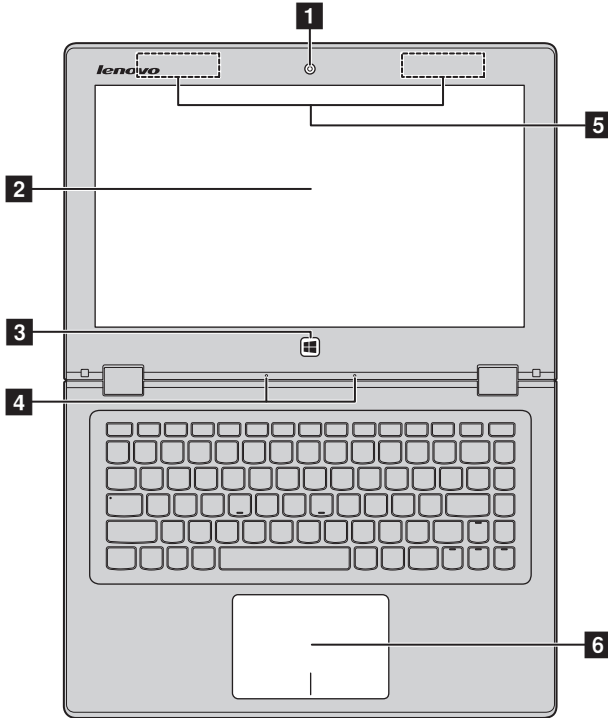

Note: The dashed areas indicate parts that are not visible externally.

⦿ Attention:

- When closing the display panel, be careful *not* to leave pens or any other objects in between the display panel and the keyboard. Otherwise, the display panel may be damaged.

Chapter 1. Getting to know your computer

- 1 Integrated camera (on select models)** Use the camera for video communication.
- 2 Multi-touch screen** The LCD display with LED backlight provides brilliant visual output. Multi-touch function is available on this display.
- 3 Windows button** Press this button to:
Toggle between the current view and the Start screen.
-or-
Wake up the computer from sleep mode.
- 4 Built-in microphones** Capture sound which can be used for video conferencing, voice narration, or audio recording.
- 5 Wireless LAN antennas** Connect to a wireless LAN adapter to send and receive wireless radio signals.
- 6 Touch pad** The touch pad functions as a conventional mouse.

Touch pad: To move the pointer on the screen, slide your fingertip over the pad in the direction in which you want the pointer to move.
Touch pad buttons: The functions of the left/right side correspond to those of the left/right mouse button on a conventional mouse.









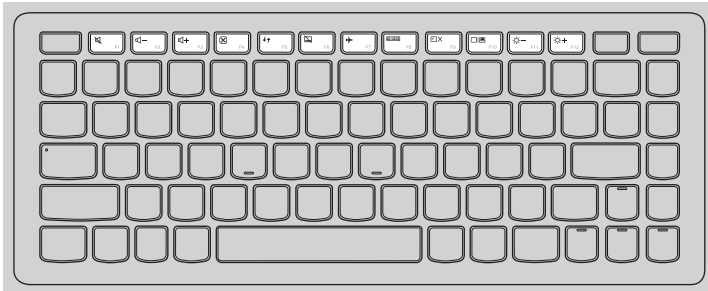



Note: You can enable/disable the touch pad by pressing F6 (.

■ Using the keyboard

Hotkeys

You can access certain system settings quickly by pressing the appropriate hotkeys.



 : Mutes/unmutes the sound.	 : Enables/disables Airplane mode.
 : Decreases the volume level.	 : Displays all currently active apps.
 : Increases the volume level.	 : Turns on/off the backlight of the LCD screen.
 : Closes the currently active window.	 : Toggles the display between the computer and an external device.
 : Refreshes the desktop or the currently active window.	 : Decreases display brightness.
 : Enables/disables the touch pad.	 : Increases display brightness.

Note: If you changed the **Hotkey Mode** from **Enabled** to **Disabled** in the BIOS setup utility, you will need to press the Fn key in combination with the appropriate hotkey.

Chapter 1. Getting to know your computer

Function key combinations

Through the use of the function keys, you can change operational features instantly. To use this function, press and hold **Fn** **1**; then press one of the function keys **2**.

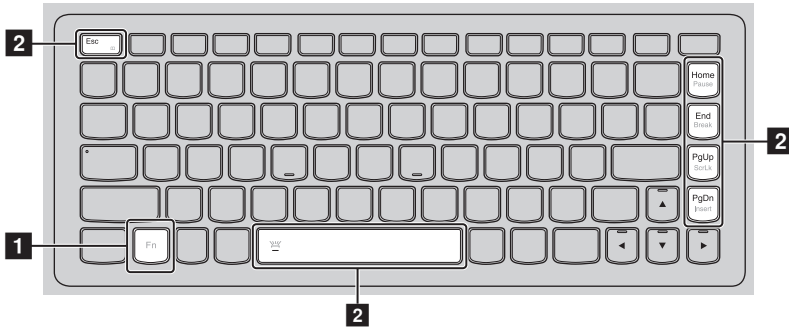

The following describes the features of each function key.

Fn + Esc: Switches to paper display mode.

Fn + Home: Activate the pause function.

Fn + End: Activate the break function.

Fn + PgUp: Enable/Disable the scroll lock.

Fn + PgDn: Activate the insert function.

**Fn + Space
(on select models):** Turn on/off the keyboard backlight.

Chapter 1. Getting to know your computer

■ Positioning the display panel

The display panel can be opened to any angle up to 360 degrees.



■ Notebook Mode



Suitable for tasks that require a keyboard and mouse (such as creating documents, writing e-mails, and so on).

Chapter 1. Getting to know your computer

Stand Mode (Theater Mode)



Suitable for tasks that require little or no touch (such as viewing photos or playing videos).

Tablet Mode



Suitable for tasks that require touching the screen often (such as surfing the Web, playing games, and so on).

Tent Mode (Presentation Mode)



Suitable for tasks that require limited interaction with the touch screen (such as displaying graphs or PowerPoint presentations).

⦿ **Attention:**

- Do *not* open the display with too much force, otherwise the panel or hinges may be damaged.

Note: The keyboard and touch pad are automatically locked when the screen is opened beyond 190 degrees (approximately).

Chapter 1. Getting to know your computer

■ ■ Left-side view

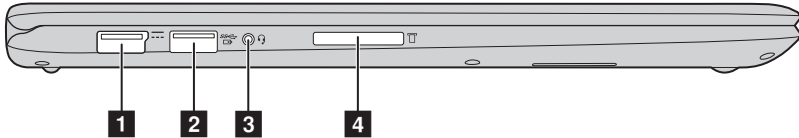

1 AC power adapter jack Connects to the AC power adapter.

2 USB 3.0 port Connects to USB devices.

Note: If the battery charge is more than 20%, the USB port with a  mark supports charging of an external USB device, even when the computer is turned off.

3 Combo audio jack Connects to headsets.

Notes:

- The combo audio jack does not support conventional microphones.
- The recording function may not be supported if third-party headphones or headsets are connected, due to different industry standards.

4 Memory card slot Insert memory cards (not supplied) here.

Note: For details, see “Using memory cards (not supplied)” on page 10.

■ Connecting USB devices

You can connect a USB device to your computer by inserting its USB plug (Type A) into the USB port on your computer.

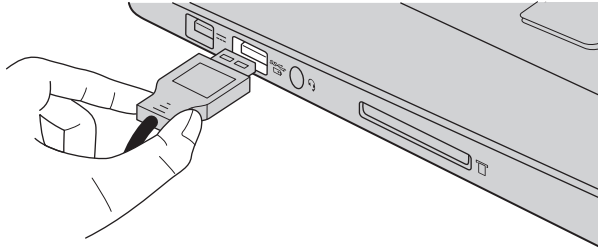

The first time you plug a USB device into a particular USB port on your computer, Windows automatically installs a driver for that device. After the driver has been installed, you can disconnect and reconnect the device without performing any additional steps.

Note: Typically, Windows detects a new device after it has been connected, and then installs the driver automatically. However, some devices may require you to install the driver before connecting. Check the documentation provided by the device's manufacturer before connecting the device.

Before disconnecting a USB storage device, make sure your computer has finished transferring data to that device. Click the **Safely Remove Hardware and Eject Media** icon in the Windows notification area to remove the device before disconnecting.

Note: If your USB device uses a power cord, connect the device to a power source before connecting it. Otherwise, the device may not be recognized.

Chapter 1. Getting to know your computer

■ Using memory cards (not supplied)

Your computer supports the following types of memory cards:

- Secure Digital (SD) card
- Secure Digital High Capacity (SDHC) card
- SD eXtended Capacity (SDXC) card
- MultiMediaCard (MMC)

Notes:

- Insert *only* one card in the slot at a time.
- This card reader does not support SDIO devices (e.g., SDIO Bluetooth, etc.).

Inserting a memory card

Insert the memory card until it touches the bottom of the slot.

Removing a memory card

Gently pull the memory card out of the memory card slot.

Note: Before removing the memory card, disable it by using the Windows safely remove hardware and eject media utility to avoid data corruption.

■ ■ Right-side view

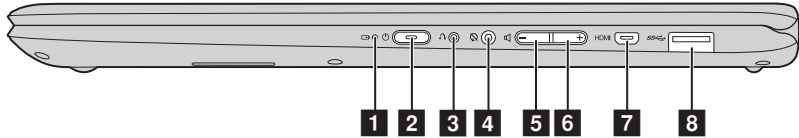

1 Battery status indicator

2 Power button and power status indicator Press this button to turn on the computer.

Indicator	Indicator status	Meaning
Battery status indicator	On (solid white)	The battery has more than 20% charge.
	Solid amber	The battery has between 5% and 20% charge.
	Fast blinking amber	The battery has less than 5% charge.
	Slow blinking amber	The battery is being charged. When battery charge reaches 20%, the blinking color changes to white.
	Slow blinking white	The battery has between 20% and 80% charge and is still charging. When the battery reaches 80% charge the light will stop blinking, but charging will continue until the battery is fully charged.
Power status indicator	On (solid white)	The computer is powered on.
	Blinking	The computer is in sleep mode.
	Off	The computer is powered off.

Chapter 1. Getting to know your computer

- 3 Novo button** When the computer is off, press this button to start the Lenovo OneKey Recovery system or the BIOS setup utility, or to enter the boot menu.
- 4 Rotation lock button** Keeps the screen locked in portrait or landscape orientation. Locking the screen rotation will disable the gravity sensing function, thereby preventing the screen from changing its orientation automatically depending upon the angle at which it is held.

Note: The screen rotation lock button will be disabled in notebook mode.

- 5 Volume down button** Decreases the volume level.
- 6 Volume up button** Increases the volume level.
- 7 Micro HDMI port** Connects to devices with micro HDMI input such as a TV or an external display.
- 8 USB 3.0 port** Connects to USB devices.

Note: For details, see “Connecting USB devices” on page 9.

■ Screen orientation

You can rotate the display panel to your preferred orientation.

- The orientation of the display automatically changes (alternating between portrait and landscape modes) depending upon how you hold the computer.

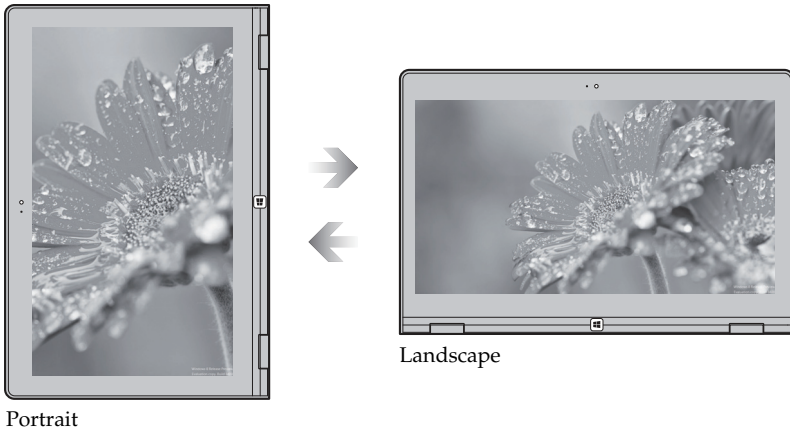

- To prevent automatic orientation, press the rotation lock button. It is located on the right edge of the computer (See illustration below).

Note: The screen rotation lock button will be disabled in notebook mode.

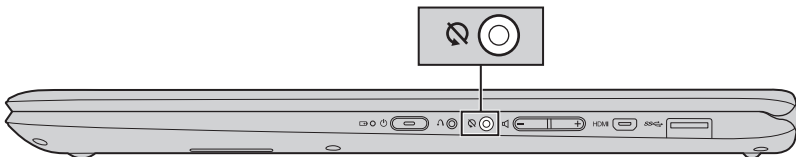

Chapter 1. Getting to know your computer

■ ■ Bottom view

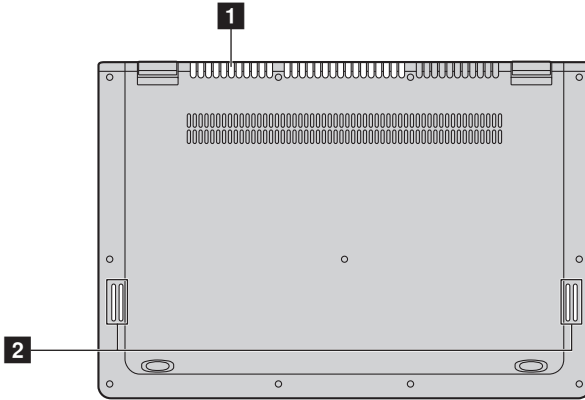

1 Ventilation slots Allow air to enter the computer for cooling.

2 Speakers Provide audio output.

Chapter 2. Starting to use Windows 8.1

■ ■ Configuring the operating system for the first time

You may need to configure the operating system when it is first used. The configuration process may include the procedures below:

- Accepting the end user license agreement
- Configuring the Internet connection
- Registering the operating system
- Creating a user account



■ ■ Operating system interfaces

Windows 8.1 comes with two main user interfaces: the Start screen and the Windows desktop.

To switch from the Start screen to the Windows desktop, do one of the following:

- Select the Windows desktop tile on the Start screen.
- Press the Windows button.
- Press the Windows key  + D.

To switch from the desktop to the Start screen, do one of the following:

- Select **Start**  from the charms bar.
- Press the Windows key .
- Move the cursor to the lower-left corner, and then select the Start button.

Start screen

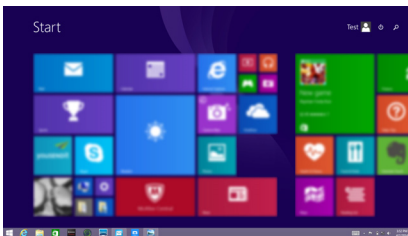

Desktop

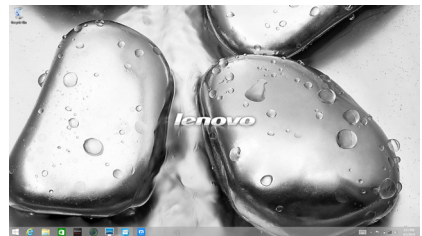

Chapter 2. Starting to use Windows 8.1

■ ■ The charms

Charms are navigation buttons that let you control your Windows® 8.1 experience. Charms include: Search, Share, Start, Devices, and Settings. The **charms bar** is the menu that contains the charms.

The five charms provide new and faster ways to perform many basic tasks, and are always available regardless of whichever app you are currently in.

To display the charms, do one of the following:

- Move the cursor to the upper-right or lower-right corner until the charms bar is displayed.
- Use one finger to swipe in from the right edge of the screen until the charms bar is displayed.
- Press the Windows key  + C.

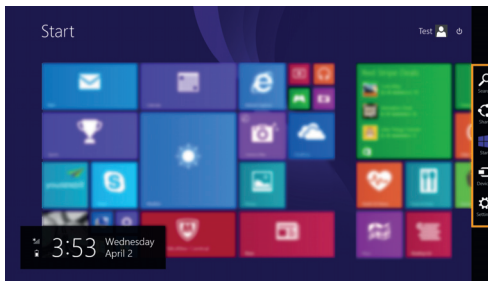

Search charm

The **Search** charm is a powerful new way to find what you are looking for, including settings, files, Web images, Web videos, etc.

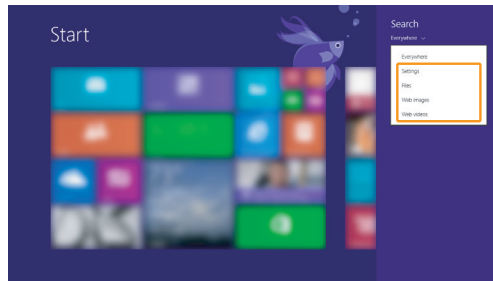

Share charm

The **Share** charm lets you send links, photos, and more to your friends and social networks without leaving the app you are in.

Start charm

The **Start** charm is a fast way to go to the Start screen.

Devices charm

The **Devices** charm allows you to connect or send files to any external devices, including the devices to play, print, and project.

Chapter 2. Starting to use Windows 8.1

Settings charm

The **Settings** charm lets you perform basic tasks, such as setting the volume or shutting down the computer. Also, you can get to the Control Panel through the **Settings** charm when on the Desktop screen.



■ ■ Putting the computer to sleep or shutting it down



When you have finished working with your computer, you can put it to sleep or shut it down.

■ Putting your computer to sleep

If you will be away from your computer for only a short time, put the computer to sleep.

When the computer is in sleep mode, you can quickly wake it to resume use, bypassing the startup process.

To put the computer to sleep, do one of the following:

- Close the display lid.
- Press the power button.
- Open the charms bar and then select **Settings**  → **Power**  → **Sleep**.

Note: Put your computer to sleep before you move it. Moving your computer while the hard disk drive is spinning can damage the hard disk, causing loss of data.

To wake the computer, do one of the following:

- Press any key on the keyboard. (Notebook mode only)
- Press the power button.
- Press the Windows button.

Chapter 2. Starting to use Windows 8.1

■ Shutting down the computer

If you are not going to use your computer for a long time, shut it down. To shut down your computer, do one of the following:

- Open the charms bar and then select **Settings**  → **Power**  → **Shut down**.

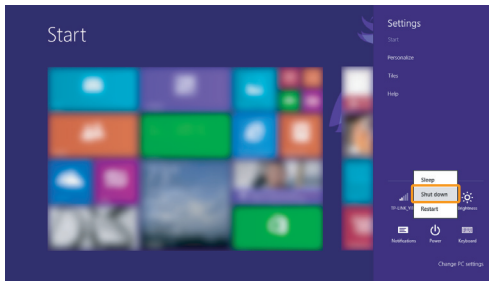
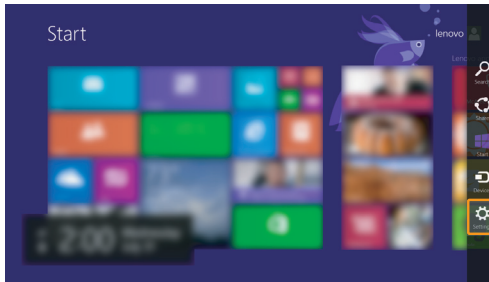

Chapter 2. Starting to use Windows 8.1

- Right-click the Start button in the lower-left corner and select **Shut down or sign out** → **Shut down**.

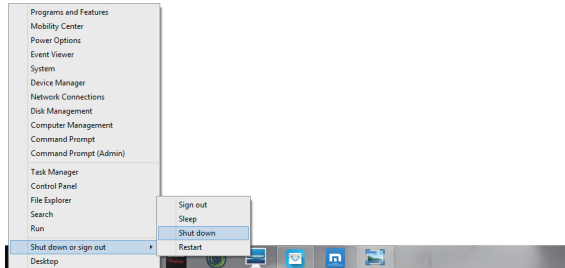

- On the Start screen, click  and select **Shut down**.

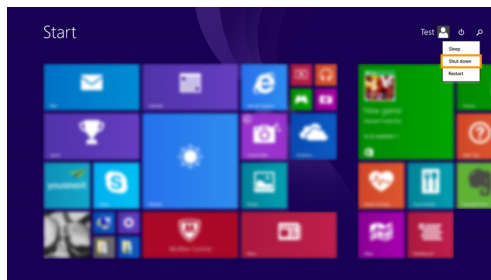

Note: This operation depends on your BIOS settings. Please refer to the actual product.



Chapter 2. Starting to use Windows 8.1

■ Touch screen operation

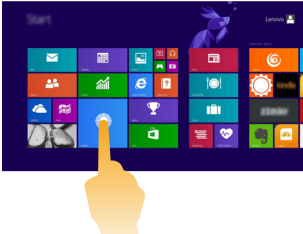

The display panel can accept inputs like a tablet, using the multi-touch screen, or like a traditional notebook computer, using the keyboard and touch pad.

■ Multi-touch gestures

You can touch the screen with one or more fingertips to perform a variety of tasks.

Frequently used gestures	Tasks performed
<p>Tap Tap once on an item.</p> 	<p>Performs an action, such as starting an app, opening a link, or performing a command. Similar to left-clicking with a mouse.</p>
<p>Press and hold Press your finger down and leave it there for a moment.</p> 	<p>Allows you to see detailed information before selecting an action. Can also open a menu with more options. Similar to right-clicking with a mouse.</p>

(continued)

Frequently used gestures	Tasks performed
<p>Zoom Move two fingers together or apart while touching the screen.</p> 	<p>Zooms in and out on visual apps, such as pictures and maps. Can also jump to the beginning or end of a list.</p>
<p>Rotate Place two or more fingers on an item and then turn your hand.</p> 	<p>Turns an object. (Note: Not all items can be rotated, depending upon the app.)</p>
<p>Slide Drag your finger across the screen.</p> 	<p>Pans or scrolls through lists and pages. Can also move an object or be used to draw or write, depending upon the app. Similar to pressing and holding to pan and to scrolling with a mouse.</p>

Chapter 2. Starting to use Windows 8.1

(continued)

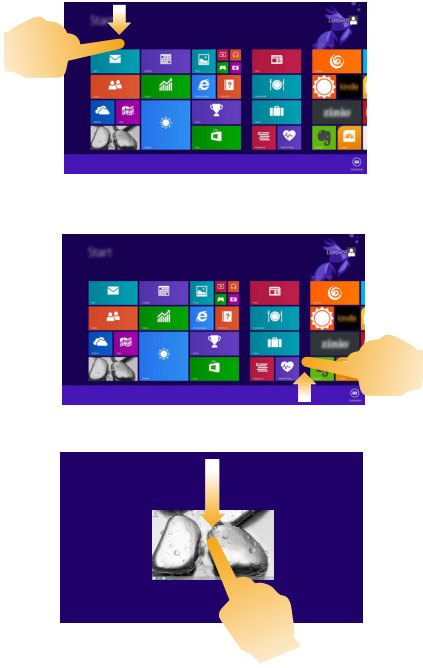
Frequently used gestures	Tasks performed
<p data-bbox="120 338 196 363">Swipe</p> <p data-bbox="120 367 532 422">Start from any edge of the screen, then swipe inwards toward the center.</p> 	<p data-bbox="596 338 991 481">Swiping down from the top edge or up from the bottom edge displays a task bar on the bottom of the screen with app commands, including New, Refresh, and other commands.</p> <p data-bbox="596 513 968 569">If you have an app currently open, you can also:</p> <ul data-bbox="596 582 991 933" style="list-style-type: none">• Swipe from the top edge to halfway down the screen without lifting your finger to dock that app on the left or right side of the screen. This allows you to keep two apps open simultaneously in a split-screen format.• Swipe from the top edge straight down to the bottom edge of the screen continuously without lifting your finger to close the currently open app.

(continued)

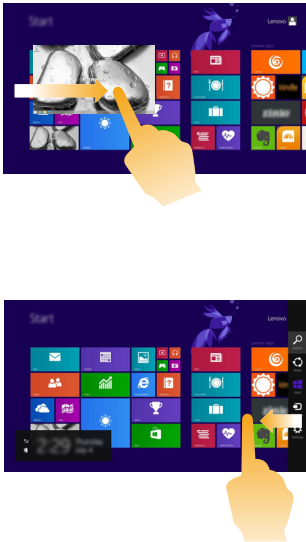

Frequently used gestures	Tasks performed
	<p>Swiping in from the left edge can:</p> <ul style="list-style-type: none">• Bring in and open an app currently running in the background. <p>If there is more than one currently open app, you can:</p> <ul style="list-style-type: none">• Swipe in from the left to bring in an app and, without lifting your finger, push that app quickly back off the left edge of the screen. This displays a list of the apps currently running in the background. <p>Swiping in from the right edge of the screen displays the charms.</p>

Chapter 2. Starting to use Windows 8.1

■ ■ Connecting to a wireless network

Enabling wireless connection

To enable wireless functions, do one of the following:

- Press  to disable airplane mode.
- Open the charms bar and select **Settings**  →  to open the network configuration page. Then toggle the airplane mode switch to **Off**.

Connecting to a wireless network

After wireless has been enabled, the computer will automatically scan for available wireless networks and display them in the wireless network list. To connect to a wireless network, click the network name in the list, and then click **Connect**.

Note: Some networks require a network security key or passphrase for connection. To connect to one of those networks, ask the network administrator or the Internet service provider (ISP) for the security key or passphrase.

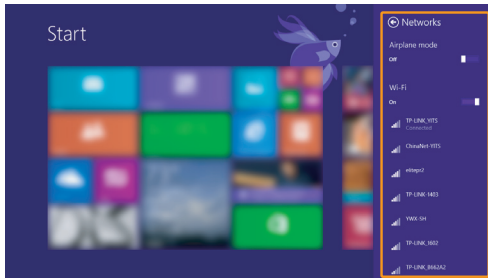

■ ■ Help and support

If you have a problem with the operating system, see the Windows Help and Support file. To open the Windows Help and Support file, do one of the following:

- Select **Settings** charm, then select **Help**.
- Press **Fn + 1** (depending on your keyboard layout)

You can read the Windows Help and Support file on your computer. You can also get online help and support by clicking on one of the two links listed under **More to explore**.

Note: Windows 8.1 also provides an app, **Help+Tips**. You can find it on the Start screen, to learn more information on new features of Windows 8.1.

Chapter 3. Lenovo OneKey Recovery system

The Lenovo OneKey Recovery system is software designed to back up and restore your computer. You can use it to restore the system partition to its original status in case of a system failure. You can also create user backups for easy restoration as required.

Notes:

- If your computer is preinstalled with a GNU/Linux operating system, OneKey Recovery system is not available.
- To utilize the features of the OneKey Recovery system, your hard disk already includes a hidden partition by default to store the system image file and the OneKey Recovery system program files. This default partition is hidden for security reasons, which explains why the available disk space is less than the stated capacity.

■ Backing up the system partition

You can back up the system partition to an image file. This image file can be used to restore the system partition. To back up the system partition:

- ❶ In Windows, press the Novo button or double-click OneKey Recovery icon to start the Lenovo OneKey Recovery system.
- ❷ Click **System Backup**.
- ❸ Select a back-up location and click **Next** to start the backup.

Notes:

- You can choose a back-up location on the local hard disk drive or an external storage device.
- Remove the removable hard disk drive before starting the Lenovo OneKey Recovery system. Otherwise, data from the removable hard disk drive might be lost.
- The back-up process may take a while.
- The back-up process is only available when Windows can be started normally.

■ Restoring

You can choose to restore the system partition to its original status or to a previously created back-up point. To restore the system partition:

- ① In Windows, press the Novo button or double-click OneKey Recovery icon to start the Lenovo OneKey Recovery system.
- ② Click **System Recovery**. The computer will restart to the recovery environment.
- ③ Follow the on-screen instructions to restore the system partition to its original status or to a previously created back-up point.

Notes:

- The recovery process is irreversible. Make sure to back up any data you wish to save on the system partition before starting the recovery process.
- The recovery process may take a while. So be sure to connect the AC power adapter to your computer during the recovery process.
- The above instructions should be followed when Windows can be started normally.

If Windows cannot be started, then follow the steps below to start the Lenovo OneKey Recovery system:

- ① Shut down the computer.
- ② Press the Novo button. From the **Novo Button Menu**, select **System recovery** and press Enter.

Chapter 4. Troubleshooting

■ ■ Frequently asked questions

This section lists frequently asked questions by category.

■ Finding information

What safety precautions should I follow when using my computer?

The *Lenovo Safety and General Information Guide* which came with your computer contains safety precautions for using your computer. Read and follow all the precautions when using your computer.

Where can I find the hardware specifications for my computer?

You can find hardware specification for your computer on the printed flyers which came with your computer.

Where can I find warranty information?

For the warranty applicable to your computer, including the warranty period and type of warranty service, see the Lenovo limited warranty flyer that came with your computer.

■ Drivers and preinstalled software

Where are the installation discs for Lenovo preinstalled software (desktop software)?

Your computer did not come with installation discs for Lenovo preinstalled software. If you need to reinstall any preinstalled software, you can find the installation program on the C partition of your hard disk. If you cannot find the installation program there, you can also download it from the Lenovo consumer support website.

Where can I find drivers for the various hardware devices of my computer?

If your computer is preinstalled with a Windows operating system, Lenovo provides drivers for all the hardware devices that you need on the C partition of your hard disk. You can also download the latest device drivers from the Lenovo consumer support website.

■ Lenovo OneKey Recovery system

Where are the recovery discs?

Your computer did not come with recovery discs. Use the Lenovo OneKey Recovery system if you need to restore the system to its factory status.

What can I do if the back-up process fails?

If you can start the backup but it fails during the back-up process, try the following steps:

- ❶ Close all open programs, and then restart the back-up process.
- ❷ Check to see if the destination media is damaged. Select another path and then try again.

When do I need to restore the system to its factory status?

Use this feature when the operating system fails to start up. If there is critical data on the system partition, back it up before starting recovery.

■ BIOS setup utility

What is the BIOS setup utility?

The BIOS setup utility is ROM-based software. It displays basic computer information and provides options for setting boot devices, security, hardware mode, and other preferences.

How can I start the BIOS setup utility?

To start the BIOS setup utility:

- ❶ Shut down the computer.
- ❷ Press the Novo button and then select **BIOS Setup**.

How can I change the boot mode?

There are two boot modes: **UEFI** and **Legacy Support**. To change the boot mode, start the BIOS setup utility and set boot mode to **UEFI** or **Legacy Support** on the boot menu.

Chapter 4. Troubleshooting

When do I need to change the boot mode?

The default boot mode for your computer is **UEFI** mode. If you need to install a legacy operating system, such as Windows, Linux or Dos, etc (that is, any operating system before Windows 8) on your computer, you must change the boot mode to **Legacy Support**. The legacy operating system, such as Windows, Linux or Dos, etc cannot be installed if you don't change the boot mode.

■ Getting help

How can I contact the customer support center?

See “Chapter 3. Getting help and service” in the *Lenovo Safety and General Information Guide*.

■ ■ Troubleshooting

Display problems

When I turn on the computer, nothing appears on the screen.

- If the screen is blank, make sure that:
 - The AC power adapter is connected to the computer, and the power cord is plugged into a working electrical outlet.
 - The computer power is on. Press the Power button again for confirmation.
- If these items are set correctly, and the screen remains blank, have the computer serviced.

When I turn on the computer, only a white cursor appears on a blank screen.

- Restore backed-up files to your Windows environment or the entire contents of your hard disk to its original factory contents using the Lenovo OneKey Recovery system. If you still see only the cursor on the screen, have the computer serviced.

The screen goes blank while the computer is on.

- Your power management is enabled. Do one of the following to resume from sleep mode:
 - Press any key on the keyboard. (Notebook mode only)
 - Press the Power button.
 - Press the Windows button.
 - Press **F9** () to confirm whether the backlight of the LCD screen has been turned off.

Sleep problems

The critical low-battery error message appears, and the computer immediately turns off.

- The battery power is getting low. Connect the AC power adapter to the computer.

The computer enters sleep mode immediately after Power-on.

- Make sure that:
 - The battery is charged.
 - The operating temperature is within the acceptable range. See “Chapter 2. Use and care Information” in the *Lenovo Safety and General Information Guide*.

Note: If the battery is charged and the temperature is within range, have the computer serviced.



Chapter 4. Troubleshooting

The computer does not return from sleep mode and the computer does not work.

- If your computer is in sleep mode, connect the AC power adapter to the computer, then press the Windows button or the Power button.
- If the system still does not return from sleep mode, your system has stopped responding, and you cannot turn off the computer; reset the computer. Unsaved data may be lost. To reset the computer, press and hold the Power button for eight seconds or more. If the computer still does not reset, remove the AC power adapter.

Display panel problems

The screen is blank.

- Do the following:
 - If you are using the AC power adapter or the battery, and the battery status indicator is on, press **F12** () to make the screen brighter.
 - If the power indicator is blinking, press the Power button to resume from sleep mode.
 - Press **F9** () to confirm whether the backlight of the LCD screen has been turned off.
 - If the problem persists, follow the solution in the next problem “The screen is unreadable or distorted.”

The screen is unreadable or distorted.

- Make sure that:
 - The screen resolution and color quality are correctly set.
 - The monitor type is correct.

Incorrect characters appear on the screen.

- Is the operating system or programs installed correctly? If they are installed and configured correctly, have the computer serviced.

Sound problems

No sound can be heard from the speakers even when the volume is turned up.

- Make sure that:
 - The Mute function is off.
 - The combo audio jack is not being used.
 - Speakers are selected as the playback device.

Battery problems

Your computer shuts down before the battery status indicator shows empty.

-or-

Your computer operates after the battery status indicator shows empty.

- Recharge the battery.

Other problems

Your computer does not respond.

- To turn off your computer, press and hold the Power button for eight seconds or more. If the computer still does not respond, remove the AC power adapter.
- Your computer might lock when it enters sleep mode during a communication operation. Disable the sleep timer when you are working on the network.

The connected external device does not work.

- Do *not* connect or disconnect any external device cables other than USB while the computer power is on. Otherwise, you might damage your computer.
- When using high power consumption external devices, such as an external USB optical disk drive, use an external device power adapter. Otherwise, the device may not be recognized, or the system may shut down as a result.

Trademarks

The following terms are trademarks or registered trademarks of Lenovo in the United States, other countries, or both.

Lenovo
OneKey

Microsoft and Windows are trademarks of Microsoft Corporation in the United States, other countries, or both.

Other company, products, or service names may be trademarks or service marks of others.

lenovo®

©Lenovo China 2014

en-US
Rev. AA00

FCC Compliance Statement

1. This device complies with Part 15 of the FCC Rules. Operation is subject to the following two conditions: (1) this device may not cause harmful interference, and (2) this device must accept any interference received, including interference that may cause undesired operation.

2. The users manual or instruction manual for an intentional or unintentional radiator shall caution the user that changes or modifications not expressly approved by the party responsible for compliance could void the user's authority to operate the equipment. In cases where the manual is provided only in a form other than paper, such as on a computer disk or over the Internet, the information required by this section may be included in the manual in that alternative form, provided the user can reasonably be expected to have the capability to access information in that form.

3. CAUTION: Changes or modifications not expressly approved by the party responsible for compliance could void the user's authority to operate the equipment.

4. NOTE: This equipment has been tested and found to comply with the limits for a Class B digital device, pursuant to Part 15 of the FCC Rules. These limits are designed to provide reasonable protection against harmful interference in a residential installation. This equipment generates, uses and can radiate radio frequency energy and, if not installed and used in accordance with the instructions, may cause harmful interference to radio communications. However, there is no guarantee that interference will not occur in a particular installation. If this equipment does cause harmful interference to radio or television reception, which can be determined by turning the equipment off and on, the user is encouraged to try to correct the interference by one or more of the following measures:
 - Reorient or relocate the receiving antenna.
 - Increase the separation between the equipment and receiver.
 - Connect the equipment into an outlet on a circuit different from that to which the receiver is connected.
 - Consult the dealer or an experienced radio/TV technician for help.

5. This device has been tested and meets the FCC RF exposure guidelines. The highest reported SAR values for body-worn accessory and simultaneous transmission conditions are 1.144W/kg(1g) and 1.441W/kg(1g).

6. WARNING!! Read this information before using your phone
In August 1986 the Federal Communications Commission (FCC) of the United States with its action in Report and Order FCC 96-326 adopted an updated safety standard for human exposure to radio frequency (RF) electromagnetic energy emitted by FCC regulated transmitters. Those guidelines are consistent with the safety standard previously set by both U.S. and international standards bodies. The design of this

phone complies with the FCC guidelines and these international standards. Use only the supplied or an approved antenna. Unauthorized antennas modifications, or attachments could impair call quality, damage the phone, or result in violation of FCC regulations. Do not use the phone with a damaged antenna. If a damaged antenna comes into contact with the skin, a minor burn may result. Please contact your local dealer for replacement antenna.

BODY-WORN OPERATION:

This device was tested for typical body-worn operations with the back of the phone kept 0cm from the body. To comply with FCC RF exposure requirements, a minimum separation distance of 0cm must be maintained between the user's body and the back of the phone, including the antenna, whether extended or retracted. Third-party belt-clips, holsters and similar accessories containing metallic components shall not be used. Body-worn accessories

that cannot maintain 0cm separation distance between the user's body and the back of the phone, and have not been tested for typical body-worn operations may not comply with FCC RF exposure limits and should be avoided.

7. For more information about RF exposure, please visit the FCC website at www.fcc.gov
Your wireless handheld portable telephone is a low power radio transmitter and receiver. When it is ON, it receives and also sends out radio frequency (RF) signals. In August, 1996, the Federal Communications Commissions (FCC) adopted RF exposure guidelines with safety levels for hand-held wireless phones. Those guidelines are consistent with the safety standards previously set by both U.S. and international standards bodies:

Those standards were based on comprehensive and periodic evaluations of the relevant scientific literature. For example, over 120 scientists, engineers, and physicians from universities, government health agencies, and industry reviewed the available body of research to develop the ANSI Standard (C95.1). Nevertheless, we recommend that you use a hands-free kit with your phone (such as an earpiece or headset) to avoid potential exposure to RF energy. The design of your phone complies with the FCC guidelines (and those standards).

Use only the supplied or an approved replacement antenna. Unauthorized antennas, modifications, or attachments could damage the phone and may violate FCC regulations.

Industry Canada(IC)

1. This device complies with Industry Canada licence-exempt RSS standard(s). Operation is subject to the following two conditions: (1) this device may not cause interference, and (2) this device must accept any interference, including interference that may cause undesired operation of the device.

2. Le présent appareil est conforme aux CNR d'Industrie Canada applicables aux appareils radio exempts de licence. L'exploitation est autorisée aux deux conditions suivantes : (1) l'appareil ne doit pas produire de brouillage, et (2) l'utilisateur de l'appareil doit accepter tout brouillage radioélectrique subi, même si le brouillage est susceptible d'en compromettre le fonctionnement.

3. This device has been tested for compliance with FCC RF Exposure (SAR) limits in typical flat configurations.

In order to comply with SAR limits established in the RSS-102 & ANSI C95.1 standards, it is recommended when using a Broadcom 802.11a/b/g/n/ac WLAN + Bluetooth 4.0 NGFF2230 Mini Card Combo module that the integrated antenna is positioned more than 0cm from your body or nearby persons during extended periods of operation. If the antenna is positioned less than 2.5cm from the user, it is recommended that the user limit the exposure time.