

CardBus

Enhanced Wireless Network Adapter

User's Guide

Version A1
August 2002

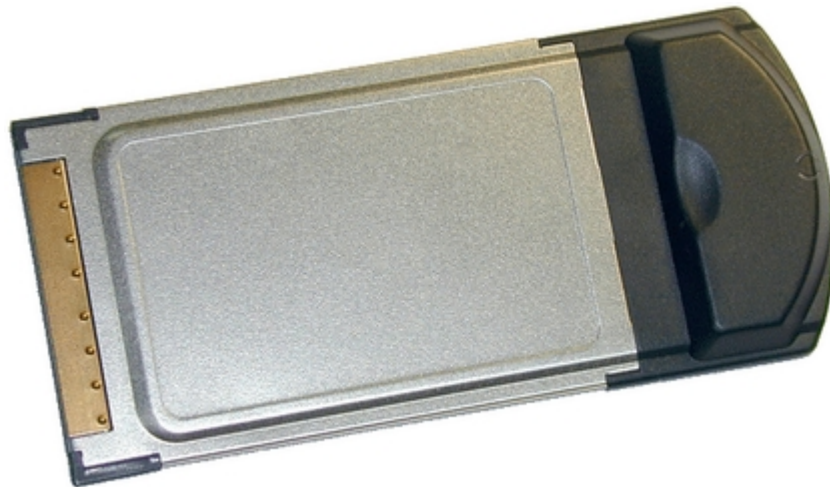

TRADEMARKS

All names mentioned in this document are trademarks or registered trademarks of their respective owners.

DISCLAIMER

This document is provided “as is,” without warranty of any kind, either expressed or implied, including, but not limited to, warranties of merchantability or fitness for a particular purpose. The manufacturer may release improved or modified versions of this manual or any product or program described in this manual at any time. This document could include technical inaccuracies or typographical errors.

FCC WARNING

This equipment has been tested and found to comply with the limits for a Class B Digital device pursuant to part 15 of the FCC Rules. These limits are designed to provide reasonable protection against harmful interference in a residential installation. This equipment generates, uses, and can radiate radio-frequency energy and, if not installed and used in accordance with the instructions, may cause harmful interference to radio communications. However, there is no guarantee that interference will not occur in a particular installation. If this equipment does cause harmful interference to radio or television reception, which can be determined by turning the equipment off and on, the user is encouraged to try to correct the interference by one or more of the following measures:

- Reorient or relocate the receiving antenna.
- Increase the separation between the equipment and the receiver.
- Connect the equipment to an outlet on a circuit different from that to which the receiver is connected.
- Consult the dealer or an experienced radio/TV technician for help.

You are cautioned that changes or modifications not expressly approved by the party responsible for compliance could void your authority to operate the equipment.

This device complies with part 15 of the FCC Rules. Operation is subject to the following two conditions:

- This device may not cause harmful interference, and
- This device must accept any interference received, including interference that may cause undesired operation.

This transmitter must not be co-located or operated in conjunction with any other antenna or transmitter.

Packing List

Your CardBus Enhanced Wireless Network Adapter package should contain the following items:

- One CardBus Enhanced Wireless Network Adapter
- One Wireless Adapter Driver disk
- One Wireless Adapter Utility disk
- One User's Guide disk

Quick Installation and Operation Guide

1. Exit all application programs and shut the computer down.

2. Insert the adapter in the CardBus slot.

See [chapter 3](#) of this user's guide for detailed instructions.

3. If the computer requires an external disk drive to access floppy disks, connect the drive.

4. Turn on the computer.

5. Install a driver from the Wireless Adapter Driver disk.

Follow the instructions on the screen and in [chapter 4](#) of this user's guide.

6. Remove the Wireless Adapter Driver disk and insert the Wireless Adapter Utility disk.

7. Install the Wireless Adapter Utility.

Open the **Start** menu, choose **Run**, type "a:\setup" (without quotation marks), press **Enter**, and follow the instructions on the screen and in [chapter 5](#) of this user's guide.

8. Create and apply a connection profile for a wireless network.

See [chapter 6](#) of this user's guide for detailed instructions.

Contents

	Introduction	1
1	System Requirements	2
1.1	Hardware	2
1.2	Software	2
2	Terminology Used in this Guide	3
3	Familiarization and Installation	5
3.1	The Parts of the Adapter	5
3.2	Adapter Installation	5
4	Driver Installation and Operation	7
4.1	Installation Preview	7
4.2	Installation Details	8
4.3	Controlling the Driver	10
4.4	Removing the Driver	11
5	Utility Installation, Startup, and Shutdown	12
5.1	Installation	12
5.2	Controlling the Utility	13
6	Operation	15
6.1	The Utility's Panels	15
6.1.1	The Information Panel	15
6.1.2	The Settings Panel	16
6.1.3	The About Panel	17
6.2	Connecting for the First Time	18
6.2.1	Required Information	18
6.2.2	Connection Steps	19
7	Utility Command Reference	22
7.1	Settings Panel	22
7.1.1	Site Survey Section	22
7.1.2	Connection Profiles Section	23
7.2	The Profile Editor	24
7.2.1	Profile Name	24
7.2.2	SSID	24
7.2.3	Transmission Rate	24
7.2.4	Network Mode	25
7.2.5	Channel	25
7.2.6	Power Saving Mode	25
7.2.7	Auth. Mode	26
7.2.8	Passphrase	26
7.2.9	Method	26

Appendixes

A	Character Conversion Charts	28
B	Troubleshooting	29
C	Technical Support	31
D	Limited Warranty	32
E	Specifications	34
F	Channels and Regulations	35

Figures

1. Ad-hoc network 3
2. Infrastructure network 3
3. Roamable multi-AP infrastructure network 4
4. CardBus Enhanced Wireless Network Adapter 5
5. Microsoft Windows 98 **Add New Hardware Wizard** window 7
6. Driver icon in system tray/notification area 10
7. Driver icon menus (1): main button 10
8. Driver icon menus (2): secondary button 11
9. Utility icons in the **Start** menu and on the desktop 13
10. Utility icon in the system tray/notification area 13
11. Closing the utility's main window 14
12. Shutting down the utility 14
13. Typical **Information** panel display on first startup 16
14. The **Settings** panel in a multi-network environment 17
15. The **About** panel 18
16. The **New Profile** dialog box 20
17. 64-bit WEP key input boxes and controls 21

Introduction

Congratulations on choosing an outstanding wireless networking product. Your CardBus Enhanced Wireless Network Adapter conforms to Institute of Electrical and Electronics Engineers (IEEE) standard 802.11b and the Wi-Fi specification of the Wireless Ethernet Compatibility Alliance (WECA). It supports data rates of up to 11 megabits per second (Mbps) and 40- and 128-bit Wired Equivalent Privacy (WEP) encryption, and will interoperate seamlessly with all other 802.11b and Wi-Fi compliant products.

Your adapter also supports Packet Binary Convolutional Code (PBCC) modulation and 256-bit encryption. It can therefore provide a higher data rate (22 Mbps), increased throughput, up to 30 percent greater range, and stronger security than other 802.11b-compliant adapters. These capabilities can be used on wireless links to products in the same family as your adapter.

This guide contains detailed instructions on installing and using your adapter and the software included with it. Basic terms and concepts of wireless networking are also introduced. Follow the instructions in this guide carefully to ensure that your CardBus Enhanced Wireless Network Adapter will give you many years of trouble-free, high-performance operation.

1 System Requirements

Before installing the adapter and related software, make sure the computer system meets the minimum requirements described below.

1.1 Hardware

The adapter can be installed in any recent-model IBM-type microcomputer with a CardBus slot, also known as a PCMCIA or PC Card slot. The adapter is a Type II CardBus card, and can be installed in a Type II or Type III CardBus slot.

The computer must have a 3.5-inch floppy-disk drive to allow installation of the driver and utility software for the adapter.

1.2 Software

The drivers included with the adapter allow the adapter to be used in Microsoft Windows 98, ME, 2000, and XP. Third-party drivers may allow the adapter to be used, with reduced functionality, in other operating systems.

2 Terminology Used in this Guide

Ad-hoc Network

An ad-hoc network is a wireless local-area network (WLAN) made up of stations communicating directly with each other through their wireless interfaces. There is no central relay point, and normally no connection to a wired network. Ad-hoc mode is sometimes referred to as *peer-to-peer*, *computer-to-computer*, or *Independent Basic Service Set (IBSS)* mode. Figure 1 shows a typical ad-hoc network.

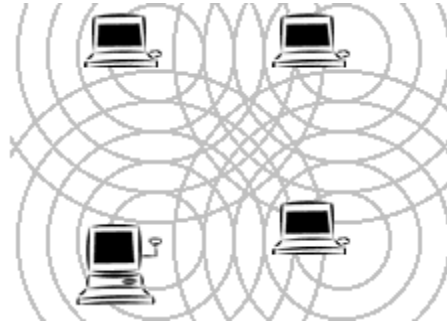

Figure 1. Ad-hoc network

Infrastructure Network

An infrastructure network is a WLAN made up of wireless stations and at least one wireless relay point, known as a *base station* or *access point (AP)*. The AP usually has a connection to a wired network, allowing wireless stations to use resources on that network. The AP also relays all communications between wireless stations in its coverage area; these stations never communicate directly with each other. Infrastructure mode is sometimes referred to as *managed* or *Basic Service Set (BSS)* mode. Figure 2 shows a typical infrastructure network.

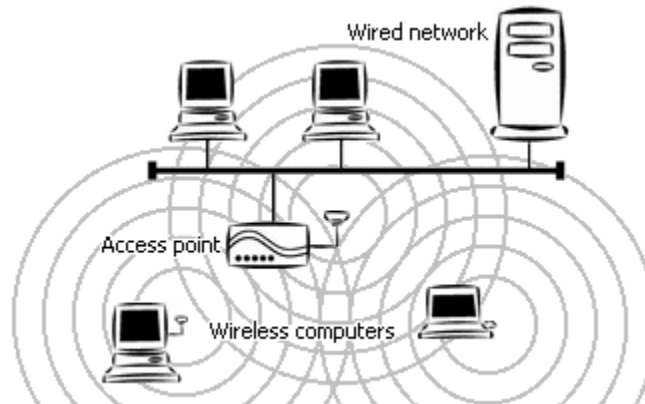

Figure 2. Infrastructure network

BSSID/MAC Address

A Basic Service Set (BSS) is two or more wireless devices that are in communication with each other. Like every wired Ethernet device, every wireless device has a fixed, unique “medium access control” (MAC) address. When wireless devices establish communication,

they automatically select the MAC address of one BSS member as an identifier for the group; this is the BSSID.

It has become customary to refer to a wireless device's MAC address as its BSSID even when the address is not being used to identify an active BSS.

A BSS that includes an access point is often referred to as a *cell*.

SSID/Domain Identifier

A Service Set Identifier (SSID) is a shared name, usually assigned by a network administrator, that identifies wireless devices that are allowed to communicate with each other. This is one way of providing basic security on a wireless network. An SSID can be up to 32 characters long, and can include letters and numbers.

Giving multiple access points the same SSID and encryption settings allows mobile stations that also share those settings to “roam” from one AP to another. When at least one AP is among the devices sharing an SSID, the name may be referred to as an *Extended Service Set Identifier* (ESSID).

An SSID is sometimes called a “domain name,” but it is unrelated to the domain names used to identify machines and networks on the Internet. Other terms for SSID are *domain ID*, *net ID*, *network name*, *extended network ID*, and *wireless network name*. The set of devices that an SSID identifies is sometimes called a *communication domain* or *wireless domain*.

Figure 3 shows a common wireless network setup. If the APs share SSID and encryption settings, mobile devices that also share those settings can roam among them.

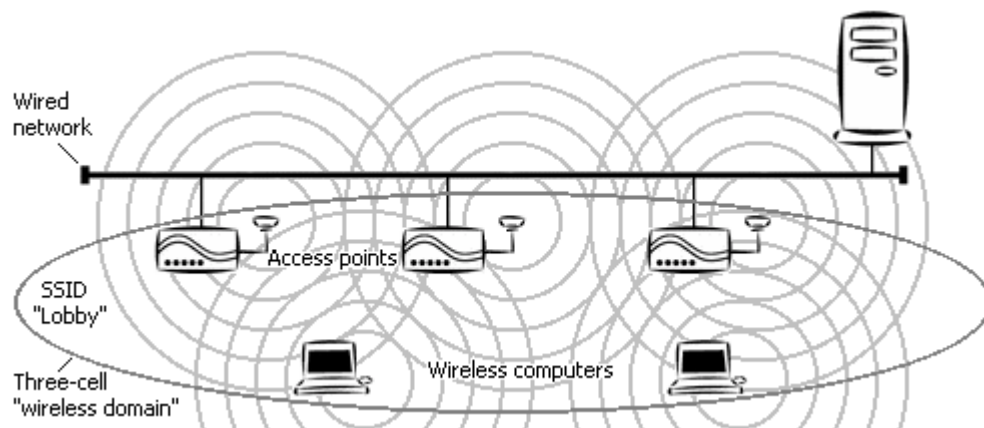

Figure 3. Roamable multi-AP infrastructure network

Roaming

When APs covering adjacent areas have the same SSID and encryption settings, a mobile device that also shares those settings can communicate through the APs continuously while moving from one coverage area to another. This is known as *roaming*. When one AP's signal begins to weaken, the mobile device automatically searches for another AP that it is authorized to “associate with” (that is, connect to); when the second AP's signal quality is better than that of the first, the station automatically switches over.

3 Familiarization and Installation

This chapter describes the adapter and gives instructions on inserting it for the first time.

3.1 The Parts of the Adapter

The adapter has a thin, rectangular end with 68 connector holes, and a thick, rounded end that contains the antenna and two light-emitting diode (LED) indicators.

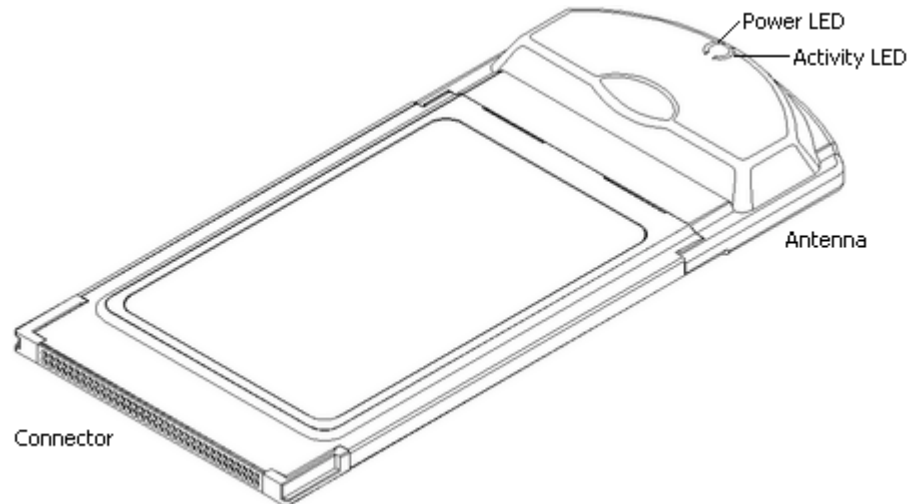

Figure 4. CardBus Enhanced Wireless Network Adapter

The connector end will fit only in a Type II or Type III CardBus slot (also called a “PCMCIA” or “PC Card” slot) that provides the correct voltage level for the adapter.

The antenna housing will extend outside the slot when the adapter is fully inserted. The LEDs indicate power and wireless network activity. When the antenna housing faces right like a capital letter D, the power LED is above the activity LED. The LEDs work as follows:

- The power LED shines green when the adapter is receiving power from the computer. Note that power to the adapter can be turned off and on through software.
- The activity LED shines orange when the adapter is transmitting or receiving.

3.2 Adapter Installation

On most computer systems, the adapter can be safely inserted or removed at any time. Certain cautions should, however, be noted:

- If the adapter is inserted or removed while the computer is running, the operating system may beep very loudly even if the sound control has been set to **Mute** or **Muted**.

- If the adapter will be connected to an extender card installed in a desktop computer, make sure the extender card is firmly bolted to the computer's housing before inserting or removing the adapter. Shifting or rocking of a loose extender card can result in momentary loss of contact, which can permanently damage sensitive electronic components.
- Microsoft Windows lets you turn off power to the adapter before removing it. Depending on your version of Windows, this may be called "stopping" or "disabling" the adapter. It is strongly recommended that you use this function and avoid removing the adapter while it is operating.

For installation of adapter software to go smoothly, follow the steps below when inserting the adapter for the first time.

1. Have the Wireless Adapter Driver disk, the Wireless Adapter Utility disk, and your Microsoft Windows CD-ROM ready.

The operating system might request the CD-ROM so it can install networking components. The CD-ROM's contents may have been copied to the hard disk during system installation; if you know the path to the copy on the hard disk, you will be able to supply that path instead of inserting the CD-ROM.

2. Exit all application and utility programs and shut down the computer.

3. If the computer uses an external floppy-disk drive, connect the drive as described in the manual for the computer.

4. With the computer turned off, insert the adapter in the CardBus slot.

The location of the CardBus slot depends on the make and model of the computer. See your computer manual for details. The manual might refer to the slot as a PCMCIA or PC Card slot.

Most CardBus slots have a button for removing adapters. The button is normally flush with the housing of the computer. Press and release it to make it extend outside the housing; press it again to eject an adapter from the slot. A third press will return it to its original position.

4 Driver Installation and Operation

After physically installing the adapter in the computer as described above, you are ready to install a driver. This is software that lets the adapter be used in a specific operating system. The Wireless Adapter Driver disk included with your adapter contains drivers for Microsoft Windows 98, ME, 2000, and XP.

The following note is for technicians experienced at installing drivers in Microsoft Windows. Other readers should go directly to [section 4.1, “Installation Preview,”](#) immediately following the note.

Note to technicians: The files on the driver disk reside in directories named according the version of Windows the files are for: \WIN2K, \WIN98, and \WINXP. For Windows ME, use the files in \WIN98. Although Windows XP has a built-in driver for the adapter, the supplied utility program will work only if the supplied driver is installed and activated.

4.1 Installation Preview

When Microsoft Windows detects a newly installed adapter, it starts up a special program to help you install a driver. Below is the opening window of the program that runs in Windows 98:

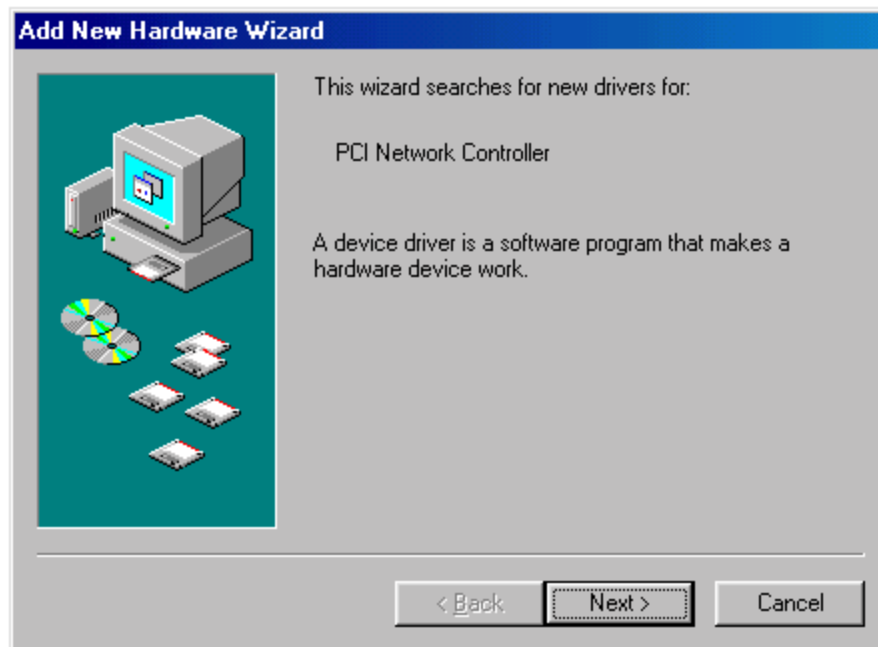

Figure 5. Microsoft Windows 98 Add New Hardware Wizard window

Each version of Windows has a different “wizard” for installing new drivers. To explain and illustrate all the steps required in each version would fill up this entire manual. The following tips apply to all supported versions of Windows; keep them firmly in mind, and you will have no trouble installing the driver:

- You will be able to move forward and back through the installation process by choosing the **Next** and **Back** buttons at the bottom of the window.
- A number of options will appear during the installation process. You must select the options that tell the program:
 - You wish it to search for a driver.

If you do not tell it to search for a driver, it will display a list that you will have to search through yourself. This list will be long and hard to understand, and it might not contain the correct driver.
 - You will specify the location (or one of the locations) to search.

The program normally will not search on “removable media” such as a floppy disk. You must tell it in advance that you wish it to do so.
 - The location to search is a folder on the floppy disk in drive A.

The Wireless Adapter Driver disk contains three folders. When the program displays a text input box for specifying a location, type in the name of the folder that corresponds to your version of Windows. Type a:\win2k if you are using Windows 2000. Type a:\win98 if you are using Windows 98 or Windows ME. Type a:\winxp if you are using Windows XP.
- Always read everything in the window carefully, and make sure the correct options are selected, before choosing **Next**.
- Avoid common mistakes. Be sure to —
 - Insert the disk at a suitable time (either when the program window appears, or when you type a folder name into the location box).
 - Insert the Wireless Adapter Driver disk (and not the Wireless Adapter Utility disk).
 - Type a backslash [\] after “a:” when specifying the location of the driver (do not type a slash [/]).

For step-by-step instructions, see the appropriate part of the next section.

4.2 Installation Details

Microsoft Windows 98:

1. Turn on the computer. Windows 98 will detect the adapter and start the Add New Hardware Wizard.
2. Choose **Next**.
3. Select “Search for the best driver for your device” and choose **Next**.

4. Check “Floppy disk drives” and “Specify a location,” and uncheck all other options; then type the following into the location box: a:\win98
5. Insert the Wireless Adapter Driver disk in drive A and choose **Next**. The Add New Hardware Wizard will find the driver and show information about it.
6. Choose **Next**. Installation will begin.
7. Follow the on-screen instructions to finish.

Microsoft Windows ME (uses the Windows 98 driver):

1. Turn on the computer. Windows ME will detect the adapter and start the Add New Hardware Wizard.
2. Select “Specify the location of the driver (Advanced)” and choose **Next**.
3. Make sure “Search for the best driver for your device (Recommended)” is selected; under it, check both “Removable Media (Floppy, CD-ROM....)” and “Specify a location”; then type the following into the location box: a:\win98
4. Insert the Wireless Adapter Driver disk in drive A and choose **Next**. The Add New Hardware Wizard will find the driver and show information about it.
5. Choose **Next**. Installation will begin.
6. Follow the on-screen instructions to finish.

Microsoft Windows 2000:

1. Turn on the computer. Windows 2000 will detect the adapter and start the Found New Hardware Wizard.
2. Choose **Next**.
3. Select “Search for a suitable driver for my device” and choose **Next**.
4. Select “Specify a location” and choose **Next**.
5. Insert the Wireless Adapter Driver disk in drive A and type the following into the location box: a:\win2k
6. Choose **Next**. The Found New Hardware Wizard will find the driver and display information about it.
7. Choose **Next**; then choose **Yes**. Installation will begin.
8. When the Found New Hardware Wizard indicates that installation is complete, choose **Finish**.

Microsoft Windows XP:

1. Turn on the computer. Windows XP will detect the adapter and start the Found New Hardware Wizard.
2. Insert the Wireless Adapter Driver disk and select “Install from a list or specific location (Advanced)”; then choose **Next**.
3. Check “Include this location in the search” and type the following into the location box:
a:\winxp
4. Choose **Next**. Installation will begin.
5. When the Found New Hardware Wizard indicates that installation is complete, choose **Finish**.

After the driver is installed, an icon of a CardBus adapter will appear in the “system tray” or “notification area” of the task bar. The following illustration is from Microsoft Windows 98; the corresponding portion of your screen may look quite different:



Figure 6. Driver icon in system tray/notification area

4.3 Controlling the Driver

The driver normally works automatically:

- When the computer is turned on with the adapter inserted, the driver is loaded and its icon appears in the “system tray” (also called the “notification area”).
- When the computer is turned on with the adapter removed, the driver is not loaded and its icon does not appear.

You can also control the driver and the adapter as follows:

- **To deactivate the driver:** Click the driver’s icon using the mouse’s main button (usually the left button) and choose **Stop TI ACX100 WLAN Adapter**.

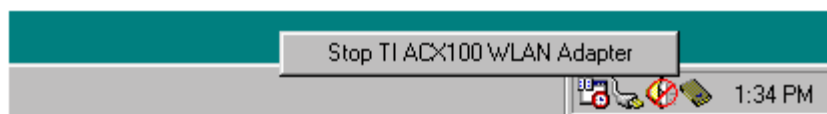

Figure 7. Driver icon menus (1): main button

This will unload the driver from the computer’s memory and turn off power to the adapter. The message “You may safely remove this device” will appear; choose **OK** to continue.

- **To reactivate the driver:** Open the **Start** menu, go to **Settings**, choose **Control Panel**, open the **Add New Hardware** (or **Add Hardware**) icon, choose **Next**, choose **Next** again, and press **Esc**.

Assuming the adapter is in the slot, the driver will be activated and the adapter will start working. Note that the system may stop responding to keyboard and mouse actions for about one minute.

- **To hide the driver's icon without deactivating the driver:** Click the icon using the mouse's secondary button (usually the right button) and choose **Disable PC Card Tray Icon**.

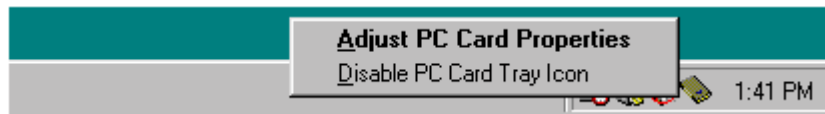

Figure 8. Driver icon menus (2): secondary button

- **To unhide the driver's icon:** Open the **Start** menu, go to **Settings**, choose **Control Panel**, open the **PC Card (PCMCIA)** icon, select the adapter, check the “Show control on taskbar” box, and choose **OK**.

The dialog box that appears when you open the **PC Card (PCMCIA)** icon contains adapter-related functions provided by the operating system. Some are self-explanatory; others are highly technical. There are two other ways to open this dialog box:

- double-click the driver's icon, or
- click the icon with the mouse's secondary button (usually the right button) and choose **Adjust PC Card Properties**.

If you wish to remove the adapter while the computer is running, it is strongly recommended that you first deactivate the driver as described above.

4.4 Removing the Driver

If you wish to remove the driver from the system, do so as described below. It is assumed here that the adapter has already been removed.

1. Open the **Start** menu, go to **Settings**, choose **Control Panel**, and open the **Network** icon.
2. In the list of network components, select **TI ACX100 WLAN Adapter**.
3. Choose **Remove**.

You will be asked for confirmation and instructed to reboot the computer.

5 Utility Installation, Startup, and Shutdown

To join and leave wireless networks and use the adapter's special features, you must install the utility included with the adapter. In addition to its basic functions, this utility has special features that make wireless networking as convenient as possible.

5.1 Installation

Before installing the utility, make sure all items on the following checklist have been completed:

- The adapter is installed and its LEDs light up.
- The driver is installed and its icon appears in the system tray (also known as the notification area).
- If the computer has no built-in floppy-disk drive, an external drive is connected.

Install the utility as follows:

1. Exit all application and utility programs.
2. Insert the Wireless Adapter Utility disk in the floppy-disk drive.
3. Open the **Start** menu, choose **Run**, and type the following into the input box labeled **Open**: a:setup
4. Press the **Enter** key (or choose **OK**).
5. Follow the instructions on the screen.

The installation program ordinarily places the Wireless Adapter Utility in the following location on your hard disk:

C:\Program Files\Wireless\Wireless Adapter Utility

It also normally adds a folder icon to the **Start** menu's **Programs** submenu labeled **Wireless Adapter Utility**. Commands to start and uninstall the Wireless Adapter Utility will appear when you choose this folder icon.

You will be given a chance to specify other locations for the utility on your hard disk and in the **Start** menu. After you have indicated your choices, the utility will be installed and a dialog box titled **Setup Complete** will appear.

6. Choose **Finish**.

Icons for the Wireless Adapter Utility will appear on your desktop and in the **Start** menu. The following example is from a computer running Microsoft Windows 98; the appearance of these items on your screen might be different.

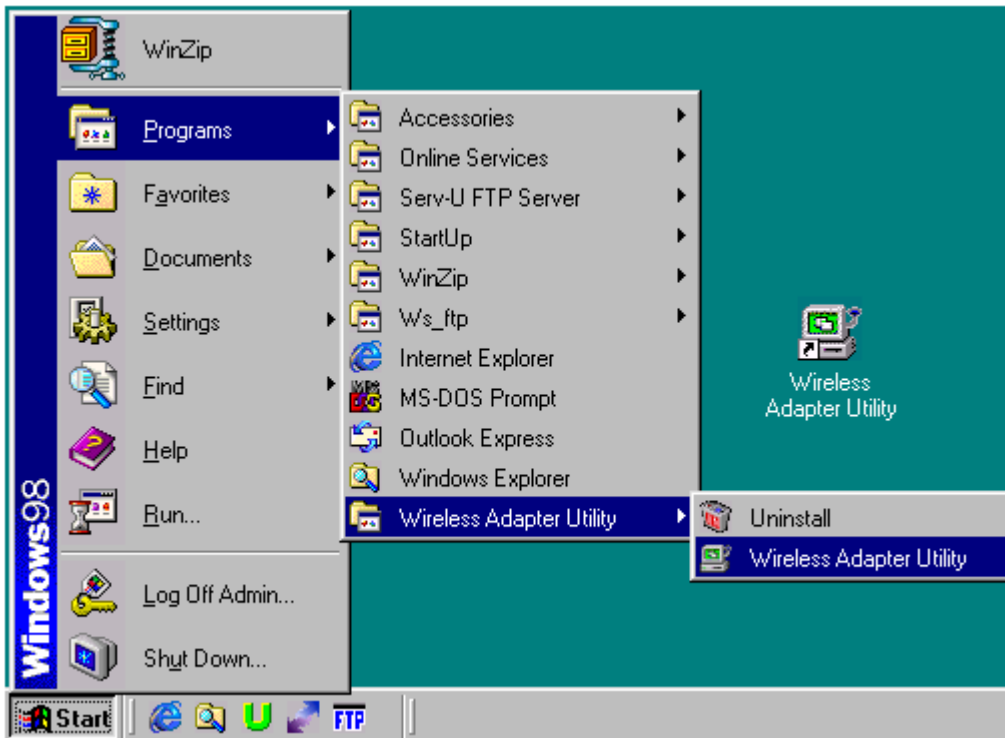

Figure 9. Utility icons in the Start menu and on the desktop

5.2 Controlling the Utility

The Wireless Adapter Utility behaves slightly differently from most programs with icons on the desktop and in the **Start** menu. Take note of the following so you will know what to expect when you start using the utility:

- You can start the utility up in either of two ways:
 - by opening the **Start** menu, going to **Programs**, choosing the **Wireless Adapter Utility** folder, and choosing the **Wireless Adapter Utility** command, or
 - by choosing the **Wireless Adapter Utility** icon on the desktop.
- When the utility is running, its icon appears in the system tray (also known as the notification area).

This icon has three states: (1) A green screen and radio waves show that you are connected to a wireless network. (2) A red screen and absence of radio waves show that the adapter and driver are working, but a wireless connection cannot be established. (3) A red **X** covering the icon shows that the driver is not running.



Figure 10. Utility icon in the system tray/notification area

- When you close the utility's main window in any of the usual ways (clicking its close box, choosing **Close** from its system menu, or pressing **Alt+F4**), the utility continues to run in the background.

The utility must be running to keep any wireless connections active.

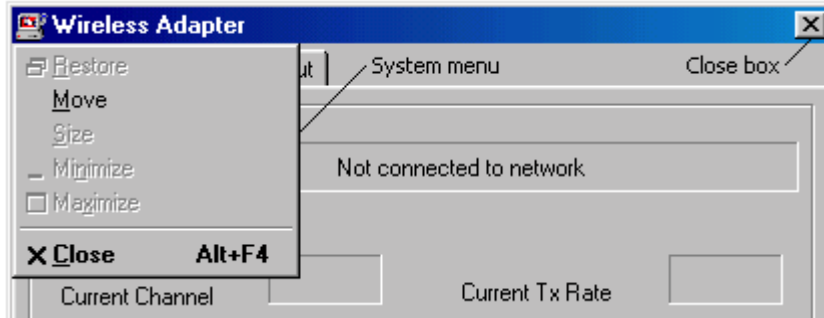

Figure 11. Closing the utility's main window

- To re-open the utility window, you can double-click the utility icon in the system tray, or you can carry out either of the procedures for starting the utility up (see [first item above](#)). None of these actions will cause multiple instances of the utility to run at the same time.
- To shut the utility down, click the utility's icon in the system tray with the mouse's secondary button (usually the right button) and choose the **Exit** command.



Figure 12. Shutting down the utility

Note that shutting down the utility will also shut down any existing wireless connections.

6 Operation

This chapter explains how to establish wireless connections using your CardBus Enhanced Wireless Network Adapter and the Wireless Adapter Utility. It is assumed here that —

- you have completed installation of the adapter, driver, and utility;
- you know how to start the utility, close and redisplay its window, and shut it down (see [section 5.2, “Controlling the Utility”](#)); and
- you are within range of at least one wireless device that is working and will accept a connection from you.

Any wireless connection, even a connection to a single device, is treated in this chapter as a connection to a wireless network. There is, in fact, no difference in the steps required to connect wirelessly to a single device or a whole network, and a connection to a single device is in fact a true network connection.

6.1 The Utility’s Panels

The utility has three panels: **Information**, **Settings**, and **About**. Illustrations and brief explanations of these panels are given below.

6.1.1 The Information Panel

The **Information** panel shows information about any active wireless link and the settings of four important wireless networking controls. The figure below shows the usual appearance of this panel the first time you start the utility up.

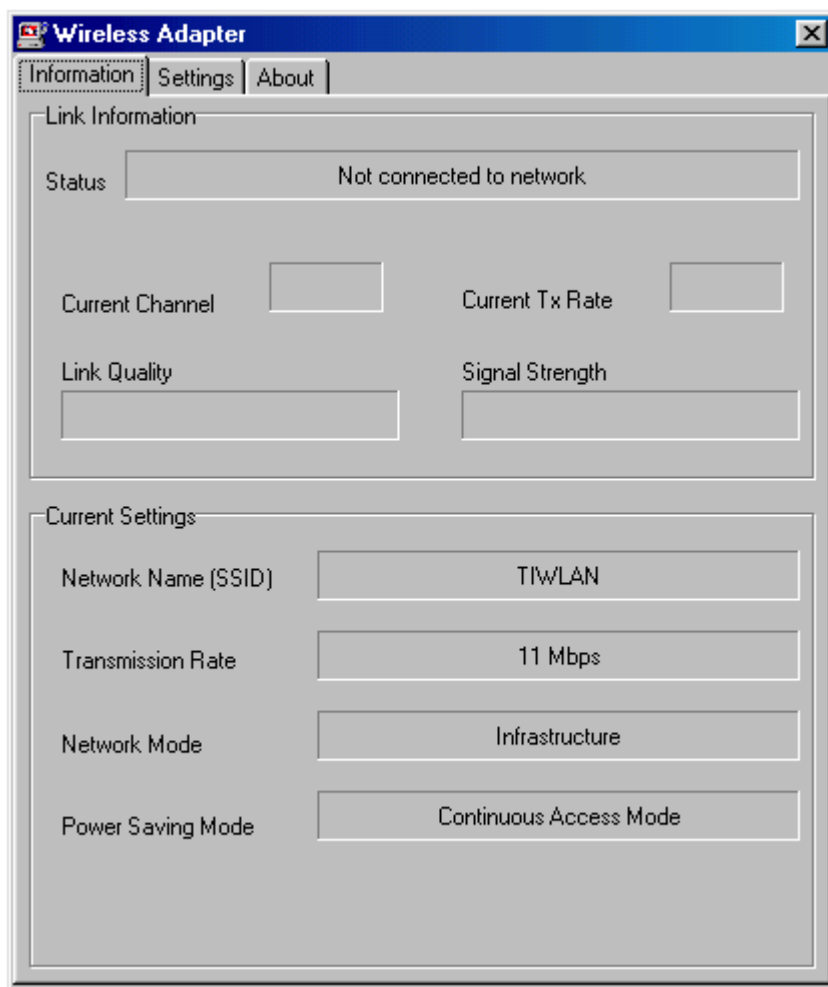

Figure 13. Typical Information panel display on first startup

Note the default setting shown in the **Network Name (SSID)** box. If the adapter had been within range of an access point (AP) that used the same SSID and did not require encryption, a connection would have been automatically established. This panel then would have shown the AP's SSID and BSSID, as well as the current channel, transmission rate, link quality, and signal strength.

(The terms *SSID*, *BSSID*, and *infrastructure* are explained in [chapter 2, "Terminology Used in this Guide,"](#) and in [section 7.1.1, "Site Survey Section."](#) Channels and transmission rates are also explained in section 7.1.1. *Mbps* stands for megabits per second.)

6.1.2 The Settings Panel

Choosing the **Settings** tab displays the **Settings** panel. This panel has a **Site Survey** section and a **Connection Profiles** section.

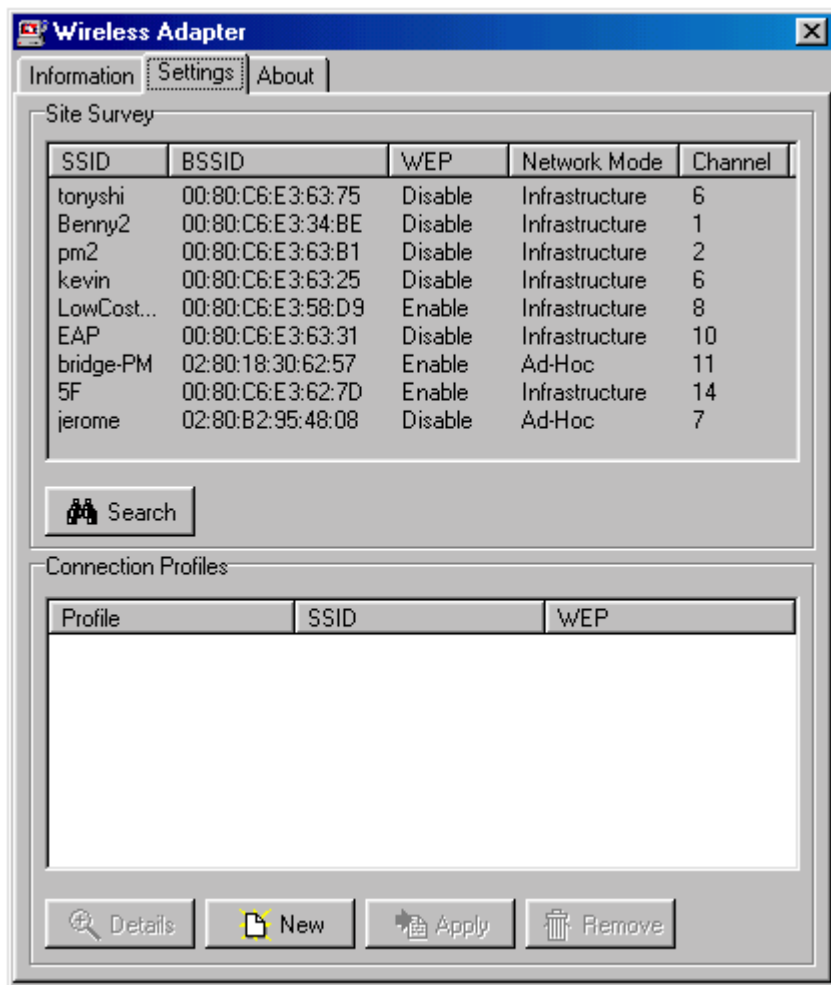

Figure 14. The Settings panel in a multi-network environment

The **Site Survey** section shows all wireless networks and devices that the adapter is currently receiving signals from. This information is updated each time the **Settings** panel is opened; you can also update it by choosing the **Search** button.

A “connection profile” is a group of settings that allows you to join a particular wireless network. You can create, save, edit, and remove profiles for as many wireless networks as you need to connect to; then, when you are within range of any one of them, all you have to do to join the network is “apply” the profile for it.

Basic profile management is explained in [section 6.2, “Connecting for the First Time.”](#)

6.1.3 The About Panel

The **About** panel contains copyright, platform, and version information. The version numbers of the utility, the driver, and the adapter’s firmware are all displayed.

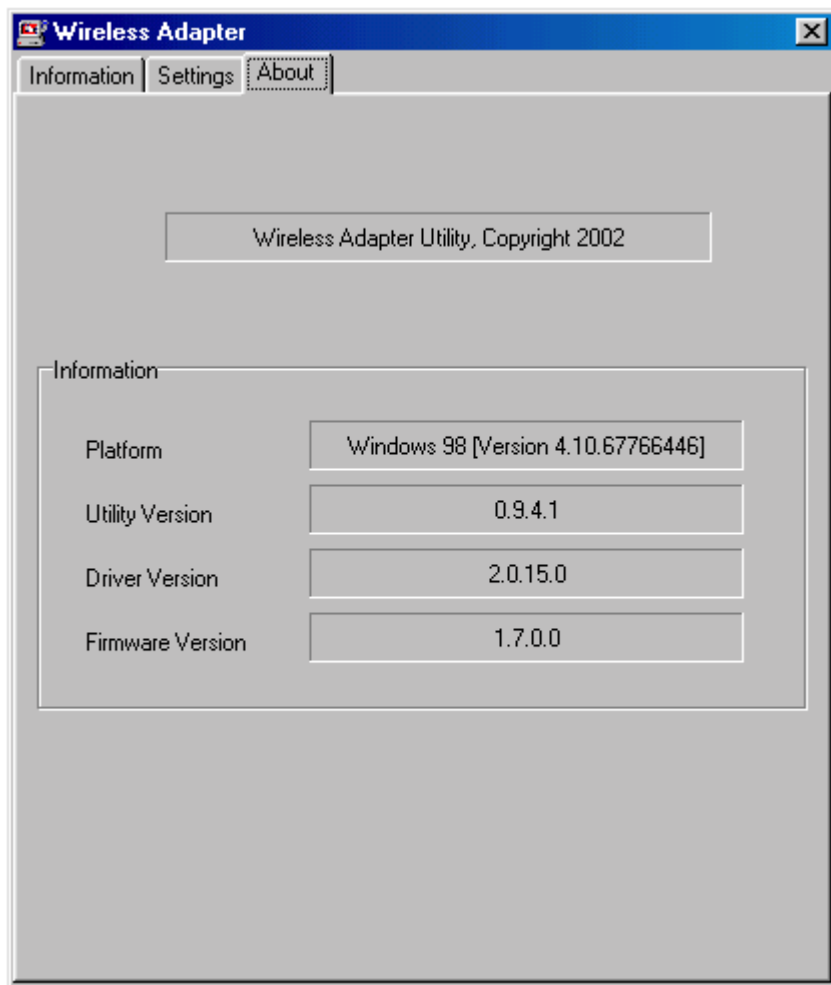

Figure 15. The About panel

6.2 Connecting for the First Time

A connection to a wireless network is made by creating, saving, and applying a profile for that network. This is done through the Wireless Adapter Utility's **Settings** panel.

6.2.1 Required Information

Before you create a connection profile, you need to know certain information about the wireless network that the profile is for:

- The **SSID**, sometimes referred to as the network name or ID, or the domain name or ID. If you are within range of the network, you can obtain the SSID from the **Settings** panel's **Site Survey** section. If it exceeds the width of the **SSID** column, place the pointer on it (or drag the **BSSID** column to the right) to see all of it.

Note: On some infrastructure networks where unusually tight security is enforced, SSID broadcasts (also known as “beacons”) are disabled. Such a network will not appear in the **Site Survey** listing, and you may not be able to connect to it even if you know the SSID.

- The **operating mode** of the network. This can be 802.11 ad-hoc, infrastructure, or high-speed ad-hoc. The **Site Survey** display will show you if a network is in ad-hoc or infrastructure mode.
 - If the mode is ad hoc (either 802.11 or high-speed), you will need to know the radio frequency channel the network is operating on. This is displayed in the **Site Survey** listing.
 - High-speed ad-hoc mode can be used only with wireless devices from the same product family as your adapter. The network installer or operator can tell you if the network is in high-speed ad-hoc mode.
- The **Wired Equivalent Privacy (WEP)** settings that are used on the network. WEP increases network security by encrypting transmissions on the basis of a “key” known only to authorized users. The **Site Survey** section will show you if WEP is enabled or disabled; if it is enabled, the network installer or operator can tell you the type and content of the key.
 - A key can be 64, 128, or 256 bits long. (A 64-bit key is sometimes called a “40-bit” key.) 256-bit keys can be used only with wireless devices from the same product family as your adapter.
 - A key may be given to you in the form of a text string, a series of numeric values in “hex” (hexadecimal, that is, base 16) notation, or a “passphrase.”
 - A text string must be converted to hex notation and typed in value by value. [Appendix A](#) contains conversion charts to help you do this.
 - In hex notation, the characters 0 through 9 and A through F are all considered digits. The letters represent the values we usually write as 10 through 15. (BSSIDs are always shown in hex.) When typing a value into a hex input box, you must type two hex digits.
 - A passphrase is a text string from which the utility will generate a key or keys. For this method to work, the device or devices you connect to must be from the same manufacturer as your adapter.

SSID, network mode (and possibly radio channel), and WEP settings (possibly including key length and content or generation method) — that is all you need to know to connect to any IEEE 802.11b-compliant wireless network.

The utility lets you adjust other settings that can conserve battery power and improve link performance. These are explained in [chapter 7, “Utility Command Reference.”](#) For now we will concentrate on getting connected.

6.2.2 Connection Steps

It is assumed here that you are within range of a wireless network that you are authorized to join. Join it as follows:

1. Start the Wireless Adapter Utility and open the **Settings** panel.

2. Find out the network's SSID, WEP, mode, and channel settings from the **Site Survey** results.

If the network does not appear immediately in the **Site Survey** listing, choose **Search** and wait a few seconds.

If the mode is ad-hoc, note the channel setting. If WEP is enabled, obtain detailed WEP settings from the network installer or operator.

3. In the **Connection Profiles** section, choose **New**.

The **New Profile** dialog box will appear.

The image shows a 'New Profile' dialog box with the following fields and controls:

- Properties:**
 - Profile Name: [Text Input]
 - SSID: [Text Input]
 - Transmission Rate: [Auto] (Dropdown)
 - Network Mode: [Infrastructure] (Dropdown)
 - Channel: [11] (Dropdown)
 - Power Saving Mode: [Continuous Access Mode] (Dropdown)
- Encryption:**
 - Auth. Mode: [Auto Switch] (Dropdown)
 - Passphrase: [Text Input] [Generate]
 - Method: [Disable] (Dropdown)
- Buttons:** [OK] [Cancel]

Figure 16. The New Profile dialog box

4. Decide on a name for the profile and type it in.

The name can be any length. It must not contain spaces.

5. Go to the **SSID** control (by clicking it or pressing **Tab**) and type in the SSID.

If the network is in infrastructure mode and WEP is enabled, skip the next two steps and go directly to step 8.

If the network is in infrastructure mode and WEP is disabled, skip the next three steps and go directly to step 9.

6. For an ad-hoc network, adjust the **Network Mode** control.

The default setting of this control is **Infrastructure**. Open the list and select **802.11 Ad-hoc** or **High-speed Ad-hoc**. (Use high-speed ad-hoc mode only for links to devices from the same product family as your adapter.)

7. For an ad-hoc network, check the setting of the **Channel** control.

The default setting is **11**. If the network uses another channel, open the list and select the correct setting.

8. For a network on which WEP is enabled, provide WEP settings.

Open the **Method** control and select the correct key length (64, 128, or 256 bits; select **64 bits** if the length you were told to use is 40 bits). Boxes for typing in a key or keys will appear.



Figure 17. 64-bit WEP key input boxes and controls

Create a key or keys by the hex input or passphrase method. If you have been given a textual key that is not a passphrase, consult [appendix A](#) and type the values corresponding to the characters of the key into the key input boxes. If you have been given a passphrase, type it into the **Passphrase** input box and choose **Generate**.

64-bit WEP encryption lets you create four keys and switch among them. The “default key” is the key currently in use on the network. Make sure the **Default Key** control, if it appears, is set to the right key.

9. Choose **OK**.

You will be returned to the **Settings** panel. The name of the new profile, the SSID of the network it is for, and WEP status will appear in the **Connection Profiles** section.

10. Select the new profile and choose **Apply**.

Instead of clicking the profile and then clicking **Apply**, you can double-click the profile.

You will be asked for confirmation. Choose **Yes** and you will be connected.

7 Utility Command Reference

This chapter explains all the controls in the Wireless Adapter Utility's **Settings** panel and profile editor. (The profile editor is the dialog box that appears when you choose **New** or **Details** in the **Connection Profiles** section of the **Settings** panel. It is illustrated in [figure 16](#).)

7.1 Settings Panel

The **Settings** panel displays information about any wireless networks you are within range of, and any connection profiles you have created. It contains a **Site Survey** section and a **Connection Profiles** section.

7.1.1 Site Survey Section

The **Site Survey** section shows the following information about any wireless networks you are within range of:

SSID

The SSID is a name, usually assigned by the network installer or operator, that is shared by all members of the network. To join any wireless network, you must set your machine to use that network's SSID.

BSSID

The BSSID is an automatically assigned numeric identifier for the network. On an infrastructure network, it is usually the medium access control (MAC) address of the access point (AP); on an ad-hoc network, it is usually the MAC address of one of the members. BSSIDs are shown in hexadecimal (base 16) notation.

WEP

WEP stands for Wired Equivalent Privacy, an encryption method that can enhance network security. WEP can be enabled or disabled. If it is enabled, you must enable it with the correct settings on your machine to join the network.

Network Mode

The network mode can be infrastructure, where all wireless stations communicate through an access point (AP), or ad-hoc, where wireless stations communicate directly with each other. You must set your machine to the same mode as any wireless network you wish to join.

Channel

A channel is one of 14 groups of adjacent frequencies in the band used for wireless networking. Not all channels are available in all countries. A station in infrastructure mode automatically finds the channel used by any access point (AP) it is within range of. In ad-hoc mode, all stations must be set manually to use the same channel.

The **Site Survey** section offers the following command functions:

- To change the order in which site survey results are displayed, click a column heading.

For example, you can click the **WEP** column heading to have all networks where WEP is disabled listed before all networks where WEP is enabled.

- To see all of an SSID that exceeds the width of the **SSID** column, place the pointer on that SSID.

Continuation dots show when an SSID is too long for the **SSID** column. Sometimes you might have to click the SSID. You can also widen the **SSID** column by dragging the **BSSID** column's left edge to the right.

- To search again for wireless networks in your vicinity, choose the **Search** button.

The utility will “listen” for five seconds and then display the results.

7.1.2 Connection Profiles Section

The **Connection Profiles** section shows information about profiles you have created. A connection profile contains all the settings you need to connect to a particular wireless network. You can have profiles for any number of wireless networks.

In addition to each profile's name, this section shows the network SSID and basic WEP setting (enabled or disabled). Profiles are initially shown in the order in which they were created.

- To change the order in which profiles are displayed, click a column heading.

For example, you can click the **SSID** column heading to have profiles listed according to the alphabetical order of their SSIDs.

- To see all of a profile name or SSID that exceeds the width of the column it is in, place the pointer on the truncated text.

Continuation dots show when text is too long for the column it is in. Sometimes you might have to click the text. You can also widen a column by dragging the next column's left edge to the right.

- To select a profile for examination, editing, activation, or removal, click anywhere on its line in the listing.

Double-clicking a profile is the same as selecting it and choosing **Apply**. To select multiple profiles for removal, use conventional Microsoft Windows techniques: Ctrl-click to add an individual profile to the selection, Shift-click to specify the last profile in a contiguous range. (Ctrl-click will also de-select a selected profile.)

The buttons at the bottom of the **Connection Profiles** section let you examine, edit, create, activate, and delete profiles.

Details

To examine or edit a profile, select it in the listing and choose **Details**. The profile editor will appear (see [section 7.2, “The Profile Editor,”](#) below).

New

To create a new profile, choose **New** at any time. The profile editor will appear (see [section 7.2, “The Profile Editor,”](#) below).

Apply

To use a profile to join a wireless network, select the profile and choose **Apply**. Double-clicking a profile has the same effect. You will be asked for confirmation. When you confirm the command, the utility will put all the settings in the profile into effect and attempt to join the network.

When a connection attempt is successful, the utility icon in the system tray (also known as the notification area) shows a green screen and radio waves. The screen of the icon in the top left corner of the utility’s main window also turns green (both icons show red screens when you are not connected).

Remove

To delete a profile or profiles, select the profile(s) and choose **Remove**. You will be asked for confirmation. When you confirm the command, the profile(s) will immediately be permanently deleted.

7.2 The Profile Editor

The profile editor is the dialog box that appears when you choose **Details** or **New** in the utility’s **Settings** panel. It contains all the controls you need to create settings for a wireless network connection. Each of these controls is explained in a section of its own below.

7.2.1 Profile Name

The **Profile Name** control is a text input box for giving the profile a name. Each profile must have a unique name. A profile name can be any length, but it cannot contain spaces. The case of any letters you type is preserved. When you are editing an existing profile, the name appears on a gray background here and cannot be edited.

7.2.2 SSID

The **SSID** control is a text input box for typing the target network’s Service Set Identifier, also known as the (wireless) network name (or ID), (wireless) domain name (or ID), or Extended Service Set Identifier (ESSID). All devices on a wireless network must use the same SSID. When you are within range of a wireless network, you can learn the SSID from the **Settings** panel’s **Site Survey** section (if it is unusually long, you might have to click it there to see all of it). Be sure to type it in correctly here.

7.2.3 Transmission Rate

The **Transmission Rate** control is a drop-down list box for selecting a communication speed setting. The default setting is **Auto**, that is, automatic speed detection and adjustment. **Auto** is the only setting allowed on an infrastructure network or a high-speed ad-hoc network. When the

setting of the **Transmission Rate** control is fixed because of the **Network Mode** setting, it is shown in gray characters and the control is disabled.

When the **Network Mode** control is set to **802.11 Ad-hoc**, the **Transmission Rate** control offers five settings: **Auto**, **1 Mbps**, **2 Mbps**, **5.5 Mbps**, and **11 Mbps**.

Using a fixed, high speed throughout a network can improve security by reducing the effective range. Fixed, low speeds may be necessary for interoperation with some pre-802.11b devices. The **Auto** setting lets the adapter adjust communication speed according to signal quality; this setting thus offers the best combination of throughput, range, and resistance to interference.

7.2.4 Network Mode

The **Network Mode** control is a drop-down list that offers three settings: **802.11 Ad-hoc**, **Infrastructure**, and **High Speed Ad-hoc**. You can learn from the **Settings** panel's **Site Survey** section if a network is in ad-hoc or infrastructure mode; the network installer or operator can tell you if an ad-hoc network is high-speed (22 Mbps). You must choose the setting that agrees with the actual operating mode of the network. High-speed ad-hoc mode can only be used by devices in the same product family as your adapter.

7.2.5 Channel

Depending on which part of the world you are in, there can be up to 14 “channels” in the radio frequency band used for wireless networking (2.4 to 2.4835 GHz in most countries). A channel consists of 23 exact frequencies spaced 1 MHz apart for a total spread of 22 MHz. Such spreading is required by regulatory agencies to reduce interference among devices operating in this band.

On an infrastructure network, each access point (AP) is set to use a fixed channel, and stations automatically detect the channel used by the AP that provides the best signal quality. The **Channel** control is therefore disabled when the **Network Mode** control is set to **Infrastructure**.

An ad-hoc network operates on a fixed channel that will be shown in the **Settings** panel's **Site Survey** section. To join a given ad-hoc network, you must select the correct channel from the **Channel** control's drop-down list. The settings offered in the list depend on the regulations of the country in which the adapter was purchased.

APs with overlapping coverage areas, or different ad-hoc networks operating in the same area, should use channel settings that are at least four, and preferably five channels apart (for example, 1, 6, and 11) to avoid interference and obtain the best possible performance.

7.2.6 Power Saving Mode

The **Power Saving Mode** control is a drop-down list that offers three settings: **Continuous Access Mode**, **Maximum Power Save**, and **Fast Power Save**.

In Continuous Access mode, your adapter's receiver is always on.

Maximum Power Save mode is a “doze” mode in which the adapter turns its receiver off but “wakes up” at fixed intervals to see if any communications are waiting for it. Before entering this mode, it tells the AP (or, on an ad-hoc network, the current coordinating station) that it is going to do so. The AP (or coordinating station) will “buffer” (temporarily store) communications

destined for your machine. The adapter stays “awake” only long enough to check for and receive waiting communications.

Fast Power Save mode is like Maximum Power Save mode except that the adapter checks the activity level on the network and stays fully “awake” if the activity level is high. When network traffic falls below a certain level, the adapter returns to “doze” mode.

7.2.7 Auth. Mode

The **Auth. Mode** (Authentication Mode) control is the first control in the **Encryption** section of the profile editor dialog box. It is a drop-down list offering three settings: **Open Authentication**, **Shared Authentication**, and **Auto Switch**.

The setting of this control is ignored when WEP is disabled.

A machine must request permission to join a wireless network. On some networks where WEP is enabled, a request to join must be WEP-encrypted; on others, it must not.

In Open Authentication mode, requests to join the network are never WEP-encrypted. In Shared Authentication mode, all requests to join must be WEP-encrypted. The default setting, **Auto Switch**, causes the utility to encrypt its first request and then send a non-encrypted request if the encrypted request is denied or ignored.

7.2.8 Passphrase

A “passphrase” is a string of characters from which the utility will generate a WEP key or keys. The **Passphrase** control is a text input box for typing a passphrase. This box accepts input only when the **Method** control (see [next section](#)) has been set to **64 bits**, **128 bits**, or **256 bits** (selecting one of these three settings is the first step in enabling WEP).

A passphrase can be any length, and it can contain any characters that you can type on your machine, including spaces.

To use the passphrase method of generating WEP keys, (1) make sure the **Method** control is set to the right key length, (2) select the **Passphrase** control, (3) type in a passphrase, and (4) choose the **Generate** button.

The passphrase and the generated key or keys are shown on your screen only in the current profile editor session. If you save the profile and later open it for editing, the **Passphrase** box will be blank and the key input boxes will show only asterisks.

All wireless networking products made by the manufacturer of your adapter will generate the same key or keys from a given passphrase. To use a passphrase-generated key on a product from another company, you must write down the generated values and type them in one by one in the configuration software for that product.

7.2.9 Method

The **Method** control is a drop-down list for selecting a WEP setting. Four settings are offered: **Disable**, **64 bits**, **128 bits**, and **256 bits**.

(So-called 40-bit WEP encryption is the same as that offered by the **64 bits** setting. On all wireless networking products, only 40 bits of a 64-bit key, and 104 bits of a 128-bit key, are input by the user.)

The default setting is **Disable**. Selecting any other setting enables the WEP key input controls (for example, the **Passphrase** input box and **Generate** button). WEP itself is not enabled in the profile until you complete WEP key input.

Selecting **64**, **128**, or **256 bits** also causes input boxes to appear. These boxes show and accept only “hex” (hexadecimal, that is, base 16) notation. In hex, the numbers 0 through 9 and the letters A through F are all considered digits (the letters stand for the values we normally refer to as ten through fifteen). When typing into one of these boxes you must type two hex digits, or your input is considered incomplete.

If you select **64 bits**, boxes for four WEP keys appear; a **Default Key** control is also displayed. The **Default Key** control is a drop-down list for indicating which of the four keys is currently in use on the network. The current key must be selected here, or you will not be able to connect.

If you select **128 bits**, thirteen boxes for a single key will appear.

The **256 bits** setting can only be used on connections to devices in the same product family as your adapter. Selecting **256 bits** causes 29 input boxes to appear.

A WEP key may be supplied to you in the form of a passphrase, a series of values in hex, or a plain text string that is not a passphrase.

- See [the preceding section](#) for instructions on using a passphrase.
- If you are given a key or keys in hex, type the values directly into the hex input boxes.
- A plain text string must be converted into hexadecimal notation for input. Consult the conversion charts in [appendix A](#), and then type the correct values directly into the hex input boxes.

Appendix A: Character Conversion Charts

These charts show both control codes and printable characters. Control codes (including DEL) have no standard printed representations and are unlikely to appear in plain-text WEP keys; they are included for completeness only.

Printable characters appear in the punctuation/numbers, symbols/diacritics, uppercase, and lowercase columns. Each is followed by an equals sign and a numeric value in hexadecimal notation. Type the value into the appropriate WEP key hex input box. To input the WEP key Mimsy, for example, you would type 4D, 69, 6D, 73, and 79 into the boxes for the key.

Hexadecimal Character Code Conversion Charts

1. American Standard Code for Information Interchange (ASCII)

Control Codes		Punct./Num.		Uppercase		Lowercase	
00=NUL=^@	10=DLE=^P	SP=20	0=30	@=40	P=50	`=60	p=70
01=SOH=^A	11=DC1=^Q	!=21	1=31	A=41	Q=51	a=61	q=71
02=STX=^B	12=DC2=^R	"=22	2=32	B=42	R=52	b=62	r=72
03=ETX=^C	13=DC3=^S	#=23	3=33	C=43	S=53	c=63	s=73
04=EOT=^D	14=DC4=^T	\$=24	4=34	D=44	T=54	d=64	t=74
05=ENQ=^E	15=NAK=^U	%=25	5=35	E=45	U=55	e=65	u=75
06=ACK=^F	16=SYN=^V	&=26	6=36	F=46	V=56	f=66	v=76
07=BEL=^G	17=ETB=^W	'=27	7=37	G=47	W=57	g=67	w=77
08=BS=^H	18=CAN=^X	(=28	8=38	H=48	X=58	h=68	x=78
09=HT=^I	19=EM=^Y)=29	9=39	I=49	Y=59	i=69	y=79
0A=LF=^J	1A=SUB=^Z	*=2A	: =3A	J=4A	Z=5A	j=6A	z=7A
0B=VT=^K	1B=ESC=^[+ =2B	; =3B	K=4B	[=5B	k=6B	{ =7B
0C=FF=^L	1C=FS=^\	, =2C	< =3C	L=4C	\ =5C	l=6C	=7C
0D=CR=^M	1D=GS=^]	--=2D	= =3D	M=4D] =5D	m=6D	} =7D
0E=SO=^N	1E=RS=^^	. =2E	> =3E	N=4E	^ =5E	n=6E	~ =7E
0F=SI=^O	1F=US=^_	/ =2F	? =3F	O=4F	_ =5F	o=6F	?F=DEL

2. ISO 8859-1 Extension to ASCII

Control Codes		Symb./Diac.		Uppercase		Lowercase	
80=PAD	90=DCS	NBS=A0	^=B0	À=C0	Ð=D0	à=E0	ð=F0
81=HOP	91=PU1	ı=A1	±=B1	Á=C1	Ñ=D1	á=E1	ñ=F1
82=BPH	92=PU2	ç=A2	²=B2	Â=C2	Ò=D2	â=E2	ò=F2
83=NBH	93=STS	£=A3	³=B3	Ã=C3	Ó=D3	ã=E3	ó=F3
84=IND	94=CCH	¤=A4	´=B4	Ä=C4	Ô=D4	ä=E4	ô=F4
85=NEL	95=MW	¥=A5	µ=B5	Å=C5	Õ=D5	å=E5	õ=F5
86=SSA	96=SPA	=A6	¶=B6	Æ=C6	Ö=D6	æ=E6	ö=F6
87=ESA	97=EPA	§=A7	·=B7	Ç=C7	×=D7	ç=E7	÷=F7
88=HTS	98=SOS	¨=A8	¸=B8	È=C8	Ø=D8	è=E8	ø=F8
89=HTJ	99=SGCI	©=A9	¹=B9	É=C9	Ú=D9	é=E9	ù=F9
8A=VTS	9A=SCI	ª=AA	º=BA	Ê=CA	Û=DA	ê=EA	ú=FA
8B=PLD	9B=CSI	«=AB	»=BB	Ë=CB	Ü=DB	ë=EB	ü=FB
8C=PLU	9C=ST	¬=AC	¼=BC	Ì=CC	Û=DC	ì=EC	ü=FC
8D=RI	9D=OSC	--=AD	½=BD	Í=CD	Ý=DD	í=ED	ý=FD
8E=SS2	9E=PM	®=AE	¾=BE	Î=CE	Þ=DE	î=EE	þ=FE
8F=SS3	9F=APC	¯=AF	¿=BF	Ï=CF	ß=DF	ï=EF	ÿ=FF

Appendix B: Troubleshooting

Problem: Adapter installation appears to have failed.

Solutions:

- Make sure the adapter is firmly seated in the CardBus slot.
- Uninstall and reinstall the adapter. If the problem persists, uninstall the adapter and install it in another slot. If possible, try the adapter in another computer to see if the problem is in the adapter or the computer.
- Check to see if there is an IRQ conflict with another device:
 1. Open the **Start** menu, go to **Settings**, choose **Control Panel**, open the **System** icon, choose **Device Manager**, and open the **Network adapters** entry. If an exclamation mark [!] appears on the adapter icon, select the icon and choose **Properties**.
 2. Under **Conflicting device list** in the **Resources** panel of the **Properties** dialog box, you will see a device conflict message.
 3. Uncheck **Use automatic settings** and choose the **Change Setting** button.
 4. Select a new IRQ value. When the message “No conflicts” appears in the **Properties** dialog box, close all windows by choosing **OK**, and then restart the computer.

Problems: (1) The adapter fails to function. (2) The adapter’s LEDs are both off. (3) The operating system does not detect the adapter.

Solution: These problems may be caused by unsuccessful installation. If you are sure that the adapter is firmly seated in a working slot and has not been turned off through the software, we recommend that you completely uninstall the adapter, the driver, and the utility, and then repeat the installation procedures described in this manual.

Problem: You cannot join a network that currently appears in the Settings panel’s Site Survey section.

Solution: Make sure the computer has the same SSID and security settings as the access point or (in the case of an ad-hoc network) whatever device represents the network in the **Site Survey** listing.

- **SSID:** The SSID is case-sensitive. Every device on a wireless network must use exactly the same SSID.
- **Security:** If the **Site Survey** list shows that WEP is disabled on the network, WEP must be disabled on your machine. If WEP is enabled on the network, it must be enabled with the same key length and contents on your machine.

In addition, if WEP is enabled, the **Auth. Mode** control must be set to either **Auto Switch** or the mode used on the network (open authentication or shared authentication).

If the network is in ad-hoc mode, in addition to using the correct SSID and security settings, you must use the channel indicated in the **Site Survey** section and set the transmission rate to **Auto** or the exact fixed speed used on the network.

Remember that high-speed ad-hoc mode and 256-bit WEP encryption can be used only on connections to devices in the same product line as your adapter.

Select the connection profile for the network, choose **Details**, edit the profile, choose **OK**, and choose **Apply** to put the new settings into effect.

Problem: An initially good wireless link fails, or the link alternates between good and bad (the utility icon in the system tray goes from green to red, or constantly alternates between green and red).

Solutions:

- On an ad-hoc network, the link may go up and down for a short while until the network adjusts to the addition of a new member. A different BSSID may appear in the **Information** panel each time the link comes back. The link should quickly stabilize; try the solutions below only if the problem persists.
- The computer may be too far from the access point (or the nearest ad-hoc network member). If possible, move closer. In some cases, changing the orientation of the antenna (on one device or both) can help.
- There may be interference from a microwave oven, cordless phone, or remote control. Shut down the interfering device, move it further away, or move away from it. If channel selection is under your control, setting the access point (or all members of an ad-hoc network) to use a different channel may solve the problem.
- Objects in the vicinity may be blocking or reflecting the signal. Metallic and other high-density objects affect radio signals the most, but even a tinted or wet window can reduce signal quality. Signal reflection, even from a remote object, can cause serious “multipath distortion” (this also causes “ghosts” on television screens). Try a different location (sometimes a small shift is all that is needed), or, if possible, move objects that may be affecting reception.
- Make sure the access point (or ad-hoc network member) is working correctly. Check all antennas, connectors, and cables.

Problem: A working, nearby access point does not appear in the Site Survey listing.

Solutions:

- Check the range, and check the environment for interference, signal absorption, and signal reflection (see preceding).
- The access point may be set not to broadcast its SSID. If possible, change the setting; otherwise, contact your dealer to see if an updated driver is available for the adapter.

Appendix C: Technical Support

If you encounter a problem that cannot be solved by following the steps in the [troubleshooting section](#), call your networking equipment supplier for help. Have the following information ready before you make the call:

- Full product name and, if possible, firmware version number
- Version numbers of all software products included in the package
- Operating system name and version
- Network type and configuration, and any recent configuration changes
- Actions that led to the situation that prompted the call
- LED status and any on-screen messages seen in connection with the problem

If it appears that a return or exchange will be required, you may be asked to provide the serial number of the product.

Support personnel may ask you to try to reproduce the problem. They may also ask you to run some simple tests using diagnostic tools included with the system. Proper preparation on your part can greatly reduce the amount of time needed to solve the problem.

Appendix D: Limited Warranty

Hardware

The manufacturer warrants its products to be free of defects in workmanship and materials, under normal use and service, for a period of 12 months from the date of purchase from the manufacturer or its authorized reseller, and for the period of time specified in the documentation supplied with each product.

Should a product fail to be in good working order during the applicable warranty period, the manufacturer will, at its option and expense, repair or replace it, or deliver to the purchaser an equivalent product or part at no additional charge except as set forth below. Repair parts and replacement products are furnished on an exchange basis and will be either reconditioned or new. All replaced products and parts will become the property of the manufacturer. Any replaced or repaired product or part has a warranty of ninety (90) days or the remainder of the initial warranty period, whichever is longer.

The manufacturer shall not be liable under this warranty if its testing and examination disclose that the alleged defect in the product does not exist or was caused by the purchaser's or any third party's misuse, neglect, improper installation or testing, unauthorized attempt at repair or modification, or any other cause beyond the range of the intended use, or by accident, fire, lightning, or other hazard.

Software

Software and documentation materials are supplied "as is," without warranty as to their performance, merchantability, or fitness for any particular purpose. However, the media containing the software is covered by a 90-day warranty that protects the purchaser against failure within that period.

Limited Warranty Service Procedure

Any product **(1)** received in error, **(2)** received in a defective or non-functioning condition, or **(3)** exhibiting a defect under normal working conditions, can be returned to the manufacturer by following these steps:

1. Prepare the following in printed or electronic form:
 - Dated proof of purchase
 - Product model number and quantity
 - Product serial number
 - Precise reason for return
 - Your name, address, email address, phone number, and fax number
2. Inform the distributor or retailer.
3. Ship the product back to the distributor/retailer with freight charges prepaid. The purchaser must pay the cost of shipping from the distributor/retailer to the manufacturer. Any package sent C.O.D. (Cash On Delivery) will be refused.

Charges: Usually, RMA (Returned Material Authorization) items will be returned to the purchaser via airmail, prepaid by the manufacturer. If any item is returned by another carrier, the purchaser will pay the difference. A return freight and handling fee will be charged to the purchaser if the manufacturer determines that the product is not defective or that the damage was caused by the user.

Warning

The manufacturer is not responsible for the integrity of any data on storage equipment (hard drives, tape drives, floppy diskettes, etc.). We strongly recommend that our customers back their data up before sending such equipment in for diagnosis or repair.

Service After Warranty Period

After the warranty period expires, all products can be repaired for a reasonable service charge. The shipping charges to and from the manufacturer's facility will be borne by the purchaser.

Return for Credit

In the case of a DOA item (an item that is "dead on arrival") or a shipping error, a return for credit will automatically be applied to the purchaser's account, unless otherwise requested.

Limitation of Liability

All expressed and implied warranties of a product's merchantability, or of its fitness for a particular purpose, are limited in duration to the applicable period as set forth in this limited warranty, and no warranty will be considered valid after its expiration date.

If this product does not function as warranted, your sole remedy shall be repair or replacement as provided for above. In no case shall the manufacturer be liable for any incidental, consequential, special, or indirect damages resulting from loss of data, loss of profits, or loss of use, even if the manufacturer or its authorized distributor/dealer has been advised of the possibility of such damages, or for any claim by any other party.

Appendix E: Specifications

Standards compliance	IEEE 802.11b, PCMCIA CardBus (Type II)
Regulatory compliance	USA: FCC Part 15 Class B EU: ETS 300.328, ETS 300.826, CE Mark Japan: ARIB STD-T66
Frequency band	2400.0 to 2497.0 MHz (Japan) 2400.0 to 2483.5 MHz (North America and Europe) 2445.0 to 2475.0 MHz (Spain) 2446.5 to 2483.5 MHz (France)
Transmitter power	15 dBm (typical)
Receiver sensitivity*	11 Mbps: -82 dBm (typical) 22 Mbps: -78 dBm (typical)
* Minimum receiver input power level at which a frame error ratio (FER) of less than 8% can be maintained, given a packet length of 1024 bytes and conditions of 20° to 30° C.	
Input power	DC 3.3V ±5%
Power consumption	550 mA/3.3V (transmitting), 350 mA/3.3V (receiving)
Data rates	11, 5.5, 2, and 1 Mbps with auto fallback Special user-selectable 22 Mbps option
RF spreading scheme	Direct-sequence spread-spectrum (DSSS)
Encoding and modulation methods	1 Mbps: Barker sequence + BPSK 2 Mbps: Barker sequence + QPSK 5.5 and 11 Mbps: CCK/PBCC 22 Mbps: PBCC
Security	64- and 128-bit Wired Equivalent Privacy (WEP) encryption Special user-selectable 256-bit WEP option
Antenna	Internal printed diversity type
LED indicators	Two: power on/off (green) and wireless activity (orange)
Dimensions (L × W × H)	118 × 54 × 9 mm
Environmental requirements	Operating temperature: 0° to 50° C Storage temperature: -30° to 70° C Operating humidity: Tested to RH 85% at 40° C (104° F) for 48 hours
Accompanying software	Drivers for Microsoft Windows 98/ME (NDIS 5.0), 2000 (NDIS 5.0), and XP (NDIS 5.1); configuration utility with connection profile management for multiple networks

Appendix F: Channels and Regulations

The following table lists the IEEE 802.11b transmission channels and provides important notes on regulations regarding channel use.

Channel	Start, Center, and End Frequencies (MHz)	Non-overlapped Channels	Notes
1	2401 2412 2423	6-14	1
2	2406 2417 2428	7-14	1
3	2411 2422 2433	8-14	1
4	2416 2427 2438	9-14	1
5	2421 2432 2443	10-14	1
6	2426 2437 2448	1, 11-14	1
7	2431 2442 2453	1, 2, 12-14	1
8	2436 2447 2458	1-3, 13, 14	1
9	2441 2452 2463	1-4, 14	1
10	2446 2457 2468	1-5, 14	
11	2451 2462 2473	1-6	
12	2456 2467 2478	1-7	2
13	2461 2472 2483	1-8	2
14	2473 2484 2495	1-10	3

Notes: 1. Not used where the regulations of Spain or France are in effect.
 2. Not used where the regulations of Spain or North America are in effect.
 3. Used only where the regulations of Japan are in effect.

An illustration of IEEE 802.11b channel distribution and overlap appears below.

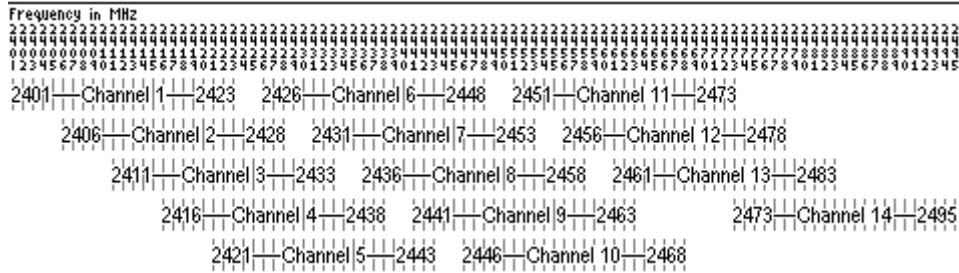

Wireless networking channels in the 2.4-GHz frequency band