

REALTEK

RTL8192DE

802.11a/b/g/n RTL8192DE miniCard User's Manual

Rev. 1.0
08 Apr 2011



Realtek Semiconductor Corp.

No. 2, Innovation Road II, Hsinchu Science Park, Hsinchu 300, Taiwan

Tel.: +886-3-578-0211. Fax: +886-3-577-6047

www.realtek.com.tw

COPYRIGHT

©2011 Realtek Semiconductor Corp. All rights reserved. No part of this document may be reproduced, transmitted, transcribed, stored in a retrieval system, or translated into any language in any form or by any means without the written permission of Realtek Semiconductor Corp.

DISCLAIMER

Realtek provides this document “as is”, without warranty of any kind, neither expressed nor implied, including, but not limited to, the particular purpose. Realtek may make improvements and/or changes in this document or in the product described in this document at any time. This document could include technical inaccuracies or typographical errors.

TRADEMARKS

Realtek is a trademark of Realtek Semiconductor Corporation. Other names mentioned in this document are trademarks/registered trademarks of their respective owners.

USING THIS DOCUMENT

This document is intended for the software engineer’s reference and provides detailed programming information.

Though every effort has been made to ensure that this document is current and accurate, more information may have become available subsequent to the production of this guide. In that event, please contact your Realtek representative for additional information that may help in the development process.

Table of Contents

1. GENERAL DESCRIPTION.....	1
2. FEATURES.....	2
3. PRODUCT SPECIFICATIONS.....	4
3.1. MINI PCI EXPRESS PIN ASSIGNMENT	4
3.2. MECHANICAL	5
3.3. ENVIRONMENTAL	5
3.3.1. <i>Operating</i>	5
3.3.2. <i>Storage</i>	5
3.4. FUNCTIONAL SPECIFICATIONS	5
3.5. WARNING	7
3.5.1 <i>Federal Communication Commission Interference Statement</i>	7
3.5.2 <i>Industry Canada Statement</i>	8
3.5.3 <i>NCC 警語</i>	12

List of Tables

TABLE 1. MINI PCI EXPRESS PIN ASSIGNMENT	4
TABLE 2. FUNCTIONAL SPECIFICATIONS	5

List of Figures

FIGURE 1. RTL8192DE HALF MINI-CARD MECHANICAL SPECIFICATION.....	5
--	---

1. General Description

The Realtek RTL8192DE is a highly integrated single-chip MIMO (Multiple In, Multiple Out) Wireless LAN (WLAN) PCI Express network interface controller complying with the wireless high throughput IEEE 802.11n specification. It combines a configurable dual MAC, 2T2R capable baseband and 2.4GHz/5GHz band RF in a single chip. The RTL8192DE provides a complete solution for a high-performance wireless client.

The RTL8192DE implements dual MAC by PCI Express multi-function capability. The dual MAC feature enables RTL8192DE to access two different wireless networks and to act as an WiFi station and an AP concurrently. The RTL8192DE also supports WiFi Direct feature that can easily build a WiFi P2P PAN network.

The RTL8192DE baseband implements Multiple Input, Multiple Output (MIMO) Orthogonal Frequency Division Multiplexing (OFDM) with two transmit and two receive paths (2T2R). Features include two spatial stream transmissions, short Guard Interval (GI) of 400ns, spatial spreading, and support for both 20MHz and 40MHz channel bandwidth. Moreover, RTL8192DE provides one spatial stream space-time block code (STBC) to extend the range of transmission. At the receiver, extended range and good minimum sensitivity is achieved by having receiver diversity up to 2 antennas. As the recipient, the RTL8192DE also supports explicit sounding packet feedback that helps senders with beamforming capability. With 2 independent RF blocks, the RTL8192DE can perform fast roaming without link interruption.

For legacy compatibility, Direct Sequence Spread Spectrum (DSSS), Complementary Code Keying (CCK) and OFDM baseband processing are included to support all IEEE 802.11b, 802.11g and 802.11a data rates. Differential phase shift keying modulation schemes, DBPSK and DQPSK with data scrambling capability are available, and CCK provides support for legacy data rates, with long or short preamble. The high speed FFT/IFFT paths, combined with BPSK, QPSK, 16QAM, and 64QAM modulation of the individual subcarriers, and rate compatible punctured convolutional coding with coding rate of 1/2, 2/3, 3/4, and 5/6, provide the higher data rates than 54Mbps upto 300Mbps for IEEE 802.11n MIMO OFDM respectively.

The RTL8192DE builds in an enhanced signal detector, an adaptive frequency domain equalizer, and a soft-decision Viterbi decoder to alleviate severe multi-path effects and mutual interference in the reception of multiple streams. For better detection quality, receive diversity with Maximal-Ratio-Combine (MRC) applying up to two receive paths is implemented. Robust interference detection and suppression are provided to protect against Bluetooth, cordless phone, and microwave oven interference.

Receive vector diversity for multi-stream application is implemented for efficient utilization of the MIMO channel. Efficient IQ-imbalance, DC offset, phase noise, frequency offset, and timing offset compensations are provided for the radio frequency front-end. Selectable digital transmit and receive FIR filters are

provided to meet transmit spectrum mask requirements and to reject adjacent channel interference, respectively.

The RTL8192DE supports fast receiver Automatic Gain Control (AGC) with synchronous and asynchronous control loops among antennas, antenna diversity functions, and adaptive transmit power control functions to obtain better performance in the analog portions of the transceiver.

The RTL8192DE MAC supports 802.11e for multimedia applications, 802.11i and WAPI (Wireless Authentication Privacy Infrastructure) for security, and 802.11n for enhanced MAC protocol efficiency. Using packet aggregation techniques such as A-MPDU with BA and A-MSDU, protocol efficiency is significantly improved. Power saving mechanisms such as Legacy Power Save, U-APSD, and MIMO power saving reduce the power wasted during idle time, and compensate for the extra power required to transmit MIMO OFDM. The RTL8192DE provides simple legacy and 20MHz/40MHz co-existence mechanisms to ensure backward and network compatibility.

2. Features

General

- QFN76 9x9mm package
- CMOS MAC, Baseband PHY and RF in a single chip for IEEE 802.11a/b/g/n compatible WLAN
- Complete 802.11n MIMO solution for 2.4GHz and 5GHz band
- 2x2 MIMO technology for extended reception robustness and exceptional throughput
- Maximum PHY data rate up to 144.4 Mbps using 20MHz bandwidth, 300Mbps using 40MHz bandwidth
- Complies with 802.11n specification
- Backward compatible with 802.11a/b/g devices while operating at 802.11n data rates

Host Interface

- Complies with PCI Express Base Specification Revision 1.1

Standards Supported

- IEEE 802.11a/b/g/n compatible WLAN
- IEEE 802.11e QoS Enhancement (WMM)
- IEEE 802.11i (WPA, WPA2). Open, shared key, and pair-wise key authentication services
- IEEE 802.11h TPC, Spectrum Measurement
- IEEE 802.11k Radio Resource Measurement
- WAPI (Wireless Authentication Privacy Infrastructure) certified.
- Cisco Compatible Extensions (CCX) for WLAN devices

MAC Features

- Frame aggregation for increased MAC efficiency (A-MSDU, A-MPDU)
- Low latency immediate High-Throughput Block Acknowledgement (HT-BA)
- Long NAV for media reservation with CF-End for NAV release
- PHY-level spoofing to enhance legacy compatibility
- MIMO power saving mechanism
- Channel management and co-existence
- Multiple BSSID feature allows the RTL8192DE to assume multiple MAC identities when used as a wireless bridge
- Supports Wake-On-WLAN via Magic Packet and Wake-up frame
- Transmit Opportunity (TXOP) Short Inter-Frame Space (SIFS) bursting for higher multimedia bandwidth
- Dual MAC architecture allows dual band or dual network access or behave a station and an AP concurrently.
- WiFi Direct supports wireless peer to peer applications.

Peripheral Interfaces

- General Purpose Input/Output (10 pins)
- 4-wire EEPROM control interface (93C46/93C56)
- Three configurable LED pins

- Configurable Bluetooth Coexistence Interface

PHY Features

- IEEE 802.11n MIMO OFDM
- Two Transmit and Two Receive paths (2T2R)
- 20MHz and 40MHz bandwidth transmission
- Support 2.4Ghz and 5Ghz band channels
- Short Guard Interval (400ns)
- Sounding packet
- DSSS with DBPSK and DQPSK, CCK modulation with long and short preamble
- OFDM with BPSK, QPSK, 16QAM, and 64QAM modulation.
Convolutional Coding Rate: 1/2, 2/3, 3/4, and 5/6
- Maximum data rate 54Mbps in 802.11g and 300Mbps in 802.11n
- OFDM receive diversity with MRC using up to 2 receive paths. Switch diversity used for DSSS/CCK
- Hardware antenna diversity
- Selectable digital transmit and receiver FIR filters
- Programmable scaling in transmitter and receiver to trade quantization noise against increased probability of clipping
- Fast receiver Automatic Gain Control (AGC)
- On-chip ADC

3. Product specifications

3.1. Mini PCI Express Pin Assignment

Table 1. Mini PCI Express Pin Assignment

PIN#	Pin Name		PIN#	Pin Name	
1	WAKE#	YES	2	+3.3Vaux	YES
3	RESERVED (*1)	YES	4	GND	YES
5	RESERVED (*2)	YES*	6	+1.5V	NC
7	CLKREQ#	YES	8	UIM_PWR	NC
9	GND	YES	10	UIM_DATA	NC
11	REFCLK-	YES	12	UIM_CLK	NC
13	REFCLK+	YES	14	UIM_RESET	NC
15	GND	YES	16	UIM_VPP	NC
17	RESERVED	NC	18	GND	YES
19	RESERVED	NC	20	W_DISABLE1#	YES
21	GND	YES	22	PERST#	YES
23	PERn0	YES	24	+3.3Vaux	NC
25	PERp0	YES	26	GND	YES
27	GND	YES	28	+1.5V	YES
29	GND	YES	30	SMB_CLK	NC
31	PETn0	YES	32	SMB_DATA	NC
33	PETp0	YES	34	GND	YES
35	GND	YES	36	USB_D-	YES
37	GND	YES	38	USB_D+	YES
39	+3.3Vaux	NC	40	GND	NC
41	+3.3Vaux	NC	42	LED_WWAN#	NC
43	GND	YES	44	LED_WLAN#	YES
45	RESERVED	NC	46	LED_WPAN#	NC
47	RESERVED	NC	48	+1.5V	YES
49	RESERVED	NC	50	GND	YES
51	W_DISABLE2#	NC	52	+3.3Vaux	YES

Note *1: WL_ACT

Note *2: BT_PRI

3.2. Mechanical

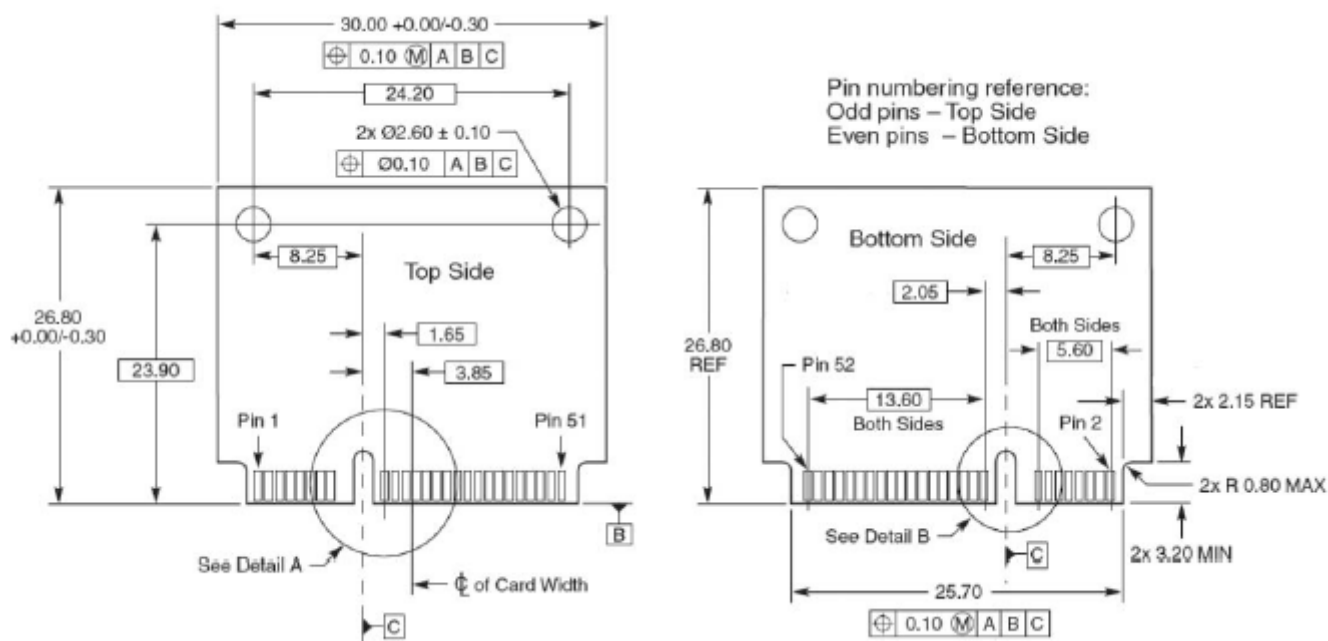

Figure 1. RTL8192DE Half Mini-Card Mechanical Specification

3.3. Environmental

3.3.1. Operating

Operating Temperature: 0 to 70 °C
 Relative Humidity: 5-90% (non-condensing)

3.3.2. Storage

Temperature: -55 to 125 °C
 Relevant Humidity: 5-95% (non-condensing)

3.4. Functional Specifications

Table 2. Functional Specifications

Standards	IEEE 802.11a, IEEE 802.11b, IEEE 802.11g, IEEE 802.11n, IEEE 802.11d, IEEE 802.11e, IEEE 802.11h, IEEE 802.11i, IEEE 802.11k
Bus Interface	PCI Express or USB
Form Factor	Half Size Mini Card
Data Rate	802.11b: 11, 5.5, 2, 1 Mbps; 802.11g: 54, 48, 36, 24, 18, 12, 9, 6 Mbps 802.11n:

	MCS 0 to 15 for HT20MHz; MCS 0 to 15 for HT40MHz
Media Access Control	CSMA/CA with ACK
Modulation Techniques	802.11b: CCK, DQPSK, DBPSK 802.11a/g/n: 64 QAM, 16 QAM, QPSK, BPSK
Network Architecture	WiFi: Ad-hoc mode (Peer-to-Peer) Infrastructure mode
Operating Channel	WiFi 2.4GHz: 11: (Ch. 1-11) – United States 13: (Ch. 1-13) – Europe 14: (Ch. 1-14) – Japan WiFi 5GHz: 20MHz band width : Ch36, 40, 44, 48, 52, 56, 60, 64, 100, 104, 108, 112, 116, 120, 124, 128, 132, 136, 140, 149, 153, 157, 161, 165. 40MHz band width : Ch38, 42, 46, 50, 54, 58, 62, 102, 106, 110, 114, 118, 122, 126, 130, 134, 138, 151, 155, 159, 163.
Frequency Range	2.400GHz ~ 2.4835 GHz 5.1500GHz ~ 5.3500GHz 5.4700GHz ~ 5.7250GHz 5.7250GHz ~ 5.8250GHz
Security	WPA, WPA-PSK, WPA2, WPA2-PSK, WEP 64bit & 128bit, IEEE 802.11x, IEEE 802.11i
Operating Voltage	3.3 V \pm 9% I/O supply voltage

3.5. Warning

3.5.1 Federal Communication Commission Interference Statement

This equipment has been tested and found to comply with the limits for a Class B digital device, pursuant to Part 15 of the FCC Rules. These limits are designed to provide reasonable protection against harmful interference in a residential installation. This equipment generates, uses and can radiate radio frequency energy and, if not installed and used in accordance with the instructions, may cause harmful interference to radio communications. However, there is no guarantee that interference will not occur in a particular installation. If this equipment does cause harmful interference to radio or television reception, which can be determined by turning the equipment off and on, the user is encouraged to try to correct the interference by one of the following measures:

- Reorient or relocate the receiving antenna.
- Increase the separation between the equipment and receiver.
- Connect the equipment into an outlet on a circuit different from that to which the receiver is connected.
- Consult the dealer or an experienced radio/TV technician for help.

This device complies with Part 15 of the FCC Rules. Operation is subject to the following two conditions: (1) This device may not cause harmful interference, and (2) this device must accept any interference received, including interference that may cause undesired operation.

FCC Caution: Any changes or modifications not expressly approved by the party responsible for compliance could void the user's authority to operate this equipment.

IMPORTANT NOTE:

FCC Radiation Exposure Statement:

This equipment complies with FCC radiation exposure limits set forth for an uncontrolled environment. This equipment should be installed and operated with minimum distance 20cm between the radiator & your body.

This transmitter must not be co-located or operating in conjunction with any other antenna or transmitter.

Operations in the 5.15-5.25GHz band are restricted to indoor usage only.

IEEE 802.11b or 802.11g operation of this product in the U.S.A. is firmware-limited to channels 1 through 11.

This device is intended only for OEM integrators under the following conditions:

- 1) The antenna must be installed such that 20 cm is maintained between the antenna and users, and
- 2) The transmitter module may not be co-located with any other transmitter or antenna,
- 3) For all products market in US, OEM has to limit the operation channels in CH1 to CH11 for 2.4G band by supplied firmware programming tool. OEM shall not supply any tool or info to the end-user regarding to Regulatory Domain change.

As long as 3 conditions above are met, further transmitter test will not be required. However, the OEM

integrator is still responsible for testing their end-product for any additional compliance requirements required with this module installed (for example, digital device emissions, PC peripheral requirements, etc.).

IMPORTANT NOTE: In the event that these conditions can not be met (for example certain laptop configurations or co-location with another transmitter), then the FCC authorization is no longer considered valid and the FCC ID can not be used on the final product. In these circumstances, the OEM integrator will be responsible for re-evaluating the end product (including the transmitter) and obtaining a separate FCC authorization.

End Product Labeling

This transmitter module is authorized only for use in device where the antenna may be installed such that 20 cm may be maintained between the antenna and users. The final end product must be labeled in a visible area with the following: “Contains FCC ID: TX2-RTL8192DE”.

Manual Information To the End User

The OEM integrator has to be aware not to provide information to the end user regarding how to install or remove this RF module in the user’s manual of the end product which integrates this module.

The end user manual shall include all required regulatory information/warning as show in this manual.

3.5.2 Industry Canada Statement

This device complies with RSS-210 of the Industry Canada Rules. Operation is subject to the following two conditions:

- 1) this device may not cause interference and
- 2) this device must accept any interference, including interference that may cause undesired operation of the device

French translation:

Ce dispositif est conforme à la norme CNR-210 d'Industrie Canada applicable aux appareils radio exempts de licence. Son fonctionnement est sujet aux deux conditions suivantes: (1) le dispositif ne doit pas produire de brouillage préjudiciable, et (2) ce dispositif doit accepter tout brouillage reçu, y compris un brouillage susceptible de provoquer un fonctionnement indésirable.

(The user manual of transmitter devices equipped with detachable antennas shall contain the following information in a conspicuous location:)

This device has been designed to operate with an antenna having a maximum gain of 5 dBi. Antenna having a higher gain is strictly prohibited per regulations of Industry Canada. The required antenna impedance is 50 ohms.

Under Industry Canada regulations, this radio transmitter may only operate using an antenna of a type and maximum (or lesser) gain approved for the transmitter by Industry Canada. To reduce potential radio interference to other users, the antenna type and its gain should be so chosen that the equivalent isotropically radiated power (e.i.r.p.) is not more than that necessary for successful communication.

French translation:

(Le manuel d'utilisation de dispositifs émetteurs équipés d'antennes amovibles doit contenir les informations suivantes dans un endroit bien en vue:)

Ce dispositif a été conçu pour fonctionner avec une antenne ayant un gain maximum de 5 dBi. Une antenne à gain plus élevé est strictement interdite par les règlements d'Industrie Canada. L'impédance d'antenne requise est de 50 ohms.

Conformément à la réglementation d'Industrie Canada, le présent émetteur radio peut fonctionner avec une antenne d'un type et d'un gain maximal (ou inférieur) approuvé pour l'émetteur par Industrie Canada. Dans le but de réduire les risques de brouillage radioélectrique à l'intention des autres utilisateurs, il faut choisir le type d'antenne et son gain de sorte que la puissance isotrope rayonnée équivalente (p.i.r.e.) ne dépasse pas l'intensité nécessaire à l'établissement d'une communication satisfaisante.

IMPORTANT NOTE:

IC Radiation Exposure Statement:

This equipment complies with IC radiation exposure limits set forth for an uncontrolled environment. This equipment should be installed and operated with minimum distance 20cm between the radiator & your body.

French translation:

NOTE IMPORTANTE: (Pour l'utilisation de dispositifs mobiles)

Déclaration d'exposition aux radiations:

Cet équipement est conforme aux limites d'exposition aux rayonnements IC établies pour un environnement non contrôlé. Cet équipement doit être installé et utilisé avec un minimum de 20 cm de distance entre la source de rayonnement et votre corps.

Caution: (DFS band usage-full bands)

(i) the device for operation in the band 5150-5250 MHz is only for indoor use to reduce the potential for harmful interference to co-channel mobile satellite systems;

(ii) the maximum antenna gain permitted for devices in the bands 5250-5350 MHz and 5470-5725 MHz shall comply with the e.i.r.p. limit; and

(iii) the maximum antenna gain permitted for devices in the band 5725-5825 MHz shall comply with the e.i.r.p. limits specified for point-to-point and non point-to-point operation as appropriate.

(iv) Users should also be advised that high-power radars are allocated as primary users (i.e. priority users) of the bands 5250-5350 MHz and 5650-5850 MHz and that these radars could cause interference and/or damage to LE-LAN devices.

French translation:

Avertissement:

Le guide d'utilisation des dispositifs pour réseaux locaux doit inclure des instructions précises sur les restrictions susmentionnées, notamment :

- (i) les dispositifs fonctionnant dans la bande 5 150-5 250 MHz sont réservés uniquement pour une utilisation à l'intérieur afin de réduire les risques de brouillage préjudiciable aux systèmes de satellites mobiles utilisant les mêmes canaux;
- (ii) le gain maximal d'antenne permis pour les dispositifs utilisant les bandes 5 250-5 350 MHz et 5 470-5 725 MHz doit se conformer à la limite de p.i.r.e.;
- (iii) le gain maximal d'antenne permis (pour les dispositifs utilisant la bande 5 725-5 825 MHz) doit se conformer à la limite de p.i.r.e. spécifiée pour l'exploitation point à point et non point à point, selon le cas.
- (iv) De plus, les utilisateurs devraient aussi être avisés que les utilisateurs de radars de haute puissance sont désignés utilisateurs principaux (c.-à-d., qu'ils ont la priorité) pour les bandes 5 250-5 350 MHz et 5 650-5 850 MHz et que ces radars pourraient causer du brouillage et/ou des dommages aux dispositifs LAN-EL.

This device is intended only for OEM integrators under the following conditions:

- 1) The antenna must be installed such that 20 cm is maintained between the antenna and users, and
- 2) The transmitter module may not be co-located with any other transmitter or antenna,

For all products market in Canada, OEM has to limit the operation channels in CH1 to CH11 for 2.4G band by supplied firmware programming tool. OEM shall not supply any tool or info to the end-user regarding to Regulatory Domain change.

As long as 3 conditions above are met, further transmitter test will not be required. However, the OEM integrator is still responsible for testing their end-product for any additional compliance requirements required with this module installed.

French translation :

Cet appareil est conçu uniquement pour les intégrateurs OEM dans les conditions suivantes: (Pour utilisation de dispositif module)

- 1) L'antenne doit être installée de telle sorte qu'une distance de 20 cm est respectée entre l'antenne et les utilisateurs, et
- 2) Le module émetteur peut ne pas être coïmplanté avec un autre émetteur ou antenne,
- 3) Pour tous les produits vendus au Canada, OEM doit limiter les fréquences de fonctionnement CH1 à CH11 pour bandes de fréquences 2.4G grâce aux outils de microprogrammation fournis. OEM ne doit pas

fournir d'outil ou d'informations à l'utilisateur final en ce qui concerne le changement de réglementation de domaine.

Tant que les 3 conditions ci-dessus sont remplies, des essais supplémentaires sur l'émetteur ne seront pas nécessaires. Toutefois, l'intégrateur OEM est toujours responsable des essais sur son produit final pour toutes exigences de conformité supplémentaires requis pour ce module installé.

IMPORTANT NOTE: In the event that these conditions can not be met (for example certain laptop configurations or co-location with another transmitter), then the IC authorization is no longer considered valid and the IC ID can not be used on the final product. In these circumstances, the OEM integrator will be responsible for re-evaluating the end product (including the transmitter) and obtaining a separate IC authorization.

French translation:

NOTE IMPORTANTE:

Dans le cas où ces conditions ne peuvent être satisfaites (par exemple pour certaines configurations d'ordinateur portable ou de certaines co-localisation avec un autre émetteur), l'autorisation du Canada n'est plus considéré comme valide et l'ID IC ne peut pas être utilisé sur le produit final. Dans ces circonstances, l'intégrateur OEM sera chargé de réévaluer le produit final (y compris l'émetteur) et l'obtention d'une autorisation distincte au Canada.

End Product Labeling

This transmitter module is authorized only for use in device where the antenna may be installed such that 20 cm may be maintained between the antenna and users. The final end product must be labeled in a visible area with the following: "Contains IC: 6317A-RTL8192DE".

French translation:

Plaque signalétique du produit final

Ce module émetteur est autorisé uniquement pour une utilisation dans un dispositif où l'antenne peut être installée de telle sorte qu'une distance de 20cm peut être maintenue entre l'antenne et les utilisateurs. Le produit final doit être étiqueté dans un endroit visible avec l'inscription suivante: "Contient des IC: 6317A-RTL8192DE".

Manual Information To the End User

The OEM integrator has to be aware not to provide information to the end user regarding how to install or remove this RF module in the user's manual of the end product which integrates this module.

The end user manual shall include all required regulatory information/warning as show in this manual.

French translation:

Manuel d'information à l'utilisateur final

L'intégrateur OEM doit être conscient de ne pas fournir des informations à l'utilisateur final quant à la façon d'installer ou de supprimer ce module RF dans le manuel de l'utilisateur du produit final qui intègre ce module.

Le manuel de l'utilisateur final doit inclure toutes les informations réglementaires requises et avertissements comme indiqué dans ce manuel.

3.5.3 NCC 警語

經型式認證合格之低功率射頻電機，非經許可，公司、商號或使用者均不得擅自變更頻率、加大功率或變更原設計之特性及功能。

低功率射頻電機之使用不得影響飛航安全及干擾合法通信；經發現有干擾現象時，應立即停用，並改善至無干擾時方得繼續使用。前項合法通信，指依電信法規定作業之無線電通信。低功率射頻電機須忍受合法通信或工業、科學及醫療用電波輻射性電機設備之干擾。

在5.25-5.35GHz頻帶內操作之無線資訊傳輸設備，限室內使用。

本模組於取得認證後將依規定於模組本體標示審合格籤，並要求平台上標示「本產品內含射頻模組：ID編號」

Installing the Wireless PCIe miniCard module

Hardware

Step 1. Shut down the computer.

Step 2. Installing PCIe MiniCard module to PCIe MiniCard connector.



Step 3. Connect two external Wi-Fi antennas on I-PEX connectors.

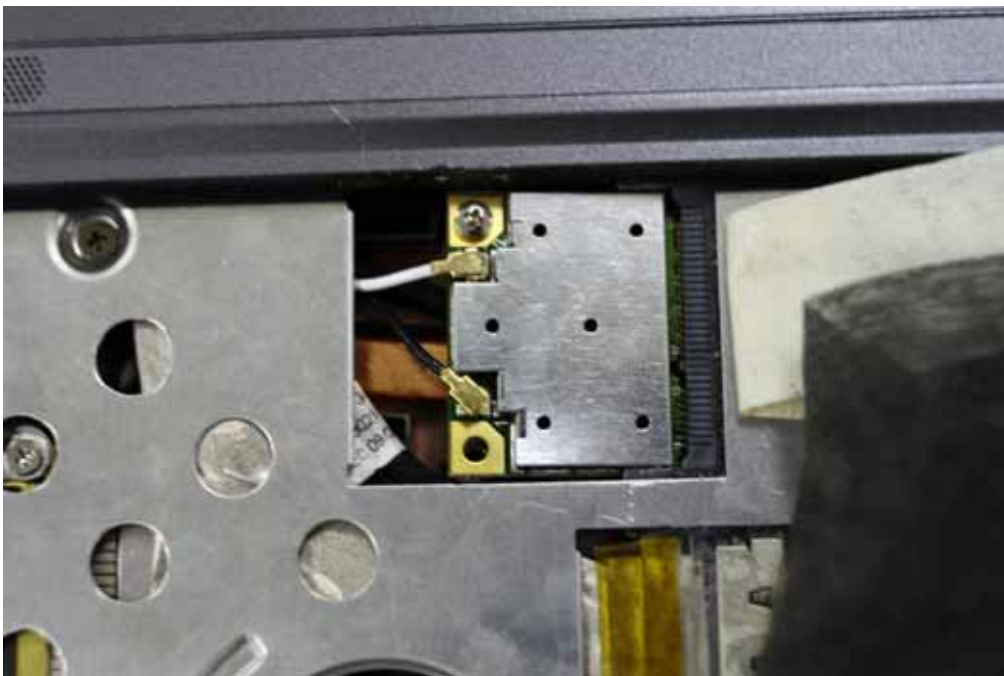

step4. Power on the computer.

Un-installing the Wireless PCIe MiniCard module Hardware

Step 1. Shut down the computer.

Step 2. Remove 2 external Wi-Fi Antennas from the Wireless PCIe MiniCard module board.



Step 3. Remove the Wireless PCIe MiniCard module board from PCIe MiniCard connector port.



Step 4. Power on the computer.

Installing the Wireless PCIe miniCard module Software

Before you proceed with the installation, please notice following descriptions.

Note1: The following installation was operated under Windows XP.

(Procedures are similar for Windows Vista/Win7.)

Note2: If you have installed the WLAN driver & utility before, please uninstall the old version first.

If you install the “Realtek11n Single Chip PCIE WLAN NIC Mass production kit” into your laptop computer before installing the software program from the CD.

A. Insert the Installation CD to your CD-ROM Drive. Execute the “setup” program.

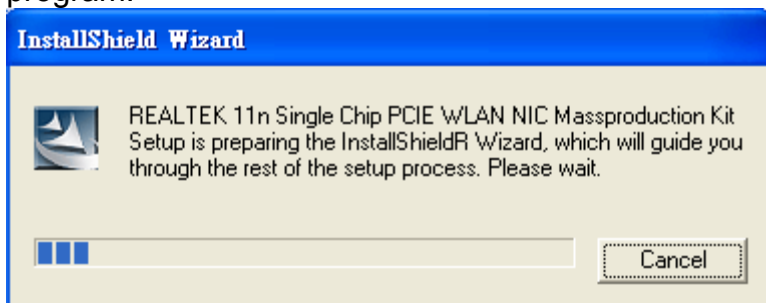

B. Click “Next” to process the installation

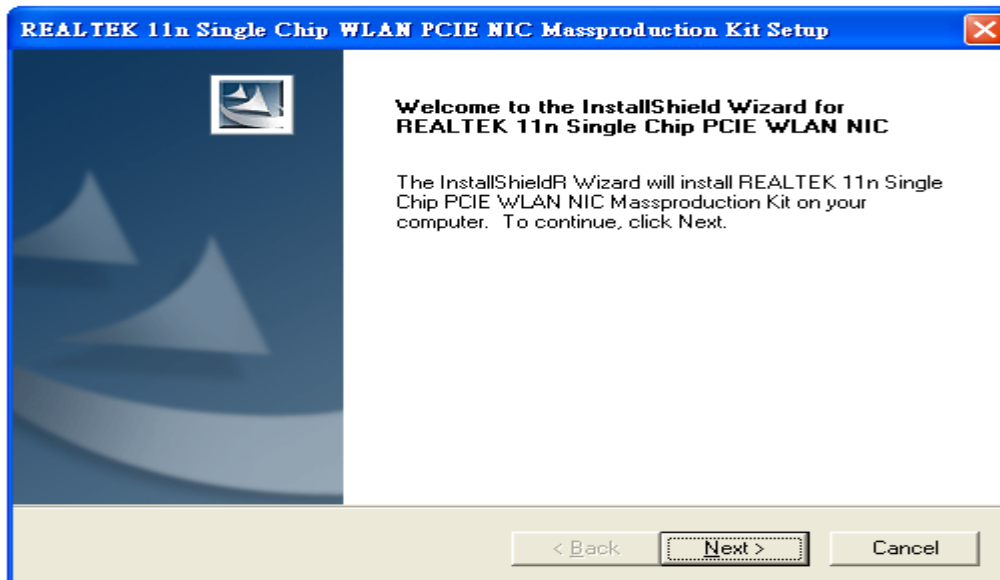

C. The system starts to install the software of the WLAN adapter.

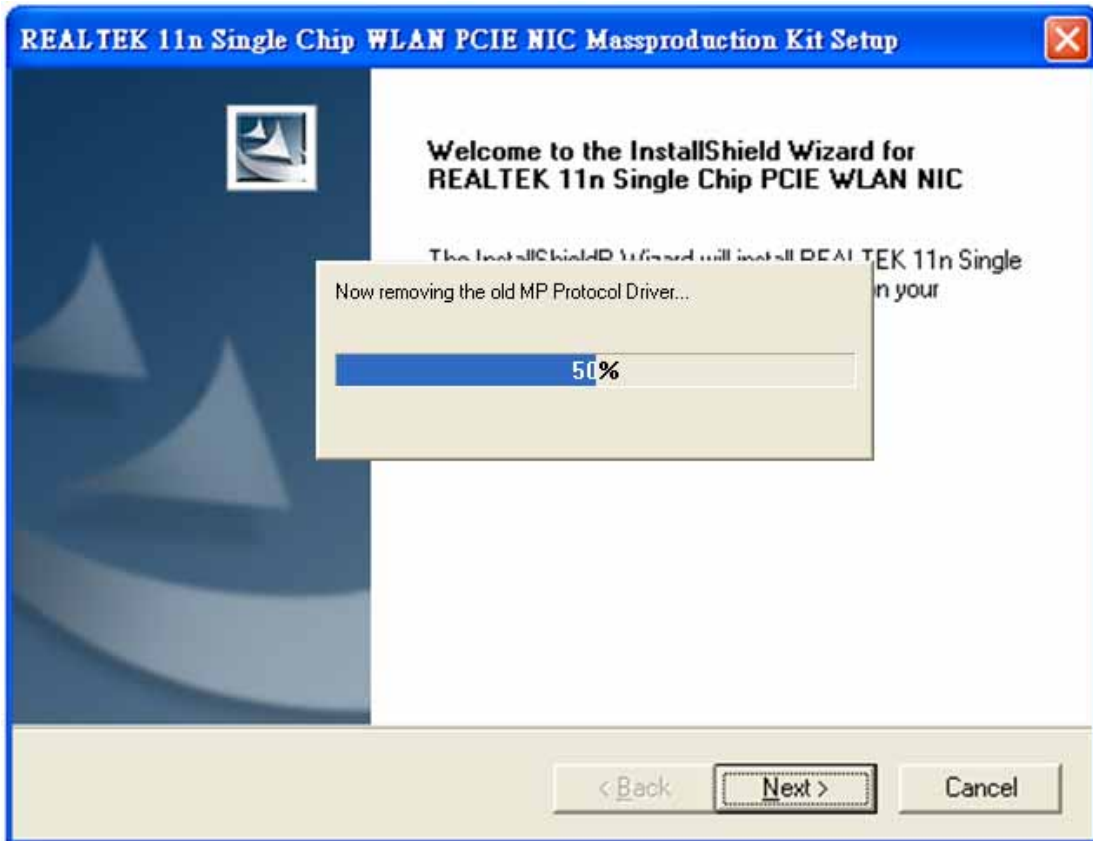

D. The system will automatically detect the card and display “Hardware Installation” screen. Click “繼續安裝” to continue.

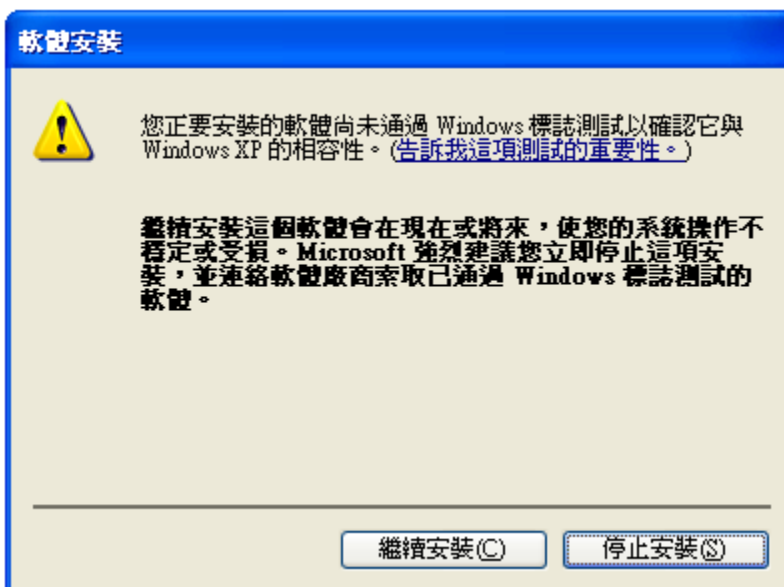

E. Please click “Finish” to complete the installation.

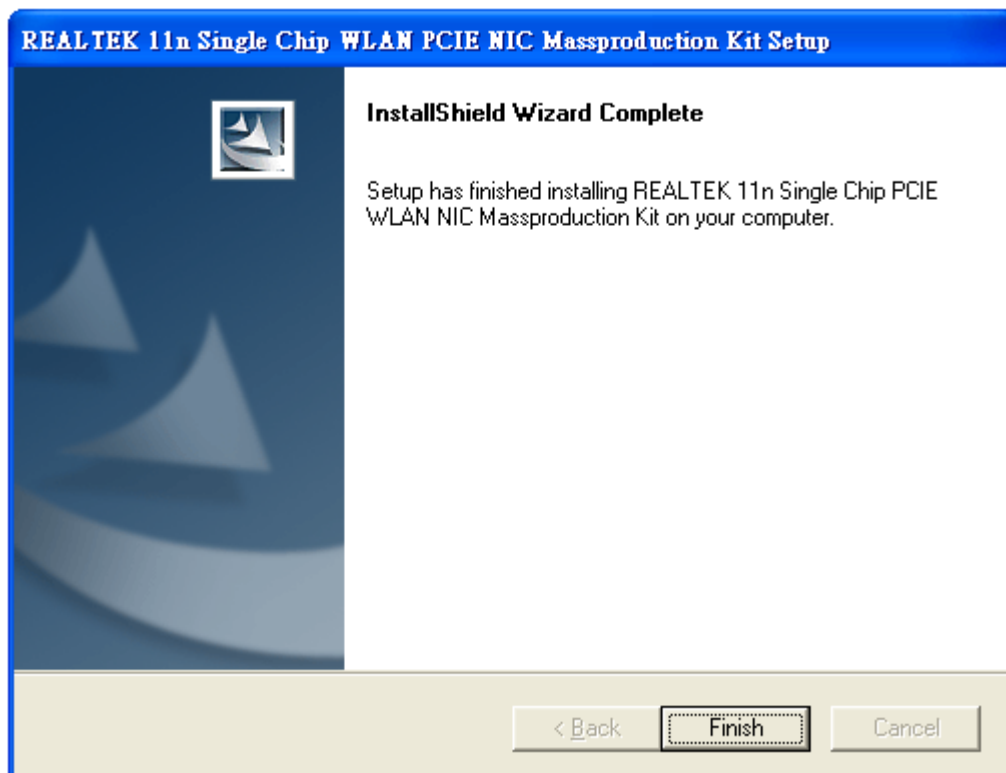

Un-installing the Wireless PCIE MiniCard module Software

If you install Realtek11n Single Chip PCIE WLAN NIC Mass production kit into your laptop computer after installing the software program from the CD.

When you install Realtek11n Single Chip WLAN PCIE MINICARD Adapter, the following dialog will be shown.

A. Uninstall the RTL8192DE WLAN Driver from “Start”→ “All Programs”→ “Realtek11n Single Chip WLAN PCIE NIC Mass production kit” or “Control Panel”→ “Change or Remove Programs”.

Please click “Un-install” (or “Change/Remove”) to remove RTL8192DE WLAN driver.

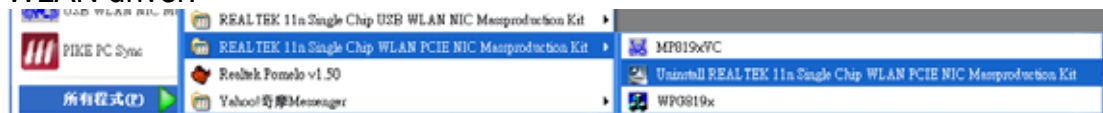

B. Please click “Finish” to complete the un-installation

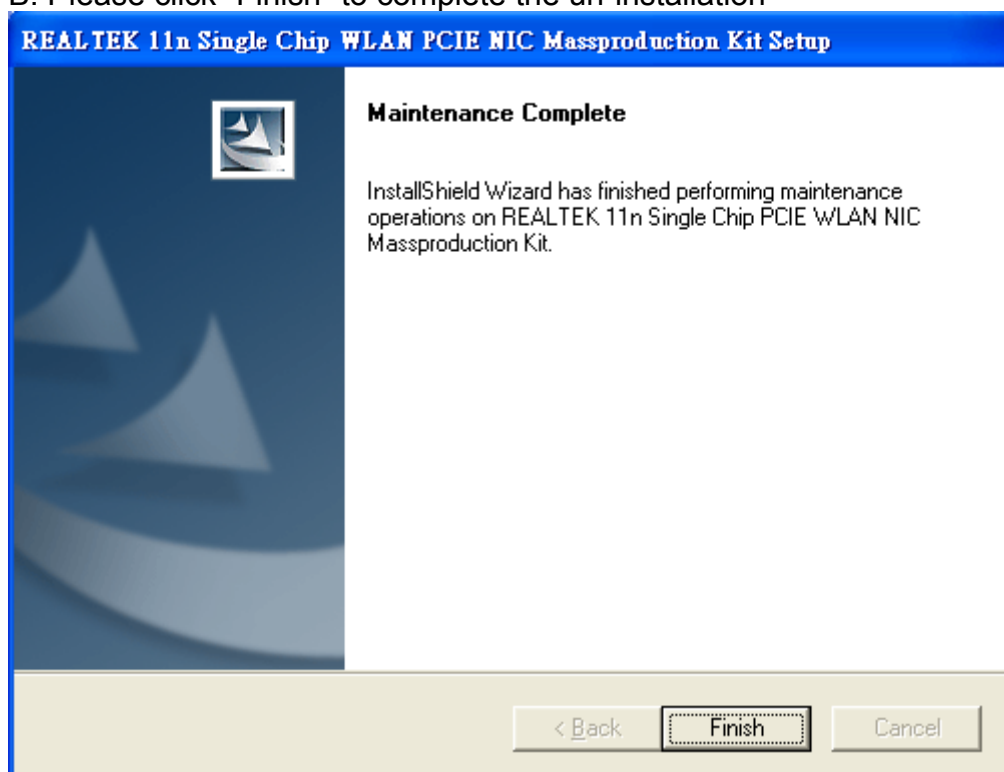

Realtek Semiconductor Corp.

Headquarters

No. 2, Innovation Road II, Hsinchu Science Park,

Hsinchu, 300, Taiwan, R.O.C.

Tel: 886-3-5780211 Fax: 886-3-5776047

www.realtek.com.tw