

# AP-110 Series Wireless Access Point

## Installation Guide

The Aruba AP-114 and AP-115 wireless access points support the IEEE 802.11n standard for high-performance WLAN. These access points use MIMO (Multiple-in, Multiple-out) technology and other high-throughput mode techniques to deliver high-performance, 802.11n 2.4 GHz and 5 GHz functionality while simultaneously supporting existing 802.11a/b/g wireless services. The AP-110 Series access points work only in conjunction with an Aruba Controller.

The Aruba AP-110 Series access point provides the following capabilities:

- Wireless transceiver
- Protocol-independent networking functionality
- IEEE 802.11a/b/g/n operation as a wireless access point
- IEEE 802.11a/b/g/n operation as a wireless air monitor
- Compatibility with IEEE 802.3at PoE+ and 802.3af PoE
- Central management configuration and upgrades through a controller



The AP-110 Series requires ArubaOS 6.3.1.0 or later.

### Package Contents

- AP-114 or AP-115 access point
- 9/16" and 15/16" Ceiling Rail Adapters
- Installation guide (this document)



Inform your supplier if there are any incorrect, missing, or damaged parts. If possible, retain the carton, including the original packing materials. Use these materials to repack and return the unit to the supplier if needed.

### AP-110 Series Hardware Overview

Figure 1 AP-110 Series LEDs

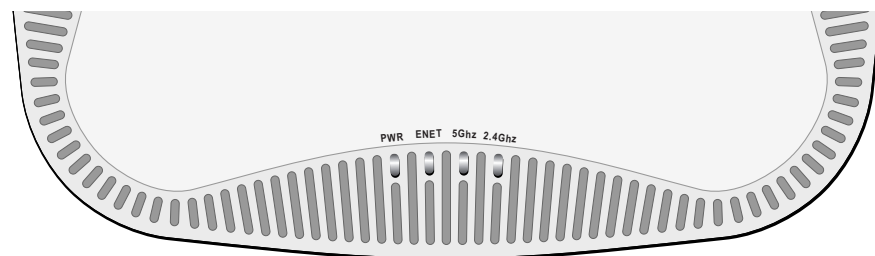

#### LEDs

The AP-110 Series is equipped with four LEDs that indicate the status of the various components of the AP.

- PWR: Indicates whether or not the AP-110 Series is powered-on
- ENET: Indicates the status of the AP-110 Series' Ethernet port
- 5 GHz: Indicates the status of the 802.11a/n radio
- 2.4 GHz: Indicates the status of the 802.11b/g/n radio

Table 1 AP-110 Series Series LED Meanings

LED	Color/State	Meaning
PWR	Off	No power to AP
	Red	Initial power-up
	Green - Flashing	AP booting
	Green - Steady	AP ready
ENET	Off	Ethernet link unavailable
	Yellow - Steady	10/100Mbps Ethernet link established
	Green - Steady	1000Mbps Ethernet link established
	Flashing	Ethernet link activity
5 GHz	Off	5 GHz radio disabled
	Yellow - Steady	5 GHz radio enabled in non-HT WLAN mode
	Green - Steady	5 GHz radio enabled in HT WLAN mode
	Flashing - Green	5 GHz Air or Spectrum Monitor
2.4 GHz	Off	2.4 GHz radio disabled
	Yellow - Steady	2.4 GHz radio enabled in non-HT WLAN mode
	Green - Steady	2.4 GHz radio enabled in HT WLAN mode
	Flashing - Green	2.4 GHz Air or Spectrum Monitor

Figure 2 AP-110 Series Side (AP-114 shown)

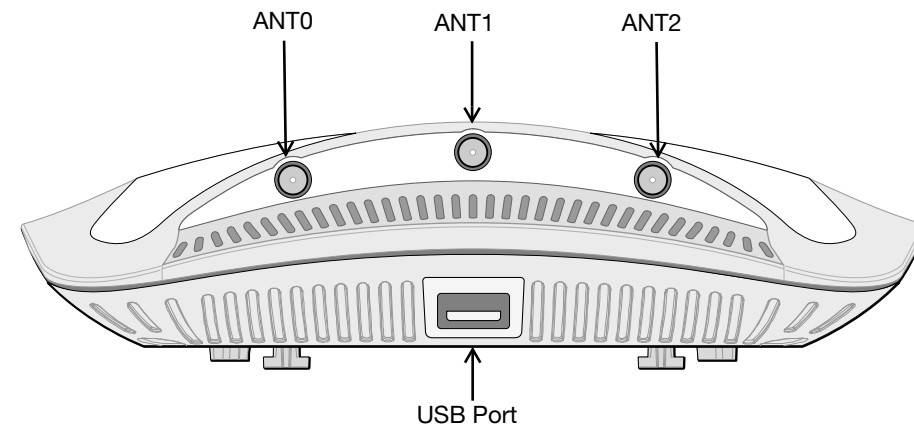

#### External Antenna Connectors

The AP-114 is equipped with three external antenna connectors. The connectors are labeled ANT0, ANT1, and ANT2, and correspond to radio chains 0, 1, and 2.

#### USB Interface

The AP-110 Series is equipped with a USB interface for connectivity with cellular modems.



The USB interface is disabled when the AP-110 Series is powered from 802.3af PoE.

Figure 3 AP-110 Series Rear

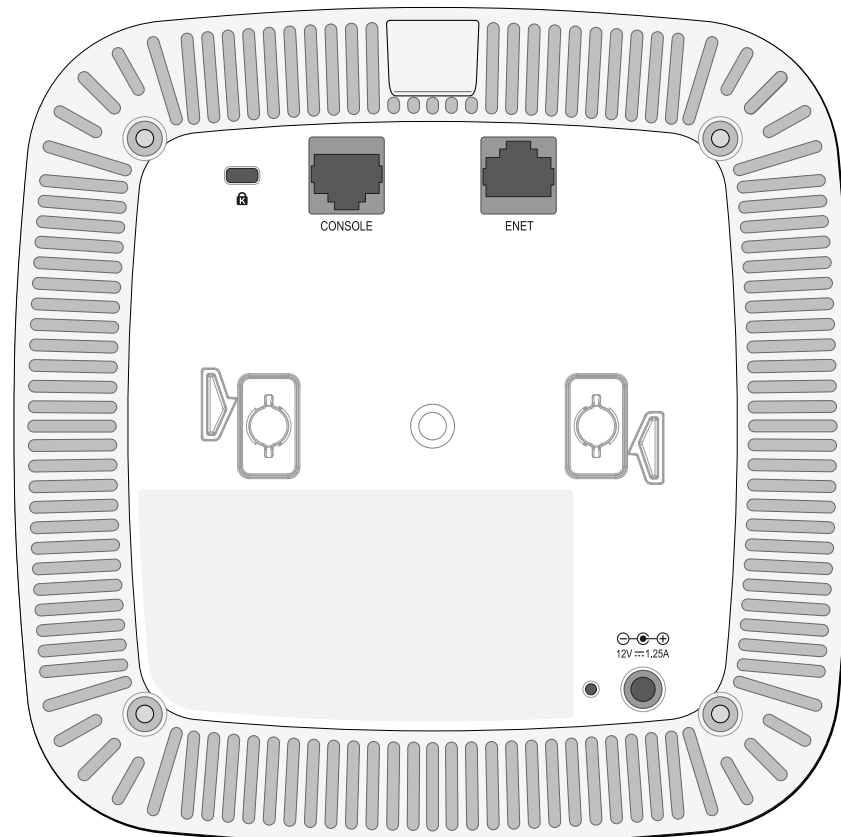

#### Console Port

The serial console port allows you to connect the AP to a serial terminal or a laptop for direct local management. This port is an RJ-45 female connector with the pinouts described in Figure 4. Connect it directly to a terminal or terminal server using an Ethernet cable.

Figure 4 Serial Port Pin-Out

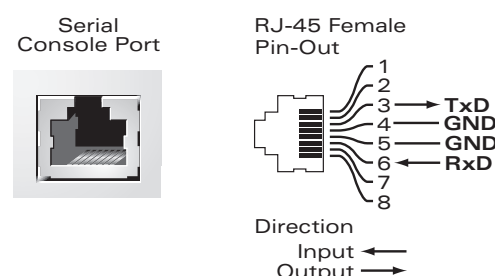

#### Ethernet Port

AP-110 Series is equipped with one 10/100/1000Base-T (RJ-45) auto-sensing, MDI/MDX wired-network connectivity port. This port supports IEEE 802.3af and 802.3at Power over Ethernet (PoE) compliance, accepting 48 VDC (nominal) as a standard defined Powered Device (PD) from a Power Sourcing Equipment (PSE) such as a PoE midspan injector, or network infrastructure that supports PoE.

The 10/100/1000 Mbps Ethernet ports are on the bottom of the AP. These ports have RJ-45 female connectors with the pin-outs shown in Figure 5.

Figure 5 Gigabit Ethernet Port Pin-Out

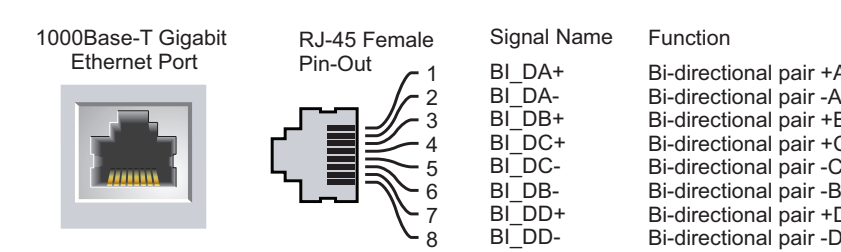

#### DC Power Socket

If PoE is not available, an optional Aruba AP AC-DC adapter kit (sold separately) can be used to power the AP-110 Series.

Additionally, a locally-sourced AC-to-DC adapter (or any DC source) can be used to power this device, as long as it complies with all applicable local regulatory requirements and the DC interface meets the following specifications:

- 12 VDC (+/- 5%)/18W
- Center-positive 1.7/4.0 mm circular plug, 9.5 mm length

#### Reset Button

The reset button can be used to return the AP to factory default settings. To reset the AP:

1. Power off the AP.
2. Press and hold the reset button using a small, narrow object, such as a paperclip.
3. Power-on the AP without releasing the reset button. The power LED will flash within 5 seconds.
4. Release the reset button.

The power LED will flash again within 15 seconds indicating that the reset is completed. The AP will now continue to boot with the factory default settings.

### Before You Begin



**FCC Statement:** Improper termination of access points installed in the United States configured to non-US model controllers will be in violation of the FCC grant of equipment authorization. Any such willful or intentional violation may result in a requirement by the FCC for immediate termination of operation and may be subject to forfeiture (47 CFR 1.80).

#### EU Statement:

Lower power radio LAN product operating in 2.4 GHz and 5 GHz bands. Please refer to the *ArubaOS User Guide* for details on restrictions.

Produit réseau local radio basse puissance operant dans la bande fréquence 2.4 GHz et 5 GHz. Merci de vous référer au *ArubaOS User Guide* pour les détails des restrictions.



Low Power FunkLAN Produkt, das im 2.4 GHz und im 5 GHz Band arbeitet. Weitere Informationen bezüglich Einschränkungen finden Sie im *ArubaOS User Guide*.

Apparati Radio LAN a bassa Potenza, operanti a 2.4 GHz e 5 GHz. Fare riferimento alla *ArubaOS User Guide* per avere informazioni dettagliate sulle restrizioni.

### Pre-Installation Network Requirements

After WLAN planning is complete and the appropriate products and their placement have been determined, the Aruba controller(s) must be installed and initial setup performed before the Aruba APs are deployed.

For initial setup of the controller, refer to the *ArubaOS Quick Start Guide* for the software version installed on your controller.

#### AP Pre-Installation Checklist

Before installing your AP-110 Series AP, ensure that you have the following:

- CAT5e or better UTP cable of required length
- One of the following power sources:
  - IEEE 802.3at or 802.3af-compliant Power over Ethernet (PoE) source. The POE source can be any power source equipment (PSE) controller or midspan PSE device
  - Aruba AP AC-DC adapter kit (sold separately)
- Aruba Controller provisioned on the network:
  - Layer 2/3 network connectivity to your access point
  - One of the following network services:
    - Aruba Discovery Protocol (ADP)
    - DNS server with an "A" record
    - DHCP Server with vendor-specific options

### Summary of the Setup Process

Successful setup of an AP-110 Series access point consists of five tasks, which must be performed in this order:

1. Verify pre-installation connectivity.
2. Identify the specific installation location for each AP.
3. Install each AP.
4. Verify post-installation connectivity.
5. Configure each AP.



Aruba Networks, Inc., in compliance with governmental requirements, has designed the AP-110 Series access points so that only authorized network administrators can change the settings. For more information about AP configuration, refer to the *ArubaOS Quick Start Guide* and *ArubaOS User Guide*.



Access points are radio transmission devices and as such are subject to governmental regulation. Network administrators responsible for the configuration and operation of access points must comply with local broadcast regulations. Specifically, access points must use channel assignments appropriate to the location in which the access point will be used.

### Verifying Pre-Installation Connectivity

Before you install APs in a network environment, make sure that the APs are able to locate and connect to the controller after power on.

Specifically, you must verify the following conditions:

- When connected to the network, each AP is assigned a valid IP address
- APs are able to locate the controller

Refer to the *ArubaOS Quick Start Guide* for instructions on locating and connecting to the controller.

### Identifying Specific Installation Locations

You can mount the AP-110 Series access point on a wall or on the ceiling. Use the AP placement map generated by Aruba's Airwave VisualRF Plan software application to determine the proper installation location(s). Each location should be as close as possible to the center of the intended coverage area and should be free from obstructions or obvious sources of interference. These RF absorbers/reflectors/interference sources will impact RF propagation and should have been accounted for during the planning phase and adjusted for in VisualRF plan.

### Identifying Known RF Absorbers/Reflectors/Interference Sources

Identifying known RF absorbers, reflectors, and interference sources while in the field during the installation phase is critical. Make sure that these sources are taken into consideration when you attach an AP to its fixed location. Examples of sources that degrade RF performance include:

- Cement and brick
- Objects that contain water
- Metal
- Microwave ovens
- Wireless phones and headsets

### Installing the AP



Service to all Aruba Networks products should be performed by trained service personnel only.

### Using the Ceiling Rail Adapter

The AP-110 Series ships with two ceiling rail adapters for 9/16" and 15/16" ceiling rails. Additional wall mount adapters and ceiling rail adapters for other rail styles are available as accessory kits.



Make sure the AP fits securely on the ceiling tile rail when hanging the device from the ceiling, because poor installation could cause it to fall onto people or equipment.

1. Pull the necessary cables through a prepared hole in the ceiling tile near where the AP will be placed.
2. Place the adapter against the back of the AP with the adapter at an angle of approximately 30 degrees to the tabs (see Figure 6).

- Twist the adapter clockwise until it snaps into place in the tabs (see Figure 6).

**Figure 6** Attaching the Ceiling Rail Adapter

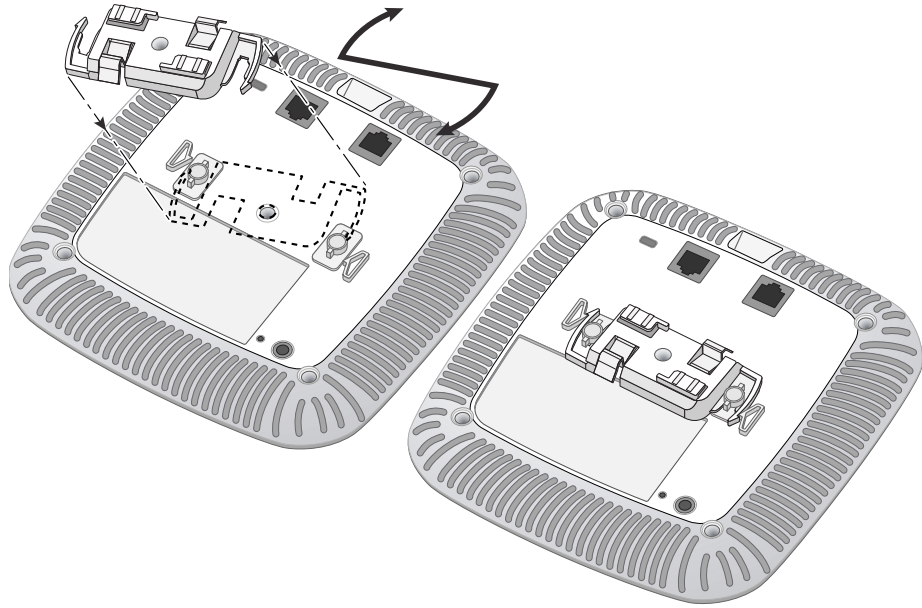

- If necessary, connect the console cable to the console port on the back of the AP.
- Hold the AP next to the ceiling tile rail with the ceiling tile rail mounting slots at approximately a 30-degree angle to the ceiling tile rail (see Figure 7). Make sure that any cable slack is above the ceiling tile.
- Pushing toward the ceiling tile, rotate the AP clockwise until the device clicks into place on the ceiling tile rail.

**Figure 7** Mounting the AP

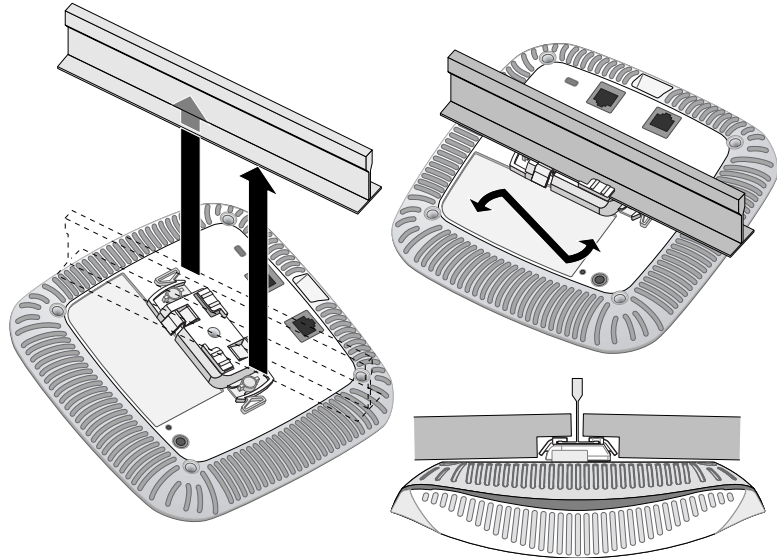

- On the AP-114, install the external antennas according to the manufacturer's instructions, and connect the antennas to the antenna interfaces on the AP.

## Connecting Required Cables

Install cables in accordance with all applicable local and national regulations and practices.

## Verifying Post-Installation Connectivity

The integrated LEDs on the AP can be used to verify that the AP is receiving power and initializing successfully (see Table 1). Refer to the *ArubaOS Quick Start Guide* for further details on verifying post-installation network connectivity.

## Configuring the AP-110 Series

### AP Provisioning/Reprovisioning

Provisioning parameters are unique to each AP. These local AP parameters are initially configured on the controller which are then pushed out to the AP and stored on the AP itself. Aruba recommends that provisioning settings be configured via the ArubaOS Web UI only. Refer to the *ArubaOS User Guide* for complete details.

### AP Configuration

Configuration parameters are network or controller specific and are configured and stored on the controller. Network configuration settings are pushed out to the AP(s) but remain stored on the controller.

Configuration settings can be configured via the ArubaOS Web UI or ArubaOS CLI. Refer to their respective guides for further details: the *ArubaOS User Guide*.

## Product Specifications

### Electrical

- Ethernet:
  - 1x 10/100/1000Base-T auto-sensing Ethernet RJ-45 Interface
  - MDI/MDX
  - IEEE 802.3 (10Base-T), IEEE 802.3u (100Base-T), IEEE 802.3ab (1000Base-T)
  - Power over Ethernet (IEEE 802.3at and 802.3af compliant), 48V DC (nominal) and 56V DC (maximum)/350mA (see Figure 5 for pin configuration)

- Power:
  - 12 VDC power interface, supports powering through an AC-to-DC power adapter
  - POE support on Ethernet ports: 802.3at-compliant and 802.3af-compliant POE sourcing devices



If a power adapter other than the one provided by Aruba Networks is used in the US or Canada, it should be cULus (NRTL) Listed, with an output rated 12 VDC, minimum 1.25A, marked "LPS" or "Class 2," and suitable for plugging into a standard power receptacle in the US and Canada.

For additional specifications on this product, please refer to the data sheet. The data sheet can be found at [www.arubanetworks.com](http://www.arubanetworks.com).

## Proper Disposal of Aruba Equipment

For the most current information about Global Environmental Compliance and Aruba products, see our website at [www.arubanetworks.com](http://www.arubanetworks.com).

### Waste of Electrical and Electronic Equipment

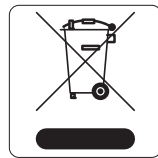

Aruba products at end of life are subject to separate collection and treatment in the EU Member States, Norway, and Switzerland and therefore are marked with the symbol shown at the left (crossed-out wheeled bin). The treatment applied at end of life of these products in these countries shall comply with the applicable national laws of countries implementing Directive 2002/96/EC on Waste of Electrical and Electronic Equipment (WEEE).

### European Union RoHS

Aruba products also comply with the EU Restriction of Hazardous Substances Directive 2011/65/EC (RoHS). EU RoHS restricts the use of specific hazardous materials in the manufacture of electrical and electronic equipment. Specifically, restricted materials under the RoHS Directive are Lead (including Solder used in printed circuit assemblies), Cadmium, Mercury, Hexavalent Chromium, and Bromine. Some Aruba products are subject to the exemptions listed in RoHS Directive Annex 7 (Lead in solder used in printed circuit assemblies). Products and packaging will be marked with the "RoHS" label shown at the left indicating conformance to this Directive.

### China RoHS



Aruba products also comply with China environmental declaration requirements and are labeled with the "EFUP 10" label shown at the left.

有害物质声明 Hazardous Materials Declaration						
零件名称 (Parts)	有害物质含量 (Hazardous Substances)					
	铅 (Pb)	汞 (Hg)	镉 (Cd)	六价铬 (Cr <sup>VI</sup> )	多溴联苯 (PBB)	多溴二苯醚 (PBDE)
电路板 (PC Boards)	X	0	0	0	0	0
机械组件 (Mechanical Sub-Assemblies)	X	0	0	0	0	0

0: 表示该有害物质在部件所有材料中的含量均在 SJ/T11363-2006 标准规定的限量要求以下。  
Indicates that the concentration of the hazardous substance in all homogeneous materials in the parts is below the relevant threshold of the SJ/T11363-2006 standard.

X: 表示该有害物质至少在该部件的某一均质材料中的含量超过 SJ/T11363-2006 标准规定的限量要求。  
Indicates that the concentration of the hazardous substance of at least one of all homogeneous materials in the parts is above the relevant threshold of the SJ/T11363-2006 standard.

对有害物质进行的产品, 本表显示, 供应商在产品中可能包含有害物质。  
This table shows where these substances may be found in the supply chain of electronic information products, as of the date of sale of the enclosed product.

此标志为针对零件及产品的环保使用标志。某些零件会有一个不同的环保使用期限, 请参见本标志的说明文件。  
此环保使用期限只适用于产品在产品手册中规定的条件下工作。  
The Environmentally Friendly Use Period (EFUP) for all enclosed products and their parts are per the symbol shown here. The Environmentally Friendly Use Period is valid only when the product is operated under the conditions defined in the product manual.

## Safety and Regulatory Compliance

Aruba Networks provides a multi-language document that contains country-specific restrictions and additional safety and regulatory information for all Aruba access points. This document can be viewed or downloaded from the following location: [www.arubanetworks.com/safety\\_addendum](http://www.arubanetworks.com/safety_addendum)

### Regulatory Model Names

The following regulatory model names apply to the AP-110 Series:

- AP-114: APIN0114
- AP-115: APIN0115

### FCC

This device is electronically labeled. To view the FCC ID:

- Log into the controller WebUI.
- Navigate to **Maintenance > Controller > About**.



**RF Radiation Exposure Statement:** This equipment complies with FCC RF radiation exposure limits. This equipment should be installed and operated with a minimum distance of 7.9 inches (20 cm) between the radiator and your body for 2.4 GHz and 5 GHz operations. This transmitter must not be co-located or operating in conjunction with any other antenna or transmitter. When operated in the 5.15 to 5.25 GHz frequency range, this device is restricted to indoor use to reduce the potential for harmful interference with co-channel Mobile Satellite Systems.



Users are advised that high power Radars are allocated as primary users of the bands 5250-5350 MHz and 5650-5850 MHz and these Radars could cause interference and/or damage to Licensed Exempt WLAN devices.

### FCC Class B Part 15

This device complies with Part 15 of the Federal Communications Commission (FCC) Rules. Operation is subject to the following two conditions:

- This device may not cause harmful interference.

- This device must accept any interference received, including interference that may cause undesired operation.



Changes or modifications to this unit not expressly approved by the party responsible for compliance could void the user's authority to operate this equipment.

This equipment has been tested and found to comply with the limits for a Class B digital device, pursuant to Part 15 of the FCC Rules. This equipment generates, uses and can radiate radio frequency energy and, if not installed and used in accordance with the manufacturer's instructions, may cause interference harmful to radio communications.

If this equipment does cause interference, which can be determined by turning the equipment off and on, the user is encouraged to try to correct the interference by one or more of the following measures:

- Reorient or relocate the receiving antenna.
- Increase the separation between the equipment and receiver.
- Connect the equipment to an outlet on a circuit different from that to which the receiver is connected.
- Consult the dealer or an experienced radio or TV technician for help.

Complies with the Class B limits for radio noise emissions as set out in the interference-causing equipment standard entitled "Digital Apparatus," ICES-003 of Industry Canada.

Cet appareil numérique de la classe B respecte toutes les exigences du Règlement sur le matériel brouilleur du Canada.



### EU Regulatory Conformance

This product is CE marked according to the provisions of the R & TTE Directive (1999/5/EC) - CE(1). Aruba Networks Inc., hereby declares that the APIN0114 / APIN0115 device models are in compliance with the essential requirements and other relevant provisions of Directive 1999/5/EC -CE(1)

The Declaration of Conformity made under Directive 1999/5/EC is available for viewing at the following location: <http://support.arubanetworks.com>

# AP-110 Series Wireless Access Point Installation Guide



## Contacting Aruba Networks

**Table 1**

Web Site Support	
Main Site	<a href="http://www.arubanetworks.com">http://www.arubanetworks.com</a>
Support Site	<a href="https://support.arubanetworks.com">https://support.arubanetworks.com</a>
Software Licensing Site	<a href="https://licensing.arubanetworks.com/login.php">https://licensing.arubanetworks.com/login.php</a>
Wireless Security Incident Response Team (WSIRT)	<a href="http://www.arubanetworks.com/support/wsirt.php">http://www.arubanetworks.com/support/wsirt.php</a>
Americas and APAC Support Email	<a href="mailto:support@arubanetworks.com">support@arubanetworks.com</a>
EMEA Support Email	<a href="mailto:emea.support@arubanetworks.com">emea.support@arubanetworks.com</a>
WSIRT Email Please email details of any security problem found in an Aruba product.	<a href="mailto:wsirt@arubanetworks.com">wsirt@arubanetworks.com</a>

**Table 2**

Telephone Support	
Aruba Corporate	+1 (408) 227-4500
FAX	+1 (408) 227-4550

## Copyright

© 2013 Aruba Networks, Inc. AirWave®, Aruba Networks®, Aruba Mobility Management System®, Blugscanner, For Wireless That Works®, Mobile Edge Architecture, People Move, Networks Must Follow®, RFPProtect®, The All Wireless Workplace Is Now Open For Business, and The Mobile Edge Company® are trademarks of Aruba Networks, Inc. All rights reserved. All other trademarks are the property of their respective owners.

## Open Source Code

Certain Aruba products include Open Source software code developed by third parties, including software code subject to the GNU General Public License ("GPL"), GNU Lesser General Public License ("LGPL"), or other Open Source Licenses. The Open Source code used can be found at this site: [http://www.arubanetworks.com/open\\_source](http://www.arubanetworks.com/open_source)

## Legal Notice

The use of Aruba Networks, Inc. switching platforms and software, by all individuals or corporations, to terminate other vendors' VPN client devices constitutes complete acceptance of liability by that individual or corporation for this action and indemnifies, in full, Aruba Networks, Inc. from any and all legal actions that might be taken against it with respect to infringement of copyright on behalf of those vendors.

## Warranty

This hardware product is protected by the standard Aruba warranty of one year parts/labor. For more information, refer to the ARUBAGARE SERVICE AND SUPPORT TERMS AND CONDITIONS.  
Altering this device (such as painting it) voids the warranty.



[www.arubanetworks.com](http://www.arubanetworks.com)  
1344 Crossman Avenue  
Sunnyvale, California 94089  
Phone: 408.227.4500  
Fax 408.227.4550

AP-110 Series Wireless Access Point | Installation Guide  
Part Number 0511365-02 | August 2013