



NBG6616

Simultaneous Dual-Band Wireless AC1200 Media Router

Version 1.00
Edition 1, 09/2014

User's Guide

Default Login Details

LAN IP Address	http://192.168.1.1 (Router Mode) http://192.168.1.2 (Access Point Mode)
Password	1234

IMPORTANT!

READ CAREFULLY BEFORE USE.

KEEP THIS GUIDE FOR FUTURE REFERENCE.

Screenshots and graphics in this book may differ slightly from your product due to differences in your product firmware or your computer operating system. Every effort has been made to ensure that the information in this manual is accurate.

Related Documentation

- Quick Start Guide

The Quick Start Guide shows how to connect the NBG6616 and access the Web Configurator wizards. It contains information on setting up your network and configuring for Internet access.

Contents Overview

User's Guide	11
Introduction	12
Introducing the Web Configurator	17
Connection Wizard	20
NBG6616 Modes	30
Easy Mode	31
Router Mode	42
Access Point Mode	49
Tutorials	56
Technical Reference	68
Monitor	69
WAN	74
Wireless LAN	84
LAN	107
DHCP Server	111
NAT	116
DDNS	126
Static Route	128
Firewall	131
Content Filtering	136
Parental Control	138
IPv6 Firewall	144
Bandwidth Management	147
Remote Management	154
Universal Plug-and-Play (UPnP)	158
USB Media Sharing	164
Maintenance	174
Troubleshooting	184

Table of Contents

Contents Overview	3
Table of Contents	4
Part I: User's Guide	11
Chapter 1	
Introduction.....	12
1.1 Overview	12
1.2 Applications	12
1.3 Ways to Manage the NBG6616	12
1.4 Good Habits for Managing the NBG6616	13
1.5 Resetting the NBG6616	13
1.5.1 How to Use the RESET Button	13
1.6 The WPS Button	13
1.7 LEDs	14
1.8 Wall Mounting	15
Chapter 2	
Introducing the Web Configurator	17
2.1 Overview	17
2.2 Accessing the Web Configurator	17
2.2.1 Login Screen	17
2.2.2 Password Screen	18
Chapter 3	
Connection Wizard	20
3.1 Overview	20
3.2 Accessing the Wizard	20
3.3 Connect to Internet	21
3.3.1 Connection Type: IPoE	22
3.3.2 Connection Type: PPPoE	24
3.4 Router Password	25
3.5 Wireless Security	26
3.5.1 Wireless Security: No Security	26
3.5.2 Wireless Security: WPA2-PSK	27

Chapter 4	
NBG6616 Modes	30
4.1 Overview	30
4.1.1 Web Configurator Modes	30
4.1.2 Device Modes	30
Chapter 5	
Easy Mode	31
5.1 Overview	31
5.2 What You Can Do	32
5.3 What You Need to Know	32
5.4 Navigation Panel	32
5.5 Network Map	33
5.6 Control Panel	34
5.6.1 Game Engine	35
5.6.2 Power Saving	35
5.6.3 Parental Control	36
5.6.4 Bandwidth MGMT	37
5.6.5 Firewall	38
5.6.6 Wireless Security	38
5.6.7 WPS	39
5.7 Status Screen in Easy Mode	40
Chapter 6	
Router Mode	42
6.1 Overview	42
6.2 Router Mode Status Screen	42
6.2.1 Navigation Panel	45
Chapter 7	
Access Point Mode	49
7.1 Overview	49
7.2 What You Can Do	49
7.3 What You Need to Know	49
7.3.1 Setting your NBG6616 to AP Mode	50
7.3.2 Accessing the Web Configurator in Access Point Mode	50
7.3.3 Configuring your WLAN and Maintenance Settings	51
7.4 AP Mode Status Screen	51
7.4.1 Navigation Panel	53
7.5 LAN Screen	53
Chapter 8	
Tutorials	56

8.1 Overview	56
8.2 Set Up a Wireless Network Using WPS	56
8.2.1 Push Button Configuration (PBC)	56
8.2.2 PIN Configuration	57
8.3 Connect to NBG6616 Wireless Network without WPS	58
8.3.1 Configure Your Notebook	60
8.4 Using Multiple SSIDs on the NBG6616	62
8.4.1 Configuring Security Settings of Multiple SSIDs	63

Part II: Technical Reference..... 68

**Chapter 9
Monitor..... 69**

9.1 Overview	69
9.2 What You Can Do	69
9.3 The Log Screen	69
9.3.1 View Log	69
9.4 DHCP Table	70
9.5 Packet Statistics	71
9.6 WLAN Station Status	72

**Chapter 10
WAN..... 74**

10.1 Overview	74
10.2 What You Can Do	74
10.3 What You Need To Know	74
10.3.1 Configuring Your Internet Connection	75
10.4 Internet Connection	76
10.4.1 IPoE Encapsulation	76
10.4.2 PPPoE Encapsulation	79
10.5 Advanced WAN Screen	82

**Chapter 11
Wireless LAN..... 84**

11.1 Overview	84
11.1.1 What You Can Do	85
11.1.2 What You Should Know	85
11.2 General Wireless LAN Screen	89
11.3 Wireless Security	91
11.3.1 No Security	91
11.3.2 WEP Encryption	92

11.3.3 WPA-PSK/WPA2-PSK	94
11.3.4 WPA/WPA2	95
11.4 More AP Screen	97
11.4.1 More AP Edit	98
11.5 MAC Filter Screen	100
11.6 Wireless LAN Advanced Screen	102
11.7 Quality of Service (QoS) Screen	102
11.8 WPS Screen	103
11.9 WPS Station Screen	105
11.10 Scheduling Screen	105
Chapter 12	
LAN	107
12.1 Overview	107
12.2 What You Can Do	107
12.3 What You Need To Know	107
12.3.1 IP Pool Setup	108
12.3.2 LAN TCP/IP	108
12.3.3 IP Alias	108
12.4 LAN IP Screen	108
12.5 IP Alias Screen	109
12.6 IPv6 LAN Screen	110
Chapter 13	
DHCP Server	111
13.1 Overview	111
13.1.1 What You Can Do	111
13.1.2 What You Need To Know	111
13.2 DHCP Server General Screen	111
13.3 DHCP Server Advanced Screen	112
13.4 DHCP Client List Screen	114
Chapter 14	
NAT.....	116
14.1 Overview	116
14.1.1 What You Can Do	116
14.1.2 What You Need To Know	117
14.2 General	118
14.3 Port Forwarding Screen	119
14.3.1 Port Forwarding Edit Screen	121
14.4 Port Trigger Screen	122
14.5 Technical Reference	123
14.5.1 NATPort Forwarding: Services and Port Numbers	123

14.5.2 NAT Port Forwarding Example	123
14.5.3 Trigger Port Forwarding	124
14.5.4 Trigger Port Forwarding Example	124
14.5.5 Two Points To Remember About Trigger Ports	125
Chapter 15	
DDNS.....	126
15.1 Overview	126
15.1.1 What You Need To Know	126
15.2 General	126
Chapter 16	
Static Route.....	128
16.1 Overview	128
16.2 IP Static Route Screen	128
16.2.1 Add/Edit Static Route	129
Chapter 17	
Firewall.....	131
17.1 Overview	131
17.1.1 What You Can Do	131
17.1.2 What You Need To Know	131
17.2 General Screen	133
17.3 Services Screen	133
Chapter 18	
Content Filtering.....	136
18.1 Overview	136
18.2 Content Filter	136
Chapter 19	
Parental Control.....	138
19.1 Overview	138
19.1.1 What You Need To Know	138
19.2 Parental Control Screen	138
19.2.1 Add/Edit a Parental Control Rule	139
19.2.2 Add/Edit a Service	141
19.3 Technical Reference	142
19.3.1 Customizing Keyword Blocking URL Checking	142
Chapter 20	
IPv6 Firewall.....	144
20.1 Overview	144

20.2 IPv6 Firewall Screen	144
Chapter 21	
Bandwidth Management.....	147
21.1 Overview	147
21.2 What You Can Do	147
21.3 What You Need To Know	148
21.4 General Screen	148
21.5 Advanced Screen	148
21.5.1 Rule Configuration: Application Rule Configuration	150
21.5.2 Rule Configuration: User Defined Service Rule Configuration	151
21.5.3 Predefined Bandwidth Management Services	153
Chapter 22	
Remote Management.....	154
22.1 Overview	154
22.2 What You Can Do in this Chapter	154
22.3 What You Need to Know	154
22.3.1 Remote Management and NAT	155
22.3.2 System Timeout	155
22.4 WWW Screen	155
22.5 Telnet Screen	156
22.6 Wake On LAN Screen	156
Chapter 23	
Universal Plug-and-Play (UPnP).....	158
23.1 Overview	158
23.2 What You Need to Know	158
23.2.1 NAT Traversal	158
23.2.2 Cautions with UPnP	158
23.3 UPnP Screen	159
23.4 Technical Reference	159
23.4.1 Using UPnP in Windows XP Example	159
23.4.2 Web Configurator Easy Access	161
Chapter 24	
USB Media Sharing.....	164
24.1 Overview	164
24.2 What You Can Do	165
24.3 What You Need To Know	165
24.4 Before You Begin	166
24.5 DLNA Screen	167
24.6 SAMBA Screen	167

24.7 FTP Screen	169
24.8 Example of Accessing Your Shared Files From a Computer	170
24.8.1 Use Windows Explorer to Share Files	170
24.8.2 Use FTP to Share Files	172
Chapter 25	
Maintenance	174
25.1 Overview	174
25.2 What You Can Do	174
25.3 General Screen	174
25.4 Password Screen	175
25.5 Time Setting Screen	176
25.6 Firmware Upgrade Screen	177
25.7 Configuration Backup/Restore Screen	179
25.8 Restart Screen	180
25.9 Language Screen	180
25.10 System Operation Mode Overview	181
25.11 Sys OP Mode Screen	182
Chapter 26	
Troubleshooting.....	184
26.1 Overview	184
26.2 Power, Hardware Connections, and LEDs	184
26.3 NBG6616 Access and Login	185
26.4 Internet Access	186
26.5 Resetting the NBG6616 to Its Factory Defaults	188
26.6 Wireless Connections	188
26.7 USB Device Problems	190
Appendix A Pop-up Windows, JavaScript and Java Permissions	191
Appendix B Setting Up Your Computer's IP Address	200
Appendix C Common Services.....	228
Appendix D Legal Information	231
Appendix E Customer Support	236
Index	242

PART I

User's Guide

Introduction

1.1 Overview

This chapter introduces the main features and applications of the NBG6616.

The NBG6616 extends the range of your existing wired network without additional wiring, providing easy network access to mobile users. You can set up a wireless network with other IEEE 802.11a/b/g/n/ac compatible devices. The NBG6616 is able to function both 2.4GHz and 5GHz networks at the same time.

A range of services such as a firewall and content filtering are also available for secure Internet computing.

There are two USB 2.0 ports on the side panel of your NBG6616. You can connect USB (version 2.0 or lower) memory sticks, USB hard drives, or USB devices for file sharing. The NBG6616 automatically detects the USB devices.

Note: For the USB function, it is strongly recommended to use version 2.0 or lower USB storage devices (such as memory sticks, USB hard drives) and/or USB devices. Other USB products are not guaranteed to function properly with the NBG6616.

1.2 Applications

You can have the following networks with the NBG6616:

- **Wired.** You can connect network devices via the Ethernet ports of the NBG6616 so that they can communicate with each other and access the Internet.
- **Wireless.** Wireless clients can connect to the NBG6616 to access network resources. You can use WPS (Wi-Fi Protected Setup) to create an instant network connection with another WPS-compatible device.
- **WAN.** Connect to a broadband modem/router for Internet access.

1.3 Ways to Manage the NBG6616

Use any of the following methods to manage the NBG6616.

- **WPS (Wi-Fi Protected Setup).** You can use the WPS button or the WPS section of the Web Configurator to set up a wireless network with your NBG6616.
- **Web Configurator.** This is recommended for everyday management of the NBG6616 using a (supported) web browser.

1.4 Good Habits for Managing the NBG6616

Do the following things regularly to make the NBG6616 more secure and to manage the NBG6616 more effectively.

- Change the password. Use a password that's not easy to guess and that consists of different types of characters, such as numbers and letters.
- Write down the password and put it in a safe place.
- Back up the configuration (and make sure you know how to restore it). Restoring an earlier working configuration may be useful if the device becomes unstable or even crashes. If you forget your password, you will have to reset the NBG6616 to its factory default settings. If you backed up an earlier configuration file, you would not have to totally re-configure the NBG6616. You could simply restore your last configuration.

1.5 Resetting the NBG6616

If you forget your password or IP address, or you cannot access the Web Configurator, you will need to use the **RESET** button at the back of the NBG6616 to reload the factory-default configuration file. This means that you will lose all configurations that you had previously saved, the password will be reset to "1234" and the IP address will be reset to "192.168.1.1".

1.5.1 How to Use the RESET Button

- 1 Make sure the power LED is on.
- 2 Press the **RESET** button for one to four seconds to restart/reboot the NBG6616.
- 3 Press the **RESET** button for longer than five seconds to set the NBG6616 back to its factory-default configurations.

1.6 The WPS Button

Your NBG6616 supports Wi-Fi Protected Setup (WPS), which is an easy way to set up a secure wireless network. WPS is an industry standard specification, defined by the Wi-Fi Alliance.

WPS allows you to quickly set up a wireless network with strong security, without having to configure security settings manually. Each WPS connection works between two devices. Both devices must support WPS (check each device's documentation to make sure).

Depending on the devices you have, you can either press a button (on the device itself, or in its configuration utility) or enter a PIN (a unique Personal Identification Number that allows one device to authenticate the other) in each of the two devices. When WPS is activated on a device, it has two minutes to find another device that also has WPS activated. Then, the two devices connect and set up a secure network by themselves.

You can use the WPS button () on the front panel of the NBG6616 to activate WPS in order to quickly set up a wireless network with strong security.

- 1 Make sure the power LED is on (not blinking).
- 2 Press the WPS button for more than three seconds and release it. Press the WPS button on another WPS-enabled device within range of the NBG6616.

Note: You must activate WPS in the NBG6616 and in another wireless device within two minutes of each other.

For more information on using WPS, see [Section 8.2 on page 56](#).

1.7 LEDs

Figure 1 Front Panel

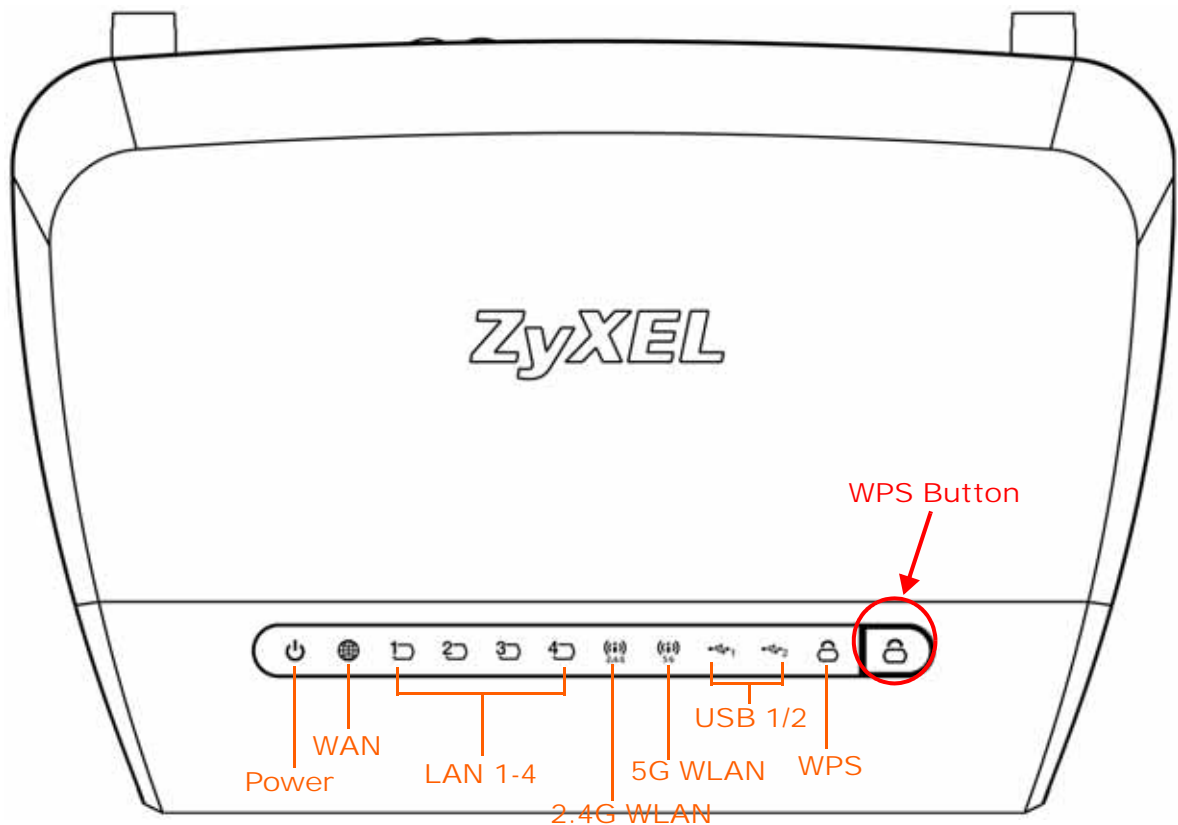

The following table describes the LEDs.

Table 1 Front panel LEDs

LED	COLOR	STATUS	DESCRIPTION
Power	Green	On	The NBG6616 is receiving power and functioning properly.
		Blinking	The NBG6616 is in the process of starting up or default restoring.
	Off	The NBG6616 is not receiving power.	

Table 1 Front panel LEDs (continued)

LED	COLOR	STATUS	DESCRIPTION
WAN	Green	On	The NBG6616's WAN connection is ready.
		Blinking	The NBG6616 is sending/receiving data through the WAN.
	Off		The WAN connection is not ready, or has failed.
LAN 1-4	Green	On	The NBG6616's LAN connection is ready.
		Blinking	The NBG6616 is sending/receiving data through the LAN.
	Off		The LAN connection is not ready, or has failed.
2.4G/5G WLAN	Green	On	The NBG6616 is ready and the 2.4GHz/5GHz wireless LAN is on, but is not sending/receiving data through the wireless LAN.
		Blinking	The NBG6616 is sending/receiving data through the wireless LAN.
	Off		The wireless LAN is not ready or has failed.
WPS	Green	On	WPS is enabled.
		Blinking	The NBG6616 is negotiating a WPS connection with a wireless client.
	Off		WPS is disabled.
USB 1/2	Green	On	The NBG6616 has a USB device installed.
		Blinking	The NBG6616 is transmitting and/or receiving data from routers through an installed USB device.
	Off		There is no USB device connected to the NBG6616.

1.8 Wall Mounting

You may need screw anchors if mounting on a concrete or brick wall.

Table 2 Wall Mounting Information

Distance between holes	13 cm
M4 Screws	Two
Screw anchors (optional)	Two

- 1 Select a position free of obstructions on a wall strong enough to hold the weight of the device.
- 2 Mark two holes on the wall at the appropriate distance apart for the screws.

Be careful to avoid damaging pipes or cables located inside the wall when drilling holes for the screws.

- 3 If using screw anchors, drill two holes for the screw anchors into the wall. Push the anchors into the full depth of the holes, then insert the screws into the anchors. Do not insert the screws all the way in - leave a small gap of about 0.5 cm.

If not using screw anchors, use a screwdriver to insert the screws into the wall. Do not insert the screws all the way in - leave a gap of about 0.5 cm.

- 4 Make sure the screws are fastened well enough to hold the weight of the NBG6616 with the connection cables.

- 5 Align the holes on the back of the NBG6616 with the screws on the wall. Hang the NBG6616 on the screws.

Figure 2 Wall Mounting Example

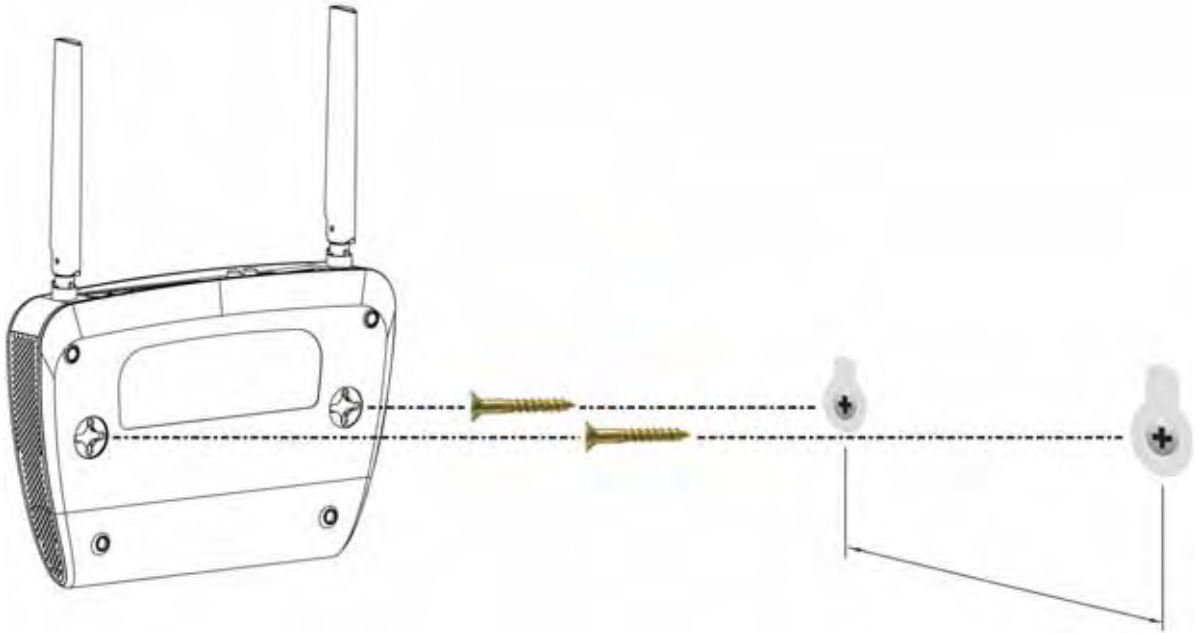

Introducing the Web Configurator

2.1 Overview

This chapter describes how to access the NBG6616 Web Configurator and provides an overview of its screens.

The Web Configurator is an HTML-based management interface that allows easy setup and management of the NBG6616 via Internet browser. Use Internet Explorer 9.0 and later versions, Mozilla Firefox 21 and later versions, Safari 6.0 and later versions or Google Chrome 26.0 and later versions. The recommended screen resolution is 1024 by 768 pixels.

In order to use the Web Configurator you need to allow:

- Web browser pop-up windows from your device. Web pop-up blocking is enabled by default in Windows XP SP (Service Pack) 2.
- JavaScript (enabled by default).
- Java permissions (enabled by default).

Refer to the Troubleshooting chapter ([Chapter 26 on page 184](#)) to see how to make sure these functions are allowed in Internet Explorer.

2.2 Accessing the Web Configurator

- 1 Make sure your NBG6616 hardware is properly connected and prepare your computer or computer network to connect to the NBG6616 (refer to the Quick Start Guide).
- 2 Launch your web browser.
- 3 The NBG6616 is in router mode by default. Type "http://192.168.1.1" as the website address. If the NBG6616 is in access point, the IP address is 192.168.1.2. See [Chapter 4 on page 30](#) for more information about the modes of the NBG6616.

Your computer must be in the same subnet in order to access this website address.

2.2.1 Login Screen

Note: If this is the first time you are accessing the Web Configurator, you may be redirected to the Wizard. Refer to [Chapter 3 on page 20](#) for the Connection Wizard screens.



The Web Configurator initially displays the following login screen.

Figure 3 Login screen



The following table describes the labels in this screen.

Table 3 Login screen

LABEL	DESCRIPTION
Language	Select the language you want to use to configure the Web Configurator.
Password	Type "1234" (default) as the password. Click Login .
	This shows the current weather, either in celsius or fahrenheit, of the city you specify in Section 2.2.2.1 on page 19 .
	This shows the time (hh:mm:ss) and date (yyyy:mm:dd) of the timezone you select in Section 25.5 on page 176 . The time is in 24-hour format, for example 15:00 is 3:00 PM.

2.2.2 Password Screen

You should see a screen asking you to change your password (highly recommended) as shown next.

Figure 4 Change Password Screen



The following table describes the labels in this screen.

Table 4 Change Password Screen

LABEL	DESCRIPTION
New Password	Type a new password.
Retype to Confirm	Retype the password for confirmation.
Apply	Click Apply to save your changes back to the NBG6616.
Ignore	Click Ignore if you do not want to change the password this time.

Note: The management session automatically times out when the time period set in the **Administrator Inactivity Timer** field expires (default five minutes; go to [Chapter 25 on page 174](#) to change this). Simply log back into the NBG6616 if this happens.

2.2.2.1 Weather Edit

You can change the temperature unit and select the location for which you want to know the weather.

Click the  icon to change the Weather display.

Figure 5 Change Weather



The following table describes the labels in this screen.

Table 5 Change Weather

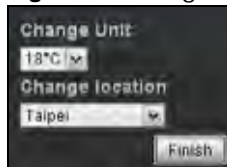
LABEL	DESCRIPTION
Change Unit	Choose which temperature unit you want the NBG6616 to display.
Change Location	Select the location for which you want to know the weather. If the city you want is not listed, choose one that is closest to it.
Finish	Click this to apply the settings and refresh the date and time display.

Connection Wizard

3.1 Overview

This chapter provides information on the wizard setup screens in the Web Configurator.

The Web Configurator's wizard setup helps you configure your device to access the Internet. Refer to your ISP for your Internet account information. Leave a field blank if you don't have that information.

3.2 Accessing the Wizard

Launch your web browser and type "http://192.168.1.1" as the website address. Type "1234" (default) as the password and click **Login**.

Note: The Wizard appears when the NBG6616 is accessed for the first time or when you reset the NBG6616 to its default factory settings.

The Wizard screen opens. Choose your **Language** and click **Connect to Internet**.

Figure 6 Welcome



3.3 Connect to Internet

The NBG6616 offers two Internet connection types. They are **IPoE** or **PPPoE**. The wizard attempts to detect which WAN connection type you are using.

Figure 7 Detecting your Internet Connection Type



If the wizard does not detect a connection type, you must select one from the drop-down list box. Check with your ISP to make sure you use the correct type.

Note: If you get an error message, check your hardware connections. Make sure your Internet connection is up and running.

The following screen depends on your Internet connection type. Enter the details provided by your Internet Service Provider (ISP) in the fields (if any).

Figure 8 Internet Connection Type



Your NBG6616 detects the following Internet Connection type.

Table 6 Internet Connection Type

CONNECTION TYPE	DESCRIPTION
IPoE	Select the IPoE (IP over Ethernet) option when the WAN port is used as a regular Ethernet.
PPPoE	Select the PPPoE (Point-to-Point Protocol over Ethernet) option for a dial-up connection.

3.3.1 Connection Type: IPoE

Choose **IPoE** as the **Internet Connection Type** when the WAN port is used as a regular Ethernet. Click **Next**.

Figure 9 Internet Connection Type: IPoE

The following table describes the labels in this screen.

Table 7 Internet Connection Type: IPoE

LABEL	DESCRIPTION
Internet Connection Type	Select the IPoE option.
Obtain an IP Address Automatically	Select this radio button if your ISP did not assign you a fixed IP address.
Static IP Address	Select this radio button if your ISP assigned an IP address for your Internet connection.
IP Address	Enter the IP address provided by your ISP.
Subnet Mask	Enter the IP subnet mask in this field.
Gateway IP Address	Enter the gateway IP address in this field.
First DNS Server Second DNS Server	Select Obtained From ISP if your ISP dynamically assigns DNS server information (and the NBG6616's WAN IP address). The field to the right displays the (read-only) DNS server IP address that the ISP assigns. Select User-Defined if you have the IP address of a DNS server. Enter the DNS server's IP address in the field to the right. Select None if you do not want to configure DNS servers. If you do not configure a DNS server, you must know the IP address of a computer in order to access it.
Exit	Click this to close the wizard screen without saving.
Back	Click this to return to the previous screen.
Next	Click this to continue.

Note: If you get an error screen after clicking **Next**, you might have selected the wrong Internet Connection type. Click **Back**, make sure your Internet connection is working and select the right Connection Type. Contact your ISP if you are not sure of your Internet Connection type.

3.3.2 Connection Type: PPPoE

Point-to-Point Protocol over Ethernet (PPPoE) functions as a dial-up connection. PPPoE is an IETF (Internet Engineering Task Force) standard specifying how a host personal computer interacts with a broadband modem (for example DSL, cable, wireless, etc.) to achieve access to high-speed data networks.

For the service provider, PPPoE offers an access and authentication method that works with existing access control systems (for instance, RADIUS).

One of the benefits of PPPoE is the ability to let end users access one of multiple network services, a function known as dynamic service selection. This enables the service provider to easily create and offer new IP services for specific users.

Operationally, PPPoE saves significant effort for both the subscriber and the ISP/carrier, as it requires no specific configuration of the broadband modem at the subscriber's site.

By implementing PPPoE directly on the NBG6616 (rather than individual computers), the computers on the LAN do not need PPPoE software installed, since the NBG6616 does that part of the task. Furthermore, with NAT, all of the LAN's computers will have Internet access.

Figure 10 Internet Connection Type: PPPoE



The following table describes the labels in this screen.

Table 8 Internet Connection Type: PPPoE

LABEL	DESCRIPTION
Internet Connection Type	Select the PPPoE option for a dial-up connection.
Get automatically from ISP	Select this radio button if your ISP did not assign you a fixed IP address.
Use Fixed IP Address	Select this radio button, provided by your ISP to give the NBG6616 a fixed, unique IP address.

Table 8 Internet Connection Type: PPPoE (continued)

LABEL	DESCRIPTION
PPP Username	Type the user name given to you by your ISP.
PPP Password	Type the password associated with the user name above.
My WAN IP Address	Type the name of your service provider.
Exit	Click this to close the wizard screen without saving.
Back	Click this to return to the previous screen.
Next	Click this to continue.

The NBG6616 connects to the Internet.

Figure 11 Connecting to the Internet

Note: If the Wizard successfully connects to the Internet, it proceeds to the next step. If you get an error message, go back to the previous screen and make sure you have entered the correct information provided by your ISP.

3.4 Router Password

Change the login password in the following screen. Enter the new password and retype it to confirm. Click **Next** to proceed with the **Wireless Security** screen.

Figure 12 Router Password



3.5 Wireless Security

Configure Wireless Settings. Configure the wireless network settings on your NBG6616 in the following screen. The fields that show up depend on the kind of security you select.

3.5.1 Wireless Security: No Security

Choose **No Security** in the Wireless Security screen to let wireless devices within range access your wireless network.

Figure 13 Wireless Security: No Security



The following table describes the labels in this screen.

Table 9 Wireless Security: No Security

LABEL	DESCRIPTION
Wireless Network Name (SSID)	Enter a descriptive name (up to 32 printable 7-bit ASCII characters) for the wireless LAN. Note: The setting here applies to both 2.4 GHz and 5 GHz wireless radios. If you change this field on the NBG6616, make sure all wireless stations use the same SSID in order to access the network.
Security Mode	Select a security level from the drop-down list box. Note: The setting here applies to both 2.4 GHz and 5 GHz wireless radios. Choose No Security to have no wireless LAN security configured. If you do not enable any wireless security on your NBG6616, your network is accessible to any wireless networking device that is within range.
Exit	Click this to close the wizard screen without saving.
Back	Click this to return to the previous screen.
Next	Click this to continue.

3.5.2 Wireless Security: WPA2-PSK

Choose **WPA2-PSK** security in the Wireless Security screen to set up a password for your wireless network.

Figure 14 Wireless Security: WPA2-PSK



The following table describes the labels in this screen.

Table 10 Wireless Security: WPA2-PSK

LABEL	DESCRIPTION
Wireless Network Name (SSID)	Enter a descriptive name (up to 32 printable 7-bit ASCII characters) for the wireless LAN. Note: The setting here applies to both 2.4 GHz and 5 GHz wireless radios. If you change this field on the NBG6616, make sure all wireless stations use the same SSID in order to access the network.
Security Mode	Select a security level from the drop-down list box. Note: The setting here applies to both 2.4 GHz and 5 GHz wireless radios. Choose WPA2-PSK security to configure a Pre-Shared Key. Choose this option only if your wireless clients support WPA2-PSK.
Wireless password	Type from 8 to 63 case-sensitive ASCII characters. You can set up the most secure wireless connection by configuring WPA in the wireless LAN screens.
Verify Password	Retype the password to confirm.
Exit	Click this to close the wizard screen without saving.
Back	Click this to return to the previous screen.
Next	Click this to continue.

Congratulations! Open a web browser, such as Internet Explorer, to visit your favorite website.

Note: If you cannot access the Internet when your computer is connected to one of the NBG6616's LAN ports, check your connections. Then turn the NBG6616 off, wait for a few seconds then turn it back on. If that does not work, log in to the web configurator again and check you have typed all information correctly. See the User's Guide for more suggestions.

Figure 15 Congratulations



You can also click **GO** to open the **Easy Mode** Web Configurator of your NBG6616.

You have successfully set up your NBG6616 to operate on your network and access the Internet. You are now ready to connect wirelessly to your NBG6616 and access the Internet.

NBG6616 Modes

4.1 Overview

This chapter introduces the different modes available on your NBG6616. First, the term “mode” refers to two things in this User’s Guide.

- **Web Configurator mode.** This refers to the Web Configurator interface you want to use for editing NBG6616 features.
- **Device mode.** This is the operating mode of your NBG6616, or simply how the NBG6616 is being used in the network.

4.1.1 Web Configurator Modes

This refers to the configuration interface of the Web Configurator, which has two modes:

- **Easy:** The Web Configurator shows this mode by default. Refer to [Chapter 5 on page 31](#) for more information on the screens in this mode. This interface may be sufficient for users who just want to use the device.
- **Expert:** Advanced users can change to this mode to customize all the functions of the NBG6616. Click **Expert Mode** after logging into the Web Configurator. The User’s Guide [Chapter 2 on page 17](#) through [Chapter 25 on page 182](#) discusses the screens in this mode.

4.1.2 Device Modes

This refers to the operating mode of the NBG6616, which can act as a:

- **Router:** This is the default device mode of the NBG6616. Use this mode to connect the local network to another network, like the Internet. Go to [Section 6.2 on page 42](#) to view the **Status** screen in this mode.
- **Access Point:** Use this mode if you want to extend your network by allowing network devices to connect to the NBG6616 wirelessly. Go to [Section 7.4 on page 51](#) to view the **Status** screen in this mode.

For more information on these modes and to change the mode of your NBG6616, refer to [Chapter 25 on page 182](#).

The menu for changing device modes is available in **Expert Mode** only.

Note: Choose your device mode carefully to avoid having to change it later.

When changing to another mode, the IP address of the NBG6616 changes. The running applications and services of the network devices connected to the NBG6616 can be interrupted.

Easy Mode

5.1 Overview

The Web Configurator is set to **Easy Mode** by default. You can configure several key features of the NBG6616 in this mode. This mode is useful for users who are not fully familiar with some features that are usually intended for network administrators.

When you log in to the Web Configurator, the following screen opens.

Figure 16 Easy Mode: Network Map

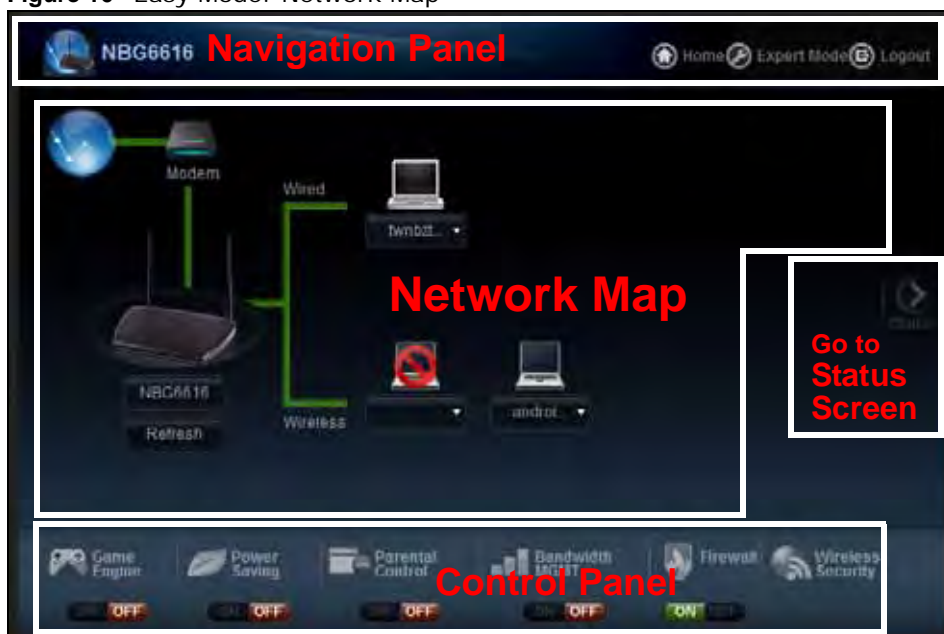

Click **Status** to open the following screen.

Figure 17 Easy Mode: Status Screen



5.2 What You Can Do

You can do the following in this mode:

- Use this **Navigation Panel** to opt out of the **Easy** mode ([Section 5.4 on page 32](#)).
- Use the **Network Map** screen to check if your NBG6616 can ping the gateway and whether it is connected to the Internet ([Section 5.5 on page 33](#)).
- Use the **Control Panel** to configure and enable NBG6616 features, including wireless security, wireless scheduling and bandwidth management and so on ([Section 5.6 on page 34](#)).
- Use the **Status Screen** to view read-only information about the NBG6616, including the WAN IP, MAC address of the NBG6616 and the firmware version ([Section 5.7 on page 40](#)).

5.3 What You Need to Know

Between the different device modes, the **Control Panel** ([Section 5.6 on page 34](#)) changes depending on which features are applicable to the mode:

- **Router Mode:** All **Control Panel** features are available.
- **Access Point Mode:** Only **Power Saving** and **Wireless Security** are available.

5.4 Navigation Panel

Use this navigation panel to opt out of the **Easy** mode.

Figure 18 Control Panel

The following table describes the labels in this screen.

Table 11 Control Panel

ITEM	DESCRIPTION
Home	Click this to go to the Login page.
Expert Mode	Click this to change to Expert Mode and customize features of the NBG6616.
Logout	Click this to end the Web Configurator session.

5.5 Network Map

Note: The Network MAP is viewable by Windows XP (need to install patch), Windows Vista and Windows 7 users only. For Windows XP (Service Pack 2) users, you can see the network devices connected to the NBG6616 by downloading the LLTD (Link Layer Topology Discovery) patch from the Microsoft Website.

Note: Don't worry if the Network Map does not display in your web browser. This feature may not be supported by your system. You can still configure the Control Panel ([Section 5.6 on page 34](#)) in the Easy Mode and the NBG6616 features that you want to use in the Expert Mode.

When you log into the Web Configurator, the Network Map is shown as follows.

Figure 19 Network Map

The line connecting the NBG6616 to the gateway becomes green when the NBG6616 is able to ping the gateway. It becomes red when the ping initiating from the NBG6616 does not get a response from the gateway. The same rule applies to the line connecting the gateway to the Internet.

You can also view the devices (represented by icons indicating the kind of network device, such as android device, apple device or Windows OS) connected to the NBG6616, including those connecting wirelessly. Click the **Refresh** button or right-click on the NBG6616 icon to refresh the network map and go to the Wizard. Click on a device icon and select to view information about the device, block or allow the device's access to the NBG6616, or view the parental control rules.

5.6 Control Panel

The features configurable in **Easy Mode** are shown in the **Control Panel**.

Figure 20 Control Panel

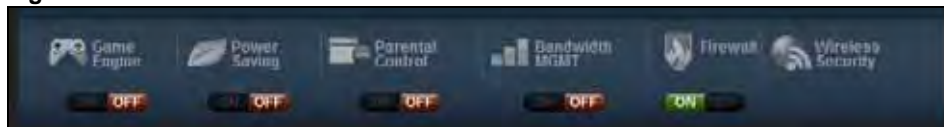

Switch **ON** to enable the feature. Otherwise, switch **OFF**. If the feature is turned on, the green light flashes. If it is turned off, the red light flashes.

Additionally, click the feature to open a screen where you can edit its settings.

The following table describes the labels in this screen.

Table 12 Control Panel

ITEM	DESCRIPTION
Game Engine	Switch ON to maximize bandwidth for gaming traffic in your network. Otherwise, switch OFF . Refer to Section 5.6.1 on page 35 to see this screen.
Power Saving	Click this to schedule the wireless feature of the NBG6616. Disabling the wireless function helps lower the energy consumption of the NBG6616. Switch ON to apply wireless scheduling. Otherwise, switch OFF . Refer to Section 5.6.2 on page 35 to see this screen.
Parental Control	Click this to restrict access to certain websites, based on keywords contained in URLs, to which you do not want users in your network to open. Switch ON to apply website filtering. Otherwise, switch OFF . Refer to Section 5.6.3 on page 36 to see this screen.
Bandwidth MGMT	Click this to edit bandwidth management for predefined applications. Switch ON to have the NBG6616 management bandwidth for uplink and downlink traffic according to an application or service. Otherwise, switch OFF . Refer to Section 5.6.4 on page 37 to see this screen.

Table 12 Control Panel (continued)

ITEM	DESCRIPTION
Firewall	Switch ON to ensure that your network is protected from Denial of Service (DoS) attacks. Otherwise, switch OFF . Refer to Section 5.6.5 on page 38 to see this screen.
Wireless Security	Click this to configure the wireless security, such as SSID, security mode and WPS key on your NBG6616. Refer to Section 5.6.6 on page 38 to see this screen.

5.6.1 Game Engine

When this feature is enabled, the NBG6616 maximizes the bandwidth for gaming traffic that it forwards out through an interface.

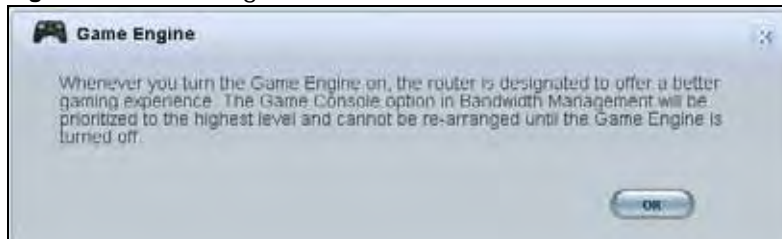
Figure 21 Game Engine

Note: When this is switched on, the **Game Console** tab in the **Bandwidth Mgmt** screen is automatically positioned on top.

Turn this off if your network is not using gaming.

Click **OK** to close this screen.

5.6.2 Power Saving

Use this screen to set the day of the week and time of the day when your wireless LAN is turned on and off. Wireless LAN scheduling is disabled by default.

Disabling the wireless capability lowers the energy consumption of the of the NBG6616.

Figure 22 Power Saving

The following table describes the labels in this screen.

Table 13 Power Saving

LABEL	DESCRIPTION
Wireless Radio	Choose whether you want to apply the power saving schedule to 2.4G Hz or 5G Hz wireless radio.
WLAN Status	Select On or Off to specify whether the Wireless LAN is turned on or off (depending on what you selected in the WLAN Status field). This field works in conjunction with the Day and For the following times fields.
Day	Select Everyday or the specific days to turn the Wireless LAN on or off. If you select Everyday you can not select any specific days. This field works in conjunction with the For the following times field.
For the following times (24-Hour Format)	Select a begin time using the first set of hour and minute (min) drop down boxes and select an end time using the second set of hour and minute (min) drop down boxes. If you have chosen On earlier for the WLAN Status the Wireless LAN will turn on between the two times you enter in these fields. If you have chosen Off earlier for the WLAN Status the Wireless LAN will turn off between the two times you enter in these fields. In this time format, midnight is 00:00 and progresses up to 24:00. For example, 6:00 PM is 18:00.
Apply	Click Apply to save your changes back to the NBG6616.
Cancel	Click Cancel to close this screen without saving any changes.

5.6.3 Parental Control

Use this screen to view the parental control rules configured on the NBG6616. See [Chapter 19 on page 138](#) for how to enable and configure parental control rules.

Figure 23 Parental Control

The following table describes the labels in this screen.

Table 14 Parental Control

LABEL	DESCRIPTION
Status	This indicates whether the rule is active or not. A yellow bulb signifies that this rule is active. A gray bulb signifies that this rule is not active.
Network User (MAC)	This shows the MAC address of the LAN user's computer to which this rule applies.
Internet Access Schedule	This shows the day(s) and time when parental controls are enabled.
Network Service	This shows whether the network service is configured. If not, NONE will be shown.
Website Blocked	This shows whether the website block is configured. If not, NONE will be shown.

5.6.4 Bandwidth MGMT

Use this screen to set bandwidth allocation to pre-defined services and applications for bandwidth allocation.

The NBG6616 uses bandwidth management for incoming and outgoing traffic. Rank the services and applications by dragging them accordingly from **High** to **Low** and click **Apply**. Click **Cancel** to close the screen.

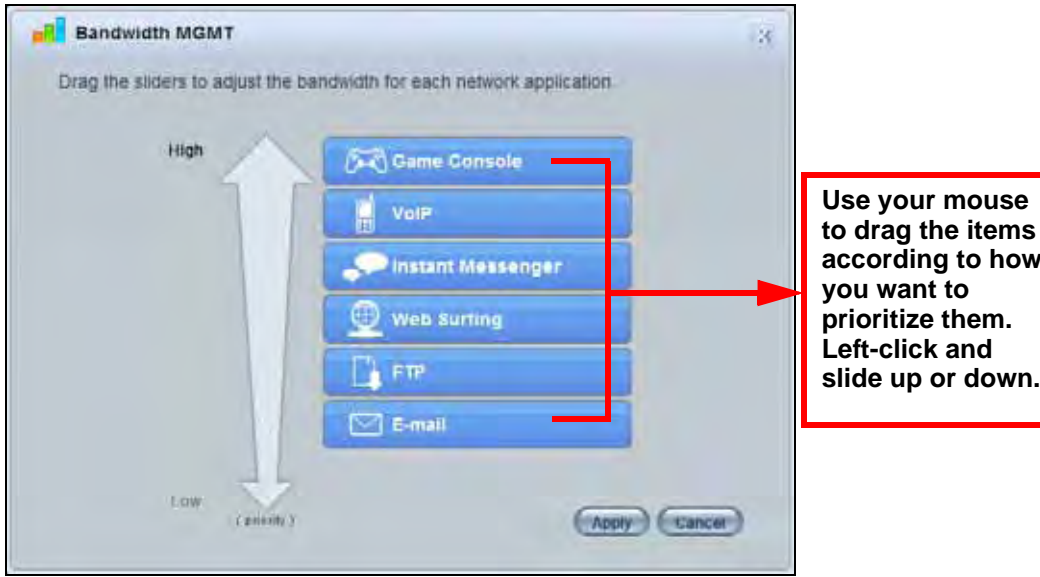
Figure 24 Bandwidth MGNT

5.6.5 Firewall

Enable this feature to protect the network from Denial of Service (DoS) attacks. The NBG6616 blocks repetitive pings from the WAN that can otherwise cause systems to slow down or hang. See [Chapter 17 on page 131](#) for how to enable and configure firewall rules.

Figure 25 Firewall

Click **OK** to close this screen.

5.6.6 Wireless Security

Use this screen to configure security for your the wireless LAN. You can enter the SSID and select the wireless security mode in the following screen.

Note: You can enable the wireless function of your NBG6616 by first turning on the switch in the back panel.

Figure 26 Wireless Security



The following table describes the general wireless LAN labels in this screen.

Table 15 Wireless Security

LABEL	DESCRIPTION
Wireless Radio	Choose whether you want to apply the wireless security to 2.4G Hz or 5G Hz wireless radio.
Wireless Network Name (SSID)	(Service Set IDentity) The SSID identifies the Service Set with which a wireless station is associated. Wireless stations associating to the access point (AP) must have the same SSID. Enter a descriptive name (up to 32 keyboard characters) for the wireless LAN.
Security mode	Select WPA2-PSK to add security on this wireless network. The wireless clients which want to associate to this network must have same wireless security settings as this device. After you select to use a security, additional options appears in this screen. Select No Security to allow any client to connect to this network without authentication.
Wireless password	This field appears when you choose wither WPA2-PSK as the security mode. Type a pre-shared key from 8 to 63 case-sensitive keyboard characters.
Verify password	Type the password again to confirm.
Apply	Click Apply to save your changes back to the NBG6616.
Cancel	Click Cancel to close this screen.
WPS	Click this to configure the WPS screen. You can transfer the wireless settings configured here (Wireless Security screen) to another wireless device that supports WPS.

5.6.7 WPS

Use this screen to add a wireless station to the network using WPS. Click **WPS** in the **Wireless Security** to open the following screen.

Figure 27 Wireless Security: WPS



The following table describes the labels in this screen.

Table 16 Wireless Security: WPS

LABEL	DESCRIPTION
Wireless Security	Click this to go back to the Wireless Security screen.
WPS	<p>Create a secure wireless network simply by pressing a button.</p> <p>The NBG6616 scans for a WPS-enabled device within the range and performs wireless security information synchronization.</p> <p>Note: After you click the WPS button on this screen, you have to press a similar button in the wireless station utility within 2 minutes. To add the second wireless station, you have to press these buttons on both device and the wireless station again after the first 2 minutes.</p>
Register	<p>Create a secure wireless network simply by entering a wireless client's PIN (Personal Identification Number) in the NBG6616's interface and pushing this button.</p> <p>Type the same PIN number generated in the wireless station's utility. Then click Register to associate to each other and perform the wireless security information synchronization.</p>
Exit	Click Exit to close this screen.

5.7 Status Screen in Easy Mode

In the Network Map screen, click **Status** to view read-only information about the NBG6616.

Figure 28 Status Screen in Easy Mode

The following table describes the labels in this screen.

Table 17 Status Screen in Easy Mode

ITEM	DESCRIPTION
Name	This is the name of the NBG6616 in the network. You can change this in the Maintenance > General screen in Section 25.3 on page 174 .
Time	This is the current system date and time. The date is in YYYY:MM:DD (Year-Month-Day) format. The time is in HH:MM:SS (Hour:Minutes:Seconds) format.
WAN IP	This is the IP address of the WAN port.
MAC Address	This is the MAC address of the NBG6616.
Firmware Version	This shows the firmware version of the NBG6616. The firmware version format shows the trunk version, model code and release number.
Wireless 2.4G Network Name (SSID)	This shows the SSID of the wireless network. You can configure this in the Wireless Security screen (Section 5.6.6 on page 38 ; Section 11.2 on page 89).
Wireless 5G Network Name (SSID)	
Security	This shows the wireless security used by the NBG6616.

Router Mode

6.1 Overview

The NBG6616 is set to router mode by default. Routers are used to connect the local network to another network (for example, the Internet). In the figure below, the NBG6616 connects the local network (**LAN1** ~ **LAN4**) to the Internet.

Figure 29 NBG6616 Network

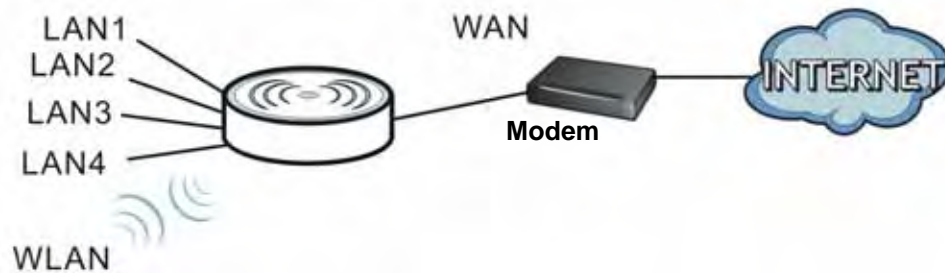

Note: The **Status** screen is shown after changing to the **Expert Mode** of the Web Configurator. It varies depending on the device mode of your NBG6616.

6.2 Router Mode Status Screen

Click  to open the status screen.

Figure 30 Status Screen: Router Mode

The screenshot shows the ZyXEL NBG6616 Status screen. At the top, there is a navigation bar with 'Logout' and 'About' links, and an 'Easy Mode' button. Below the navigation bar, there is a 'Refresh Interval' dropdown menu set to 'None' and a 'Refresh Now' button. The main content area is divided into several sections:





- Device Information:** A table with columns 'Item' and 'Data'. It lists Host Name (NBG6616), Model Number (NBG6616), Firmware Version (V1.00(AAR0-0)B1), Sys OP Mode (ROUTER Mode), WAN Information (MAC Address: 00AA:BB:CC:DD:03, IP Address, IP Subnet Mask, Default Gateway, IPv6 Address), LAN Information (MAC Address: 00AA:BB:CC:DD:02, IP Address: 192.168.1.1, IP Subnet Mask: 255.255.255.0, DHCP: Server, IPv6 Address), WLAN 2.4G Information (WLAN OP Mode: Access Point Mode, MAC Address: 00AA:BB:CC:DD:00, SSID: ZYXELCCDD00, Channel: 6, Security: WPA2-PSK), WLAN 5G Information (MAC Address: 00AA:BB:CC:DD:01, SSID: ZYXELCCDD00, Channel: 140, Security: WPA2-PSK), and Firewall (Enable).
- System Status:** A table with columns 'Item' and 'Data'. It lists System Up Time (0day 0hr19min 45sec), Current Date/Time (2014-03-24/02:15:41), System Resource (CPU Usage: 0%, Memory Usage: 19%), and Interface Status.
- Interface Status:** A table with columns 'Interface', 'Status', and 'Rate'. It lists WAN (Down), LAN1 (Down), LAN2 (Down), LAN3 (Down), LAN4 (Down), WLAN 2.4G (UP, 450M), and WLAN 5G (UP, 1.3G).
- Summary:** A section with links for Packet Statistics (Details...), WLAN 2.4G Station Status (Details...), and WLAN 5G Station Status (Details...).

The following table describes the icons shown in the **Status** screen.

Table 18 Status Screen Icon Key

ICON	DESCRIPTION
	Click this at any time to exit the Web Configurator.
	Click this icon to view copyright and a link for related product information.
	Click this icon to go to Easy Mode. See Chapter 5 on page 31 .
	Select a number of seconds or None from the drop-down list box to refresh all screen statistics automatically at the end of every time interval or to not refresh the screen statistics.
	Click this button to refresh the status screen statistics.

Table 18 Status Screen Icon Key (continued)

ICON	DESCRIPTION
	Click this icon to see the Status page. The information in this screen depends on the device mode you select.
	Click this icon to see the Monitor navigation menu.
	Click this icon to see the Configuration navigation menu.
	Click this icon to see the Maintenance navigation menu.

The following table describes the labels shown in the **Status** screen.

Table 19 Status Screen: Router Mode

LABEL	DESCRIPTION
Device Information	
Host Name	This is the System Name you enter in the Maintenance > General screen. It is for identification purposes.
Model Number	This is the model name of your device.
Firmware Version	This is the firmware version and the date created.
Sys OP Mode	This is the device mode (Section 4.1.2 on page 30) to which the NBG6616 is set - Router Mode .
WAN Information	
MAC Address	This shows the WAN Ethernet adapter MAC Address of your device.
IP Address	This shows the WAN port's IP address.
IP Subnet Mask	This shows the WAN port's subnet mask.
Default Gateway	This shows the WAN port's gateway IP address.
IPv6 Address	This shows the IPv6 address of the NBG6616 on the WAN.
LAN Information	
MAC Address	This shows the LAN Ethernet adapter MAC Address of your device.
IP Address	This shows the LAN port's IP address.
IP Subnet Mask	This shows the LAN port's subnet mask.
DHCP	This shows the LAN port's DHCP role - Server or Disable .
IPv6 Address	This shows the IPv6 address of the NBG6616 on the LAN.
WLAN 2.4G Information	
WLAN OP Mode	This is the device mode (Section 4.1.2 on page 30) to which the NBG6616's wireless LAN is set - Access Point Mode .
MAC Address	This shows the 2.4GHz wireless adapter MAC Address of your device.
SSID	This shows a descriptive name used to identify the NBG6616 in the 2.4GHz wireless LAN.
Channel	This shows the channel number which you select manually.
Security	This shows the level of wireless security the NBG6616 is using.
WLAN 5G Information	
MAC Address	This shows the 5GHz wireless adapter MAC Address of your device.
SSID	This shows a descriptive name used to identify the NBG6616 in the 5GHz wireless LAN.
Channel	This shows the channel number which you select manually.
Security	This shows the level of wireless security the NBG6616 is using.

Table 19 Status Screen: Router Mode (continued)

LABEL	DESCRIPTION
Firewall	This shows whether the firewall is enabled or not.
Summary	
Packet Statistics	Click Details... to go to the Monitor > Packet Statistics screen (Section 9.5 on page 71). Use this screen to view port status and packet specific statistics.
WLAN 2.4G Station Status	Click Details... to go to the Monitor > WLAN 2.4G Station Status screen (Section 9.6 on page 72). Use this screen to view the wireless stations that are currently associated to the NBG6616's 2.4GHz wireless LAN.
WLAN 5G Station Status	Click Details... to go to the Monitor > WLAN 5G Station Status screen (Section 9.6 on page 72). Use this screen to view the wireless stations that are currently associated to the NBG6616's 5GHz wireless LAN.
System Status	
Item	This column shows the type of data the NBG6616 is recording.
Data	This column shows the actual data recorded by the NBG6616.
System Up Time	This is the total time the NBG6616 has been on.
Current Date/Time	This field displays your NBG6616's present date and time.
System Resource	
- CPU Usage	This displays what percentage of the NBG6616's processing ability is currently used. When this percentage is close to 100%, the NBG6616 is running at full load, and the throughput is not going to improve anymore. If you want some applications to have more throughput, you should turn off other applications (for example, using bandwidth management.)
- Memory Usage	This shows what percentage of the heap memory the NBG6616 is using.
Interface Status	
Interface	This displays the NBG6616 port types. The port types are: WAN , LAN and WLAN .
Status	For the LAN and WAN ports, this field displays Down (line is down) or Up (line is up or connected). For the 2.4GHz/5GHz WLAN, it displays Up when the 2.4GHz/5GHz WLAN is enabled or Down when the 2.4G/5G WLAN is disabled.
Rate	For the LAN ports, this displays the port speed and duplex setting or N/A when the line is disconnected. For the WAN port, it displays the port speed and duplex setting if you're using Ethernet encapsulation. This field displays N/A when the line is disconnected. For the 2.4GHz/5GHz WLAN, it displays the maximum transmission rate when the 2.4GHz/5GHz WLAN is enabled and N/A when the WLAN is disabled.

6.2.1 Navigation Panel

Use the sub-menus on the navigation panel to configure NBG6616 features.

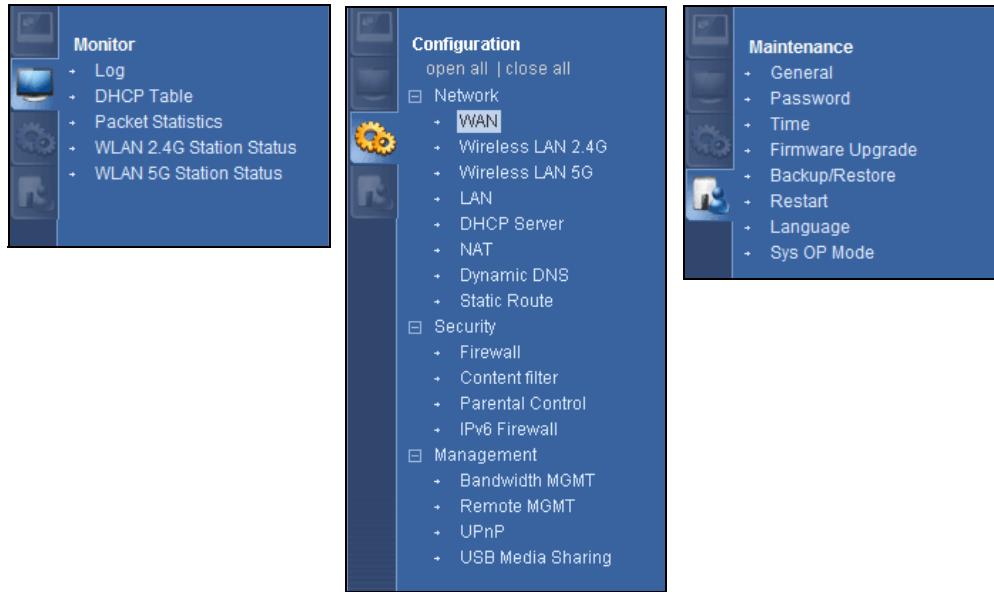
Figure 31 Navigation Panel: Router Mode

The following table describes the sub-menus.

Table 20 Navigation Panel: Router Mode

LINK	TAB	FUNCTION
Status		This screen shows the NBG6616's general device, system and interface status information. Use this screen to access the wizard, and summary statistics tables.
Monitor		
Log		Use this screen to view the list of activities recorded by your NBG6616.
DHCP Table		Use this screen to view current DHCP client information.
Packet Statistics		Use this screen to view port status and packet specific statistics.
WLAN 2.4G Station Status		Use this screen to view the wireless stations that are currently associated to the NBG6616's 2.4GHz wireless LAN.
WLAN 5G Station Status		Use this screen to view the wireless stations that are currently associated to the NBG6616's 5GHz wireless LAN.
Configuration		
Network		
WAN	Internet Connection	This screen allows you to configure ISP parameters, WAN IP address assignment, DNS servers and the WAN MAC address.
	Advanced	Use this screen to configure other advanced properties.

Table 20 Navigation Panel: Router Mode (continued)

LINK	TAB	FUNCTION
Wireless LAN 2.4G/5G	General	Use this screen to enable the wireless LAN and configure wireless LAN and wireless security settings.
	More AP	Use this screen to configure multiple BSSs on the NBG6616.
	MAC Filter	Use the MAC filter screen to configure the NBG6616 to block access to devices or block the devices from accessing the NBG6616.
	Advanced	This screen allows you to configure advanced wireless settings.
	QoS	Use this screen to configure Wi-Fi Multimedia Quality of Service (WMM QoS). WMM QoS allows you to prioritize wireless traffic according to the delivery requirements of individual services.
	WPS	Use this screen to configure WPS.
	WPS Station	Use this screen to add a wireless station using WPS.
	Scheduling	Use this screen to schedule the times the Wireless LAN is enabled.
LAN	IP	Use this screen to configure LAN IP address and subnet mask.
	IP Alias	Use this screen to have the NBG6616 apply IP alias to create LAN subnets.
	IPv6 LAN	Use this screen to configure the IPv6 address for the NBG6616 on the LAN.
DHCP Server	General	Use this screen to enable the NBG6616's DHCP server.
	Advanced	Use this screen to assign IP addresses to specific individual computers based on their MAC addresses and to have DNS servers assigned by the DHCP server.
	Client List	Use this screen to view information related to your DHCP status.
NAT	General	Use this screen to enable NAT.
	Port Forwarding	Use this screen to configure servers behind the NBG6616 and forward incoming service requests to the server(s) on your local network.
	Port Trigger	Use this screen to change your NBG6616's port triggering settings.
Dynamic DNS	Dynamic DNS	Use this screen to set up dynamic DNS.
Static Route	Static Route	Use this screen to configure IP static routes.
Security		
Firewall	General	Use this screen to activate/deactivate the firewall.
	Services	This screen shows a summary of the firewall rules, and allows you to edit/add a firewall rule.
Content Filter	Content Filter	Use this screen to restrict web features and designate a trusted computer.
Parental Control		Use this screen to block certain web features and sites containing certain keywords in the URL.
IPv6 firewall	Services	Use this screen to configure IPv6 firewall rules.
Management		
Bandwidth Management	General	Use this screen to enable bandwidth management.
	Advanced	Use this screen to set the upstream bandwidth and edit a bandwidth management rule.
Remote Management	WWW	Use this screen to configure through which interface(s) and from which IP address(es) users can use HTTP to manage the NBG6616.
	Telnet	Use this screen to configure through which interface(s) and from which IP address(es) users can use Telnet to manage the NBG6616.
	Wake On LAN	Use this screen to enable Wake on LAN to remotely turn on a device on the local network.

Table 20 Navigation Panel: Router Mode (continued)

LINK	TAB	FUNCTION
UPnP	UPnP	Use this screen to enable UPnP on the NBG6616.
USB Media Sharing	DLNA	Use this screen to have the NBG6616 function as a DLNA-compliant media server, that lets DLNA-compliant media clients play video, audio, and photo content files stored on the connected USB storage device.
	SAMBA	Use this screen to enable file sharing through the NBG6616.
	FTP	Use this screen to have the NBG6616 act as a FTP server.
Maintenance		
General	General	Use this screen to view and change administrative settings such as system and domain names.
Password	Password Setup	Use this screen to change the password of your NBG6616.
Time	Time Setting	Use this screen to change your NBG6616's time and date.
Firmware Upgrade	Firmware Upgrade	Use this screen to upload firmware to your NBG6616.
Backup/Restore	Backup/Restore	Use this screen to backup and restore the configuration or reset the factory defaults to your NBG6616.
Restart	System Restart	This screen allows you to reboot the NBG6616 without turning the power off.
Language	Language	This screen allows you to select the language you prefer.
Sys OP Mode	Sys OP Mode	This screen allows you to select whether your device acts as a router, or an access point.

Access Point Mode

7.1 Overview

Use your NBG6616 as an access point (AP) if you already have a router or gateway on your network. In this mode your NBG6616 bridges a wired network (LAN) and wireless LAN (WLAN) in the same subnet. See the figure below for an example.

Figure 32 Wireless Internet Access in Access Point Mode

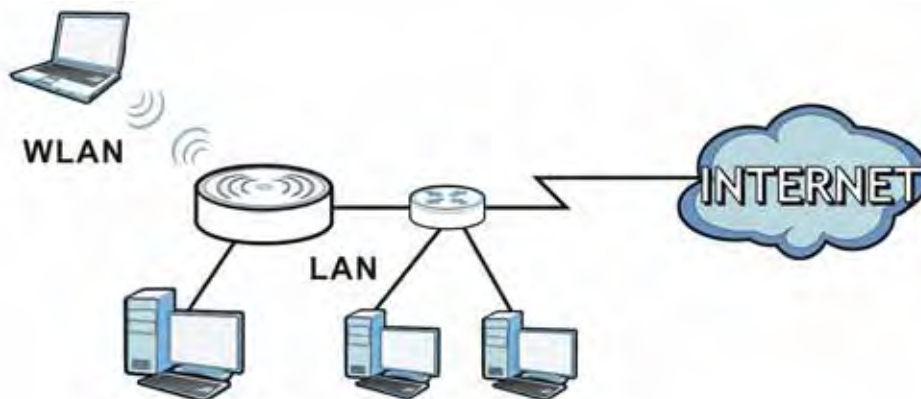

Many screens that are available in **Router Mode** are not available in **Access Point Mode**, such as bandwidth management and firewall.

7.2 What You Can Do

- Use the **Status** screen to view read-only information about your NBG6616 ([Section 7.4 on page 51](#)).
- Use the **LAN** screen to set the IP address for your NBG6616 acting as an access point ([Section 7.5 on page 53](#)).

7.3 What You Need to Know

See [Chapter 8 on page 56](#) for a tutorial on setting up a network with the NBG6616 as an access point.

7.3.1 Setting your NBG6616 to AP Mode

- 1 Log into the Web Configurator if you haven't already. See the Quick start Guide for instructions on how to do this.
- 2 To use your NBG6616 as an access point, go to **Maintenance > Sys OP Mode** and select **Access Point Mode**.

Figure 33 Changing to Access Point mode

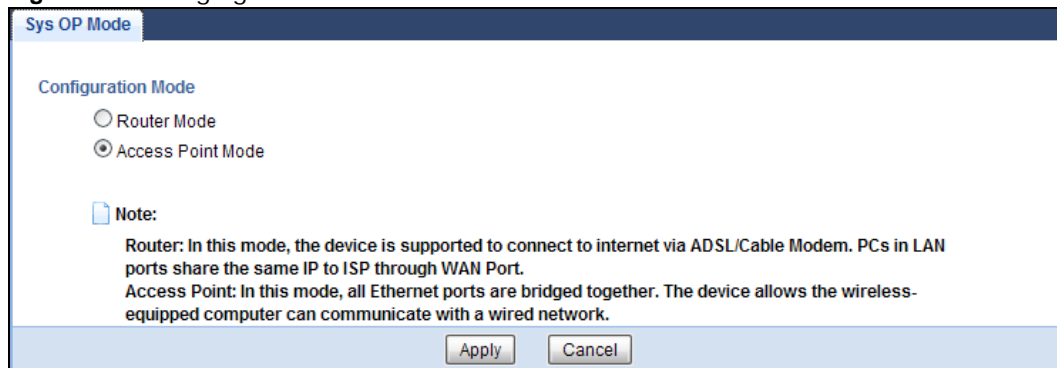

Note: You have to log in to the Web Configurator again when you change modes. As soon as you do, your NBG6616 is already in Access Point mode.

- 3 When you select **Access Point Mode**, the following pop-up message window appears.

Figure 34 Pop up for Access Point mode

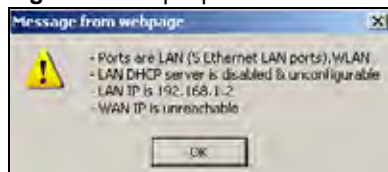

Click **OK**. Then click **Apply**. The Web Configurator refreshes once the change to Access Point mode is successful.

7.3.2 Accessing the Web Configurator in Access Point Mode

Log in to the Web Configurator in Access Point mode, do the following:

- 1 Connect your computer to the LAN port of the NBG6616.
- 2 The default IP address of the NBG6616 is "192.168.1.2". In this case, your computer must have an IP address in the range between "192.168.1.3" and "192.168.1.254".
- 3 Click **Start > Run** on your computer in Windows. Type "cmd" in the dialog box. Enter "ipconfig" to show your computer's IP address. If your computer's IP address is not in the correct range then see [Appendix B on page 200](#) for information on changing your computer's IP address.
- 4 After you've set your computer's IP address, open a web browser such as Internet Explorer and type "192.168.1.2" as the web address in your web browser.

Note: After clicking **Login**, the **Easy Mode** appears. Refer to [Section on page 31](#) for the **Easy Mode** screens. Change to **Expert Mode** to see the screens described in the sections following this.

7.3.3 Configuring your WLAN and Maintenance Settings

The configuration of wireless and maintenance settings in **Access Point Mode** is the same as for **Router Mode**.

- See [Chapter 11 on page 84](#) for information on the configuring your wireless network.
- See [Chapter 25 on page 174](#) for information on configuring your Maintenance settings.

7.4 AP Mode Status Screen

Click  to open the **Status** screen.

Figure 35 Status Screen: Access Point Mode



The screenshot shows the ZyXEL NBG6616 Status screen. The interface includes a 'Refresh Interval' dropdown set to 'None' and a 'Refresh Now' button. The main content is divided into several sections:

- Device Information:** A table listing host name (NBG6616), model number (NBG6616), firmware version (V1.00(AAR0.0)b1), and system operation mode (AP Mode).
- LAN Information:** A table listing MAC address (00:AA:BB:CC:DD:02), IP address (192.168.1.2), IP subnet mask (255.255.255.0), DHCP status (None), and IPv6 address.
- WLAN 2.4G Information:** A table listing WLAN operation mode (Access Point Mode), MAC address (00:AA:BB:CC:DD:00), SSID (ZyXELCCDD00), channel (11), and security (WPA2-PSK).
- WLAN 5G Information:** A table listing MAC address (00:AA:BB:CC:DD:01), SSID (ZyXELCCDD00), channel (149), and security (WPA2-PSK).
- System Status:** A table listing system up time (0 day 0 hr 7 min 3 sec), current date/time (2014-03-24/04:02:49), and system resource usage (CPU Usage: 11%, Memory Usage: 49%).
- Interface Status:** A table listing the status and rate of various interfaces: LAN1-5 (all Down), WLAN 2.4G (UP, 450M), and WLAN 5G (UP, 1.30).
- Summary:** A section with links for Packet Statistics, WLAN 2.4G Station Status, and WLAN 5G Station Status.

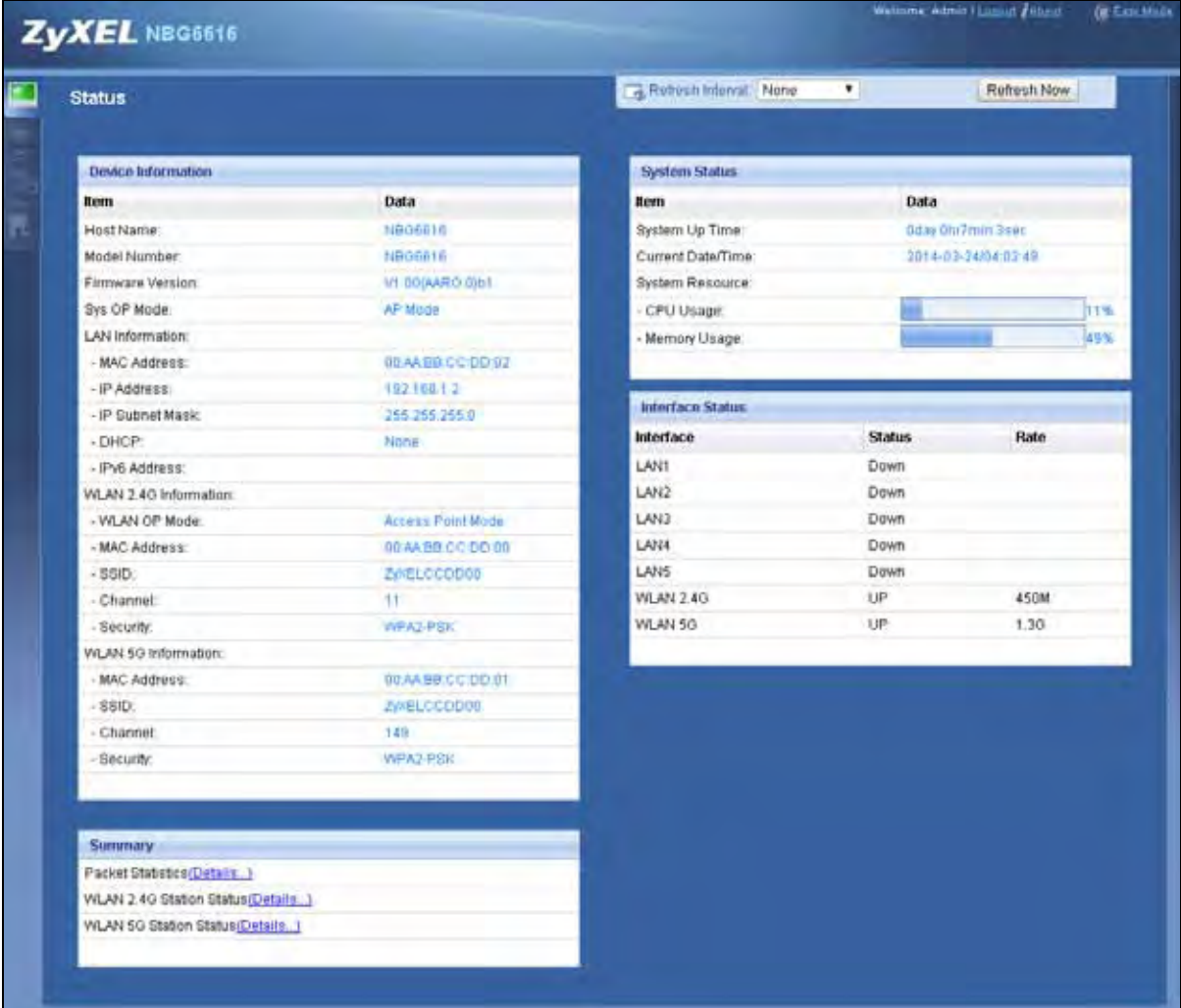
The following table describes the labels shown in the **Status** screen.

Table 21 Status Screen: Access Point Mode

LABEL	DESCRIPTION
Device Information	
Host Name	This is the System Name you enter in the Maintenance > General screen. It is for identification purposes.
Model Number	This is the model name of your device.
Firmware Version	This is the firmware version and the date created.
Sys OP Mode	This is the device mode (Section 4.1.2 on page 30) to which the NBG6616 is set - AP Mode .
LAN Information	
MAC Address	This shows the LAN Ethernet adapter MAC Address of your device.
IP Address	This shows the LAN port's IP address.
IP Subnet Mask	This shows the LAN port's subnet mask.
DHCP	This shows the LAN port's DHCP role - Client or None .
IPv6 Address	This shows the IPv6 address of the NBG6616 on the LAN.
WLAN 2.4G Information	
WLAN OP Mode	This is the device mode (Section 4.1.2 on page 30) to which the NBG6616's wireless LAN is set - Access Point Mode .
MAC Address	This shows the 2.4GHz wireless adapter MAC Address of your device.
SSID	This shows a descriptive name used to identify the NBG6616 in the 2.4GHz wireless LAN.
Channel	This shows the channel number which you select manually.
Security	This shows the level of wireless security the NBG6616 is using.
WLAN 5G Information	
MAC Address	This shows the 5GHz wireless adapter MAC Address of your device.
SSID	This shows a descriptive name used to identify the NBG6616 in the 5GHz wireless LAN.
Channel	This shows the channel number which you select manually.
Security	This shows the level of wireless security the NBG6616 is using.
Summary	
Packet Statistics	Click Details... to go to the Monitor > Packet Statistics screen (Section 9.5 on page 71). Use this screen to view port status and packet specific statistics.
WLAN 2.4G Station Status	Click Details... to go to the Monitor > WLAN 2.4G Station Status screen (Section 9.6 on page 72). Use this screen to view the wireless stations that are currently associated to the NBG6616's 2.4GHz wireless LAN.
WLAN 5G Station Status	Click Details... to go to the Monitor > WLAN 5G Station Status screen (Section 9.6 on page 72). Use this screen to view the wireless stations that are currently associated to the NBG6616's 5GHz wireless LAN.
System Status	
Item	This column shows the type of data the NBG6616 is recording.
Data	This column shows the actual data recorded by the NBG6616.
System Up Time	This is the total time the NBG6616 has been on.
Current Date/Time	This field displays your NBG6616's present date and time.
System Resource	
- CPU Usage	This displays what percentage of the NBG6616's processing ability is currently used. When this percentage is close to 100%, the NBG6616 is running at full load, and the throughput is not going to improve anymore. If you want some applications to have more throughput, you should turn off other applications (for example, using bandwidth management.)

Table 21 Status Screen: Access Point Mode (continued)

LABEL	DESCRIPTION
- Memory Usage	This shows what percentage of the heap memory the NBG6616 is using.
Interface Status	
Interface	This displays the NBG6616 port types. The port types are: LAN and WLAN .
Status	For the LAN ports, this field displays Down (line is down) or Up (line is up or connected). For the 2.4GHz/5GHz WLAN, it displays Up when the 2.4GHz/5GHz WLAN is enabled or Down when the 2.4G/5G WLAN is disabled.
Rate	For the LAN ports, this displays the port speed and duplex setting or N/A when the line is disconnected. For the 2.4GHz/5GHz WLAN, it displays the maximum transmission rate when the 2.4GHz/5GHz WLAN is enabled and N/A when the WLAN is disabled.

7.4.1 Navigation Panel

Use the menu in the navigation panel to configure NBG6616 features in **Access Point Mode**.

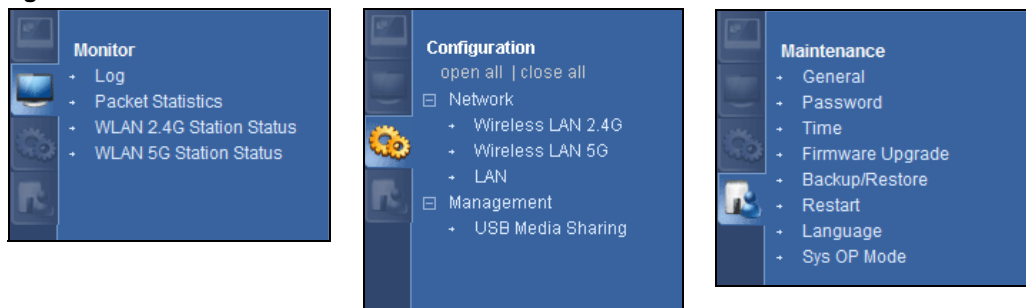
Figure 36 Menu: Access Point Mode

Refer to [Table 20 on page 46](#) for descriptions of the labels shown in the navigation panel.

7.5 LAN Screen

Use this section to configure your LAN settings while in **Access Point Mode**.

Click **Network > LAN** to see the screen below.

Note: If you change the IP address of the NBG6616 in the screen below, you will need to log into the NBG6616 again using the new IP address.

Figure 37 Network > LAN > IP

The table below describes the labels in the screen.

Table 22 Network > LAN > IP

LABEL	DESCRIPTION
Obtain an IP Address Automatically	When you enable this, the NBG6616 gets its IP address from the network's DHCP server (for example, your ISP). Users connected to the NBG6616 can now access the network (i.e., the Internet if the IP address is given by the ISP). The Web Configurator may no longer be accessible unless you know the IP address assigned by the DHCP server to the NBG6616. You need to reset the NBG6616 to be able to access the Web Configurator again (see Section 25.7 on page 179 for details on how to reset the NBG6616). Also when you select this, you cannot enter an IP address for your NBG6616 in the field below.
Static IP Address	Click this if you want to specify the IP address of your NBG6616. Or if your ISP or network administrator gave you a static IP address to access the network or the Internet.
IP Address	Type the IP address in dotted decimal notation. The default setting is 192.168.1.2. If you change the IP address you will have to log in again with the new IP address.
Subnet Mask	The subnet mask specifies the network number portion of an IP address. Your NBG6616 will automatically calculate the subnet mask based on the IP address that you assign. Unless you are implementing subnetting, use the subnet mask computed by the NBG6616.
Gateway IP Address	Enter a Gateway IP Address (if your ISP or network administrator gave you one) in this field.
DNS Assignment	

Table 22 Network > LAN > IP (continued)

LABEL	DESCRIPTION
First DNS Server	Select Obtained From ISP if your ISP dynamically assigns DNS server information (and the NBG6616's WAN IP address). The field to the right displays the (read-only) DNS server IP address that the ISP assigns.
Second DNS Server	
Third DNS Server	
	Select User-Defined if you have the IP address of a DNS server. Enter the DNS server's IP address in the field to the right. If you chose User-Defined , but leave the IP address set to 0.0.0.0, User-Defined changes to None after you click Apply . If you set a second choice to User-Defined , and enter the same IP address, the second User-Defined changes to None after you click Apply .
	Select None if you do not want to configure DNS servers. If you do not configure a DNS server, you must know the IP address of a computer in order to access it.
Apply	Click Apply to save your changes to the NBG6616.
Cancel	Click Cancel to reload the previous configuration for this screen.

8.1 Overview

This chapter provides tutorials for setting up your NBG6616.

- [Set Up a Wireless Network Using WPS](#)
- [Connect to NBG6616 Wireless Network without WPS](#)
- [Using Multiple SSIDs on the NBG6616](#)

8.2 Set Up a Wireless Network Using WPS

This section gives you an example of how to set up wireless network using WPS. This example uses the NBG6616 as the AP and NWD210N as the wireless client which connects to a notebook.

Note: The wireless client must be a WPS-aware device (for example, a WPS USB adapter or PCI card).

There are two WPS methods for creating a secure connection via the web configurator or utility. This tutorial shows you how to do both.

- **Push Button Configuration (PBC)** - create a secure wireless network simply by pressing a button. See [Section 8.2.1 on page 56](#). This is the easier method.
- **PIN Configuration** - create a secure wireless network simply by entering a wireless client's PIN (Personal Identification Number) in the NBG6616's interface. See [Section 8.2.2 on page 57](#). This is the more secure method, since one device can authenticate the other.

8.2.1 Push Button Configuration (PBC)

- 1 Make sure that your NBG6616 is turned on. Make sure the **WIFI** button (at the back panel of the NBG6616) is pushed in, and that the device is placed within range of your notebook.
- 2 Make sure that you have installed the wireless client (this example uses the NWD210N) driver and utility in your notebook.
- 3 In the wireless client utility, find the WPS settings. Enable WPS and press the WPS button (**Start** or **WPS** button)
- 4 Log into NBG6616's Web Configurator and press the **Push Button** in the **Configuration > Network > Wireless LAN 2.4G > WPS Station** screen.

Note: Your NBG6616 has a WPS button located on its panel, as well as a WPS button in its configuration utility. Both buttons have exactly the same function; you can use one or the other.

Note: It doesn't matter which button is pressed first. You must press the second button within two minutes of pressing the first one.

The NBG6616 sends the proper configuration settings to the wireless client. This may take up to two minutes. Then the wireless client is able to communicate with the NBG6616 securely.

The following figure shows you an example to set up wireless network and security by pressing a button on both NBG6616 and wireless client (the NWD210N in this example).

Figure 38 Example WPS Process: PBC Method

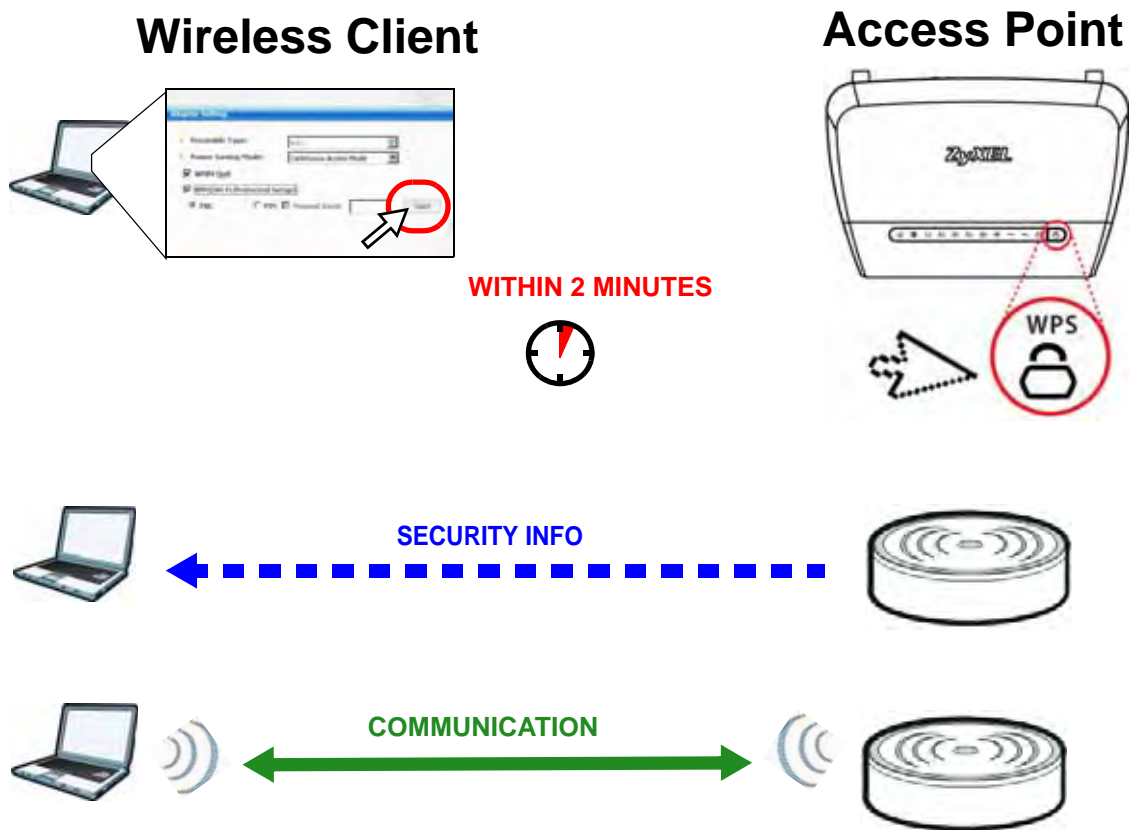

8.2.2 PIN Configuration

When you use the PIN configuration method, you need to use both NBG6616's configuration interface and the client's utilities.

- 1 Launch your wireless client's configuration utility. Go to the WPS settings and select the PIN method to get a PIN number.
- 2 Enter the PIN number to the **PIN** field in the **Configuration > Network > Wireless LAN 2.4G > WPS Station** screen on the NBG6616.

- 3 Click **Start** buttons (or button next to the PIN field) on both the wireless client utility screen and the NBG6616's **WPS Station** screen within two minutes.

The NBG6616 authenticates the wireless client and sends the proper configuration settings to the wireless client. This may take up to two minutes. Then the wireless client is able to communicate with the NBG6616 securely.

The following figure shows you the example to set up wireless network and security on NBG6616 and wireless client (ex. NWD210N in this example) by using PIN method.

Figure 39 Example WPS Process: PIN Method

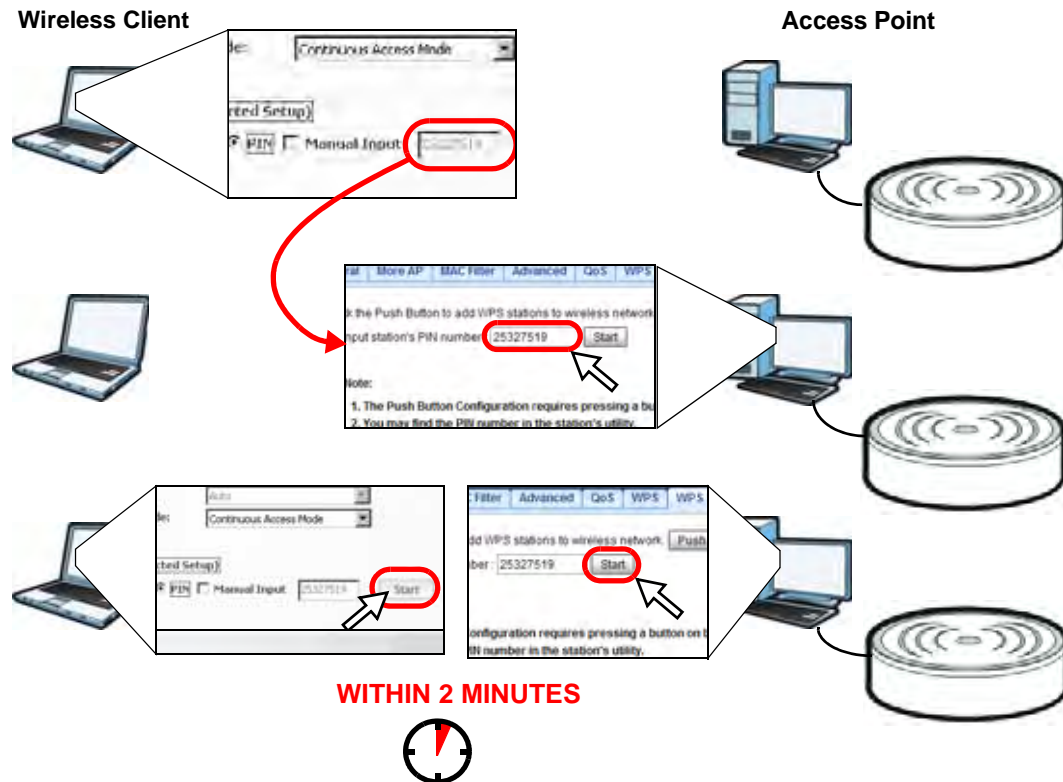

8.3 Connect to NBG6616 Wireless Network without WPS

This example shows you how to configure wireless security settings with the following parameters on your NBG6616 and connect your computer to the NBG6616 wireless network.

SSID	SSID_Example3
Channel	6
Security	WPA2-PSK (Pre-Shared Key: ThisismyWPA-PSKpre-sharedkey)

Follow the steps below to configure the wireless settings on your NBG6616.

The instructions require that your hardware is connected (see the Quick Start Guide) and you are logged into the Web Configurator through your LAN connection (see [Section 2.2 on page 17](#)).

- 1 Make sure the **WIFI** switch (at the back panel of the NBG6616) is set to **ON**.
- 2 Open the **Configuration > Network > Wireless LAN 2.4G > General** screen in the AP's Web Configurator.
- 3 Confirm that the wireless LAN is enabled on the NBG6616.
- 4 Enter **SSID_Example3** as the SSID and select **Channel-06** as the channel. Set security mode to **WPA2-PSK** and enter **ThisismyWPA-PSKpre-sharedkey** in the **Pre-Shared Key** field. Click **Apply**.

The screenshot displays the 'Wireless LAN 2.4G' configuration page, specifically the 'General' tab. The 'Wireless Setup' section includes the following fields:

- Wireless LAN:** Enable Disable
- Name (SSID):** SSID_Example3
- Hide SSID
- Channel Selection:** Channel-6 2437MHz (dropdown), Auto Channel Selection
- Operating Channel:** Channel-
- Channel Width:** Auto 20/40 MHz (dropdown)
- 802.11 Mode:** 802.11bgn (dropdown)

The 'Security' section includes the following fields:

- Security Mode:** WPA2-PSK (dropdown)
- WPA-PSK Compatible
- Pre-Shared Key:** ThisismyWPA-PSKpre-sharedkey
- Group Key Update Timer:** 3600 seconds

A note at the bottom states: 'Note: No Security and WPA2-PSK can be configured when WPS enabled.' The 'Apply' and 'Cancel' buttons are visible at the bottom of the form.

- 5 Open the **Status** screen. Verify your wireless and wireless security settings under **Device Information** and check if the WLAN connection is up under **Interface Status**.

The screenshot displays the ZyXEL NBG6616 web interface. The main content area is titled "Status" and includes a "Refresh Interval" dropdown set to "None" and a "Refresh Now" button. The interface is organized into several panels:

- Device Information:** A table listing various system parameters. The "WLAN 2.4G Information" section is highlighted with a red circle.

Item	Data
Host Name:	NBG6616
Model Number:	NBG6616
Firmware Version:	V1.00(AAP0.0)
Sys OP Mode:	ROUTER Mode
WAN Information	
- MAC Address:	00AA:BB:CC:DD:03
- IP Address:	
- IP Subnet Mask:	
- Default Gateway:	
- IPv6 Address:	
LAN Information:	
- MAC Address:	00AA:BB:CC:DD:02
- IP Address:	192.168.1.1
- IP Subnet Mask:	255.255.255.0
- DHCP:	Server
- IPv6 Address:	
WLAN 2.4G Information:	
- WLAN OP Mode:	Access Point Mode
- MAC Address:	00AA:BB:CC:DD:00
- SSID:	SSID_Example3
- Channel:	5
- Security:	WPA-PSK / WPA2-PSK
WLAN 5G Information:	
- MAC Address:	00AA:BB:CC:DD:01
- SSID:	ZyXELCCDD00
- Channel:	149
- Security:	WPA2-PSK
Firewall:	Enable
- System Status:** Shows system up time (0day 0hr 19min 45sec), current date/time (2014-03-24/03:15:41), and system resources (CPU Usage: 5%, Memory Usage: 49%).
- Interface Status:** A table showing the status of various interfaces. The "WLAN 2.4G" interface is circled in red, indicating it is "UP" with a "Rate" of "450M".

Interface	Status	Rate
WAN	Down	
LAN1	Down	
LAN2	Down	
LAN3	Down	
LAN4	Down	
WLAN 2.4G	UP	450M
WLAN 5G	UP	1.3G
- Summary:** Includes links for "Packet Statistics (Details...)", "WLAN 2.4G Station Status (Details...)", and "WLAN 5G Station Status (Details...)"

8.3.1 Configure Your Notebook

Note: In this example, we use the ZyXEL NWD6505 wireless adapter as the wireless client and use the Windows built-in utility (Windows Zero Configuration (WZC)) to connect to the wireless network.

- 1 The NBG6616 supports IEEE 802.11a, IEEE 802.11b, IEEE 802.11g, IEEE 802.11n and IEEE 802.11ac wireless clients. Make sure that your notebook or computer's wireless adapter supports one of these standards.
- 2 Wireless adapters come with software sometimes called a "utility" that you install on your computer. See your wireless adapter's User's Guide for information on how to do that.

- After you've installed the driver and attached the NWD6505 to your computer's USB port, right-click the **Wireless Network Connection** icon in your computer's system tray, select and click **View Available Wireless Networks**.



- The **Wireless Network Connection** screen displays. Click **Refresh network list** to view the available wireless APs within range.
- Select **SSID_Example3** and click **Connect**.

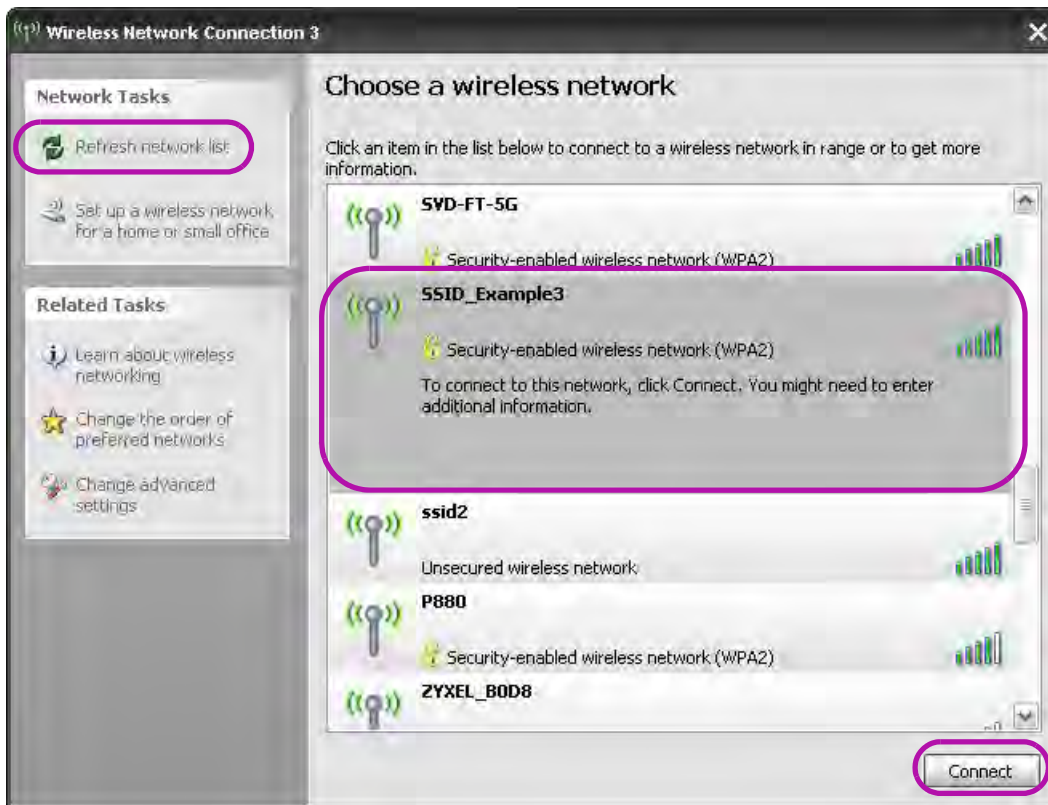

- Type the security key in the following screen. Click **Connect**.

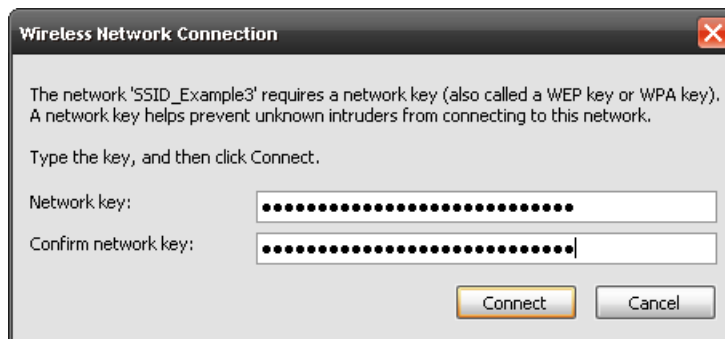

- 7 Check the status of your wireless connection in the screen below.

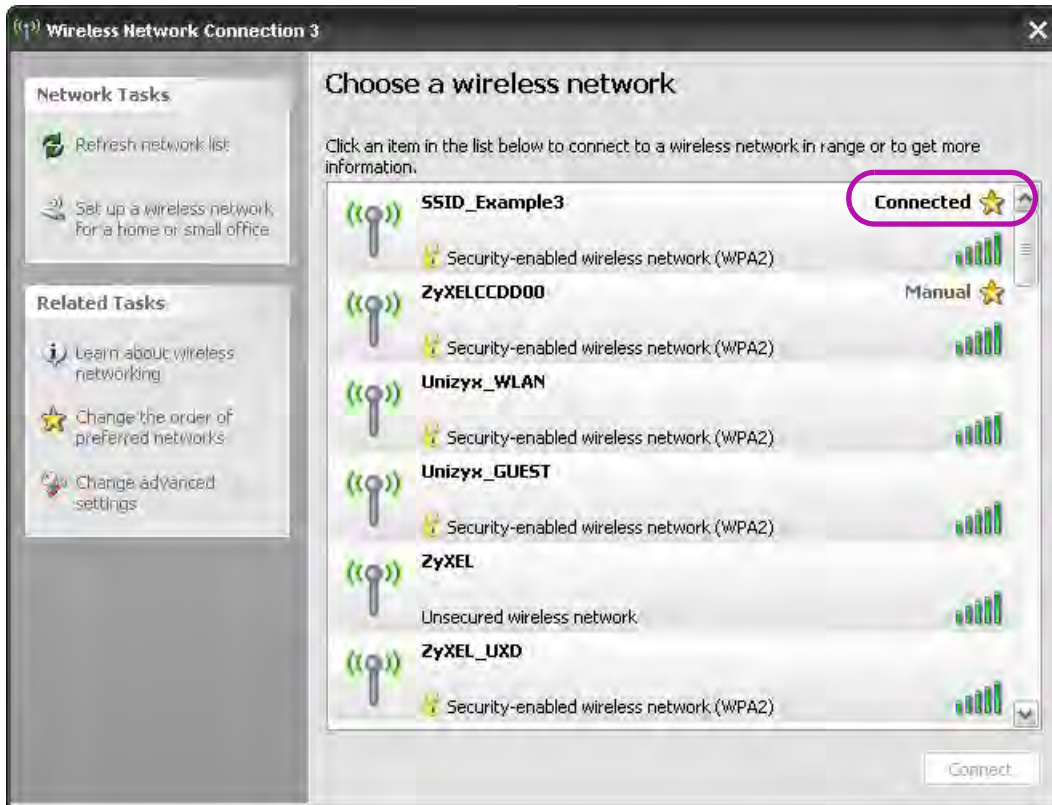

- 8 If the wireless client keeps trying to connect to or acquiring an IP address from the NBG6616, make sure you entered the correct security key.

If the connection has limited or no connectivity, make sure the DHCP server is enabled on the NBG6616.

If your connection is successful, open your Internet browser and enter <http://www.zyxel.com> or the URL of any other web site in the address bar. If you are able to access the web site, your wireless connection is successfully configured.

8.4 Using Multiple SSIDs on the NBG6616

You can configure more than one SSID on a NBG6616. See [Section 11.4 on page 97](#).

This allows you to configure multiple independent wireless networks on the NBG6616 as if there were multiple APs (virtual APs). Each virtual AP has its own SSID, wireless security type and MAC filtering settings. That is, each SSID on the NBG6616 represents a different access point/wireless network to wireless clients in the network.

Clients can associate only with the SSIDs for which they have the correct security settings. Clients using different SSIDs can access the Internet and the wired network behind the NBG6616 (such as a printer).

For example, you may set up three wireless networks (**A**, **B** and **C**) in your office. **A** is for workers, **B** is for guests and **C** is specific to a VoIP device in the meeting room.

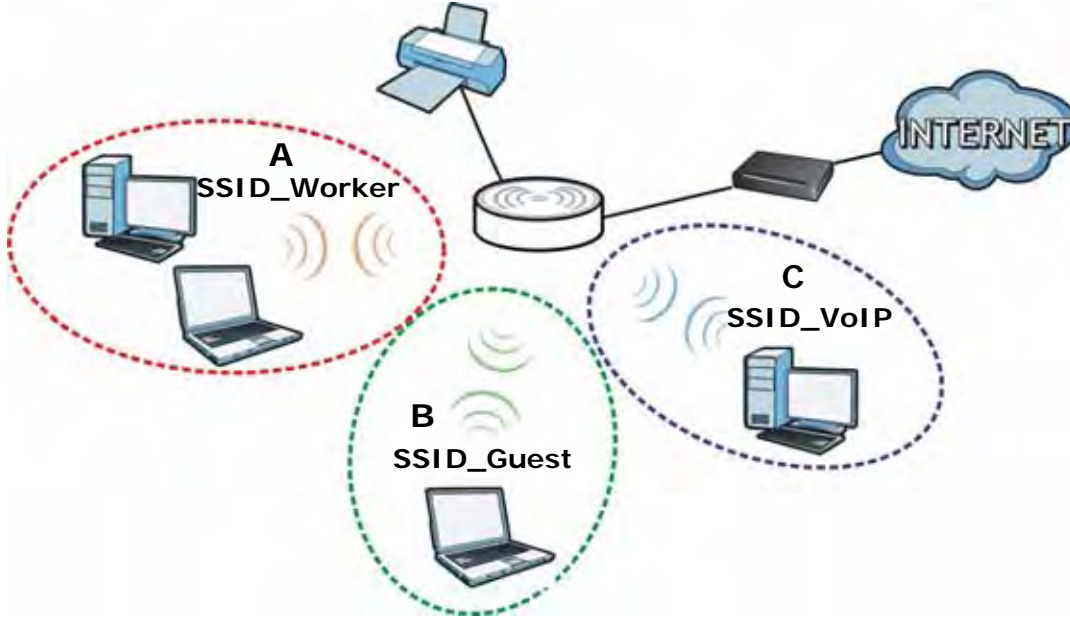

8.4.1 Configuring Security Settings of Multiple SSIDs

The NBG6616 is in router mode by default.

This example shows you how to configure the SSIDs with the following parameters on your NBG6616 (in router mode).

SSID	SECURITY TYPE	KEY	MAC FILTERING
SSID_Worker	WPA2-PSK WPA Compatible	DoNotStealMyWirelessNetwork	Disable
SSID_VoIP	WPA-PSK	VoIPOnly12345678	Allow 00:A0:C5:01:23:45
SSID_Guest	WPA-PSK	keyexample123	Disable

- 1 Connect your computer to the LAN port of the NBG6616 using an Ethernet cable.
- 2 The default IP address of the NBG6616 in router mode is "192.168.1.1". In this case, your computer must have an IP address in the range between "192.168.1.2" and "192.168.1.254".
- 3 Click **Start > Run** on your computer in Windows. Type "cmd" in the dialog box. Enter "ipconfig" to show your computer's IP address. If your computer's IP address is not in the correct range then see [Appendix B on page 200](#) for information on changing your computer's IP address.
- 4 After you've set your computer's IP address, open a web browser such as Internet Explorer and type "http://192.168.1.1" as the web address in your web browser.
- 5 Enter "1234" (default) as the password and click **Login**.

- 6 Type a new password and retype it to confirm, then click **Apply**. Otherwise, click **Ignore**.
- 7 The **Easy Mode** appears. Click **Expert Mode** in the navigation panel.
- 8 Go to **Configuration > Network > Wireless LAN 2.4G > More AP**. Click the **Edit** icon of the first entry to configure wireless and security settings for **SSID_Worker**.

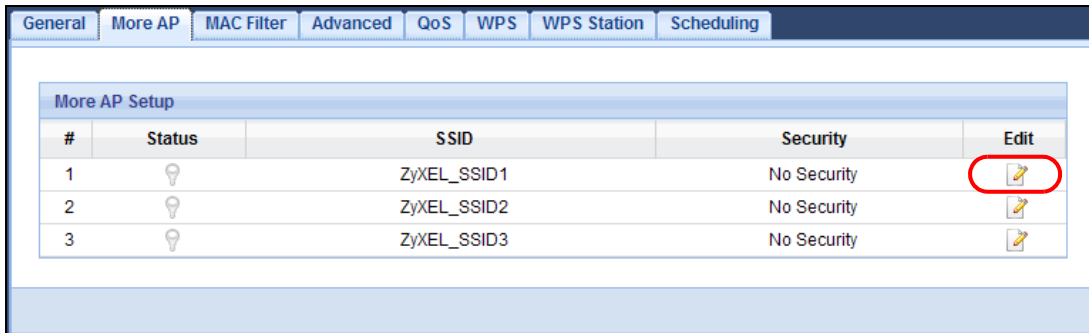

- 9 Configure the screen as follows. In this example, you enable **Intra-BSS Traffic** for **SSID_Worker** to allow wireless clients in the same wireless network to communicate with each other. Click **Apply**.

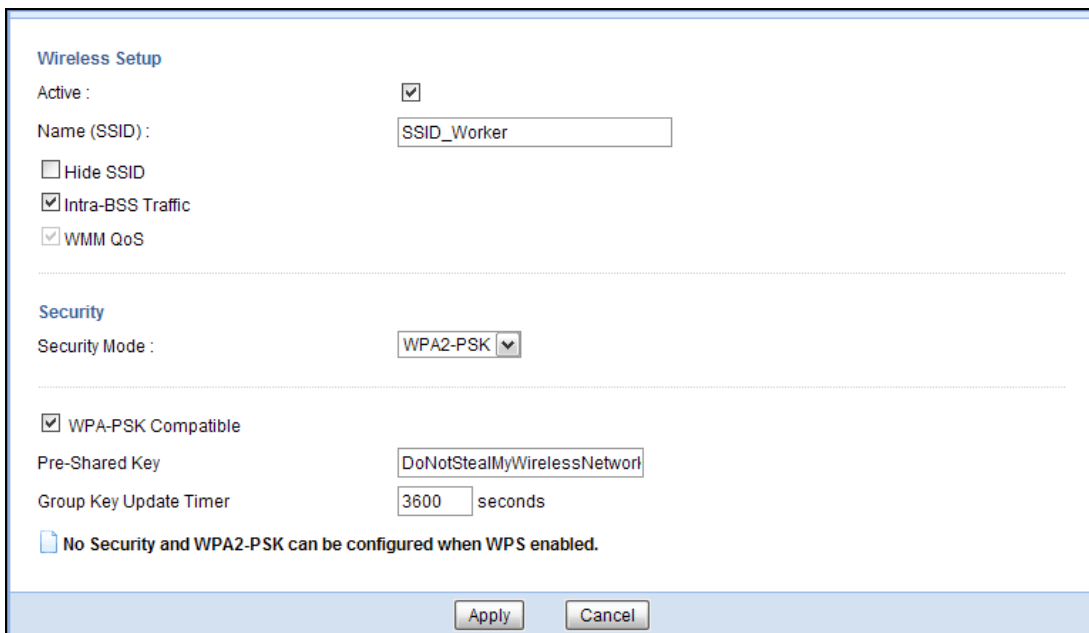

- 10 Click the **Edit** icon of the second entry to configure wireless and security settings for **SSID_VoIP**.

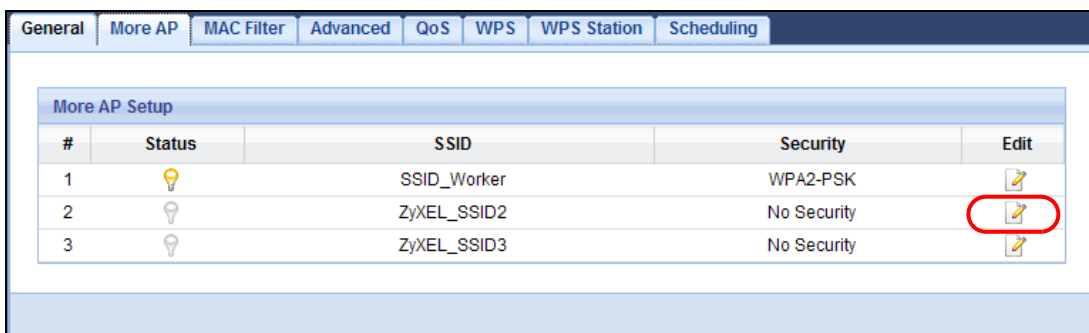

- 11 Configure the screen as follows. You do not enable **Intra-BSS Traffic** for **SSID_VoIP**. Click **Apply**.

Wireless Setup

Active :

Name (SSID) :

Hide SSID

Intra-BSS Traffic

WMM QoS

Security

Security Mode :

Pre-Shared Key :

Group Key Update Timer : seconds

No Security and WPA2-PSK can be configured when WPS enabled.

- 12 Click the **Edit** icon of the third entry to configure wireless and security settings for **SSID_Guest**.

#	Status	SSID	Security	Edit
1		SSID_Worker	WPA2-PSK	
2		SSID_VoIP	WPA-PSK	
3		ZyXEL_SSID3	No Security	

- 13 Configure the screen as follows. In this example, you enable **Intra-BSS Traffic** for **SSID_Guest** to allow wireless clients in the same wireless network to communicate with each other. Select **Enable Guest WLAN** to allow clients to access the Internet only. Click **Apply**.

Wireless Setup

Active :

Name (SSID) :

Hide SSID

Intra-BSS Traffic

WMM QoS

Enable Guest WLAN

IP Address :

IP Subnet Mask :

Enable Bandwidth Management for Guest WLAN

Maximum Bandwidth (kbps)

Security

Security Mode :

Pre-Shared Key

Group Key Update Timer seconds

No Security and WPA2-PSK can be configured when WPS enabled.

- 14 Click the **MAC Filter** tab to configure MAC filtering for the **SSID_VoIP** wireless network. Select **SSID_VoIP** from the **SSID Select** drop-down list, enable MAC address filtering and set the **Filter Action** to **Allow**. Enter the VoIP device's MAC address in the **Mac Address** field and click **Apply** to allow only the VoIP device to associate with the NBG6616 using this SSID.

General More AP **MAC Filter** Advanced QoS WPS WPS Station Scheduling

SSID Select: SSID_VoIP

MAC Address Filter: Enable Disable

Filter Action: Allow Deny

MAC Filter Summary

Set	MAC Address	Set	MAC Address
1	00:A0:C5:01:23:45	17	00:00:00:00:00:00
2	00:00:00:00:00:00	18	00:00:00:00:00:00
3	00:00:00:00:00:00	19	00:00:00:00:00:00
6	00:00:00:00:00:00	22	00:00:00:00:00:00
7	00:00:00:00:00:00	23	00:00:00:00:00:00
8	00:00:00:00:00:00	24	00:00:00:00:00:00
9	00:00:00:00:00:00	25	00:00:00:00:00:00
10	00:00:00:00:00:00	26	00:00:00:00:00:00
11	00:00:00:00:00:00	27	00:00:00:00:00:00
12	00:00:00:00:00:00	28	00:00:00:00:00:00
13	00:00:00:00:00:00	29	00:00:00:00:00:00
14	00:00:00:00:00:00	30	00:00:00:00:00:00
15	00:00:00:00:00:00	31	00:00:00:00:00:00
16	00:00:00:00:00:00	32	00:00:00:00:00:00

Apply Cancel

PART II

Technical Reference

Monitor

9.1 Overview

This chapter discusses read-only information related to the device state of the NBG6616.

To access the Monitor screens, go to **Expert Mode** after login, then click .

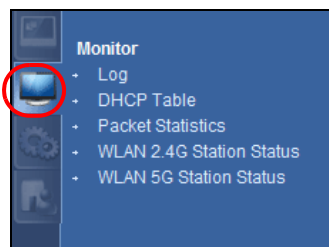

You can also click the links in the **Summary** table of the **Status** screen to view the packets sent/received as well as the status of clients connected to the NBG6616.

9.2 What You Can Do

- Use the **Log** screen to see the logs for the activity on the NBG6616 ([Section 9.3 on page 69](#)).
- Use the **DHCP Table** screen to view information related to your DHCP status ([Section 9.4 on page 70](#)).
- use the **Packet Statistics** screen to view port status, packet specific statistics, the "system up time" and so on ([Section 9.5 on page 71](#)).
- Use the **WLAN 2.4G/5G Station Status** screen to view the wireless stations that are currently associated to the NBG6616 ([Section 9.6 on page 72](#)).

9.3 The Log Screen

The Web Configurator allows you to look at all of the NBG6616's logs in one location.

9.3.1 View Log

Use the **View Log** screen to see the logged messages for the NBG6616. The log wraps around and deletes the old entries after it fills. Select what logs you want to see from the **Display** drop list. The log choices depend on your settings in the **Log Setting** screen. Click **Refresh** to renew the log screen. Click **Clear Log** to delete all the logs.

Figure 40 View Log

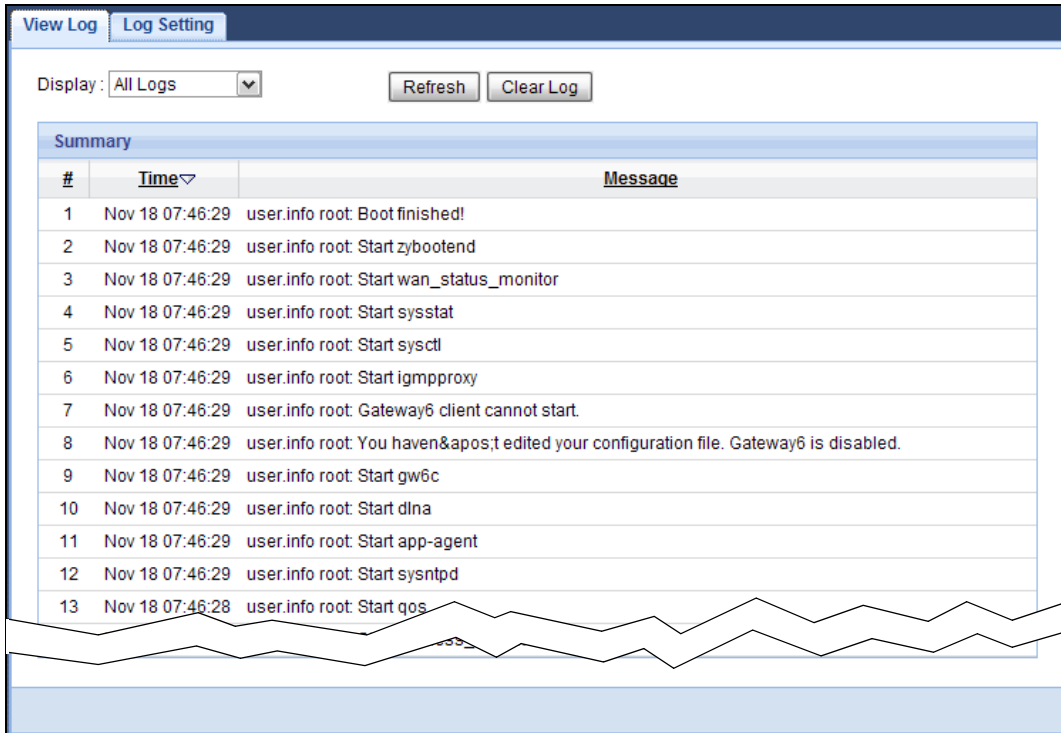

You can configure which logs to display in the **View Log** screen. Go to the **Log Setting** screen and select the logs you wish to display. Click **Apply** to save your settings. Click **Cancel** to start the screen afresh.

Figure 41 Log Settings

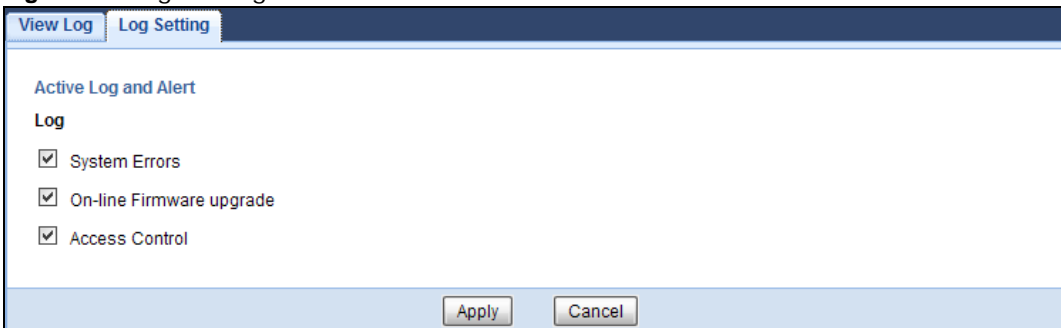

9.4 DHCP Table

DHCP (Dynamic Host Configuration Protocol, RFC 2131 and RFC 2132) allows individual clients to obtain TCP/IP configuration at start-up from a server. You can configure the NBG6616's LAN as a DHCP server or disable it. When configured as a server, the NBG6616 provides the TCP/IP configuration for the clients. If DHCP service is disabled, you must have another DHCP server on that network, or else the computer must be manually configured.

Click **Monitor > DHCP Table** or **Configuration > Network > DHCP Server > Client List**. Read-only information here relates to your DHCP status. The DHCP table shows current DHCP client

information (including **MAC Address**, and **IP Address**) of all network clients using the NBG6616's DHCP server.

Figure 42 Monitor > DHCP Table

#	Status	Host Name	IP Address	MAC Address	Reserve
1		twpc	192.168.1.46	00:21:85:0c:44:4b	<input type="checkbox"/>

The following table describes the labels in this screen.

Table 23 Monitor > DHCP Table

LABEL	DESCRIPTION
#	This is the index number of the host computer.
Status	This field displays whether the connection to the host computer is up (a yellow bulb) or down (a gray bulb).
Host Name	This field displays the computer host name.
IP Address	This field displays the IP address relative to the # field listed above.
MAC Address	This field shows the MAC address of the computer with the name in the Host Name field. Every Ethernet device has a unique MAC (Media Access Control) address which uniquely identifies a device. The MAC address is assigned at the factory and consists of six pairs of hexadecimal characters, for example, 00:A0:C5:00:00:02.
Reserve	Select this if you want to reserve the IP address for this specific MAC address.
Apply	Click Apply to save your changes back to the NBG6616.
Cancel	Click Cancel to reload the previous configuration for this screen.

9.5 Packet Statistics

Click **Monitor > Packet Statistics** or the **Packet Statistics (Details...)** hyperlink in the **Status** screen. Read-only information here includes port status, packet specific statistics and the "system up time". The **Poll Interval(s)** field is configurable and is used for refreshing the screen.

Figure 43 Monitor > Packet Statistics

Port	Status	TxPkts	RxPkts	Collisions	Tx B/s	Rx B/s	Up Time
WAN	Down	3565	0	0	138	0	2: 58: 56
LAN	Down	23991	0	0	696	0	2: 58: 56
WLAN 2.4G	300M	4672	4126	0	237	90	2: 58: 56
WLAN 5G	450M	45789	55346	0	5	6	2: 58: 56

System Up Time : 2: 58: 56

Poll Interval(s) :

The following table describes the labels in this screen.

Table 24 Monitor > Packet Statistics

LABEL	DESCRIPTION
Port	This is the NBG6616's interface type.
Status	For the LAN ports, this displays the port speed and duplex setting or Down when the line is disconnected. For the WAN port, it displays the port speed and duplex setting if you're using Ethernet encapsulation and Idle (line (ppp) idle), Dial (starting to trigger a call) and Drop (dropping a call) if you're using PPPoE encapsulation. This field displays Down when the line is disconnected. For the 2.4GHz or 5GHz WLAN, it displays the maximum transmission rate when the WLAN is enabled and Down when the WLAN is disabled.
TxPkts	This is the number of transmitted packets on this port.
RxPkts	This is the number of received packets on this port.
Collisions	This is the number of collisions on this port.
Tx B/s	This displays the transmission speed in bytes per second on this port.
Rx B/s	This displays the reception speed in bytes per second on this port.
Up Time	This is the total time the NBG6616 has been for each session.
System Up Time	This is the total time the NBG6616 has been on.
Poll Interval(s)	Enter the time interval in seconds for refreshing statistics in this field.
Set Interval	Click this button to apply the new poll interval you entered in the Poll Interval(s) field.
Stop	Click Stop to stop refreshing statistics.

9.6 WLAN Station Status

Click **Monitor > WLAN 2.4G/5G Station Status** or the **WLAN 2.4G/5G Station Status (Details...)** hyperlink in the **Status** screen. View the wireless stations that are currently associated to the NBG6616's 2.4GHz or 5GHz wireless network in the **Association List**. Association means that a wireless client (for example, your network or computer with a wireless network card) has connected successfully to the AP (or wireless router) using the same SSID, channel and security settings.

Figure 44 Monitor > WLAN Station Status

#	MAC Address	Association Time
1	00:22:FB:65:9A:F4	03:39:07 1970/01/01

The following table describes the labels in this screen.

Table 25 Monitor > WLAN Station Status

LABEL	DESCRIPTION
#	This is the index number of an associated wireless station.
MAC Address	This field displays the MAC address of an associated wireless station.
Association Time	This field displays the time a wireless station first associated with the NBG6616's WLAN.

10.1 Overview

This chapter discusses the NBG6616's **WAN** screens. Use these screens to configure your NBG6616 for Internet access.

A WAN (Wide Area Network) connection is an outside connection to another network or the Internet. It connects your private networks such as a LAN (Local Area Network) and other networks, so that a computer in one location can communicate with computers in other locations.

Figure 45 LAN and WAN

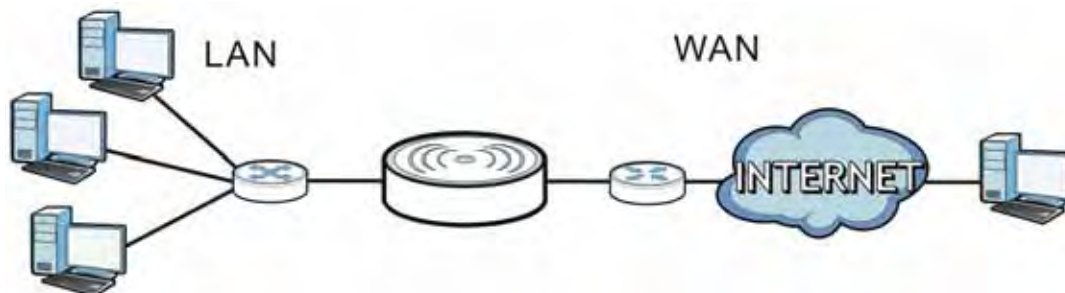

10.2 What You Can Do

- Use the **Internet Connection** screen to enter your ISP information and set how the computer acquires its IP, DNS and WAN MAC addresses ([Section 10.4 on page 76](#)).
- Use the **Advanced** screen to enable multicasting, configure Windows networking and bridge ([Section 10.5 on page 82](#)).

10.3 What You Need To Know

The information in this section can help you configure the screens for your WAN connection, as well as enable/disable some advanced features of your NBG6616.

10.3.1 Configuring Your Internet Connection

Encapsulation Method

Encapsulation is used to include data from an upper layer protocol into a lower layer protocol. To set up a WAN connection to the Internet, you need to use the same encapsulation method used by your ISP (Internet Service Provider). If your ISP offers a dial-up Internet connection using PPPoE (PPP over Ethernet) or PPTP (Point-to-Point Tunneling Protocol), they should also provide a username and password (and service name) for user authentication.

WAN IP Address

The WAN IP address is an IP address for the NBG6616, which makes it accessible from an outside network. It is used by the NBG6616 to communicate with other devices in other networks. It can be static (fixed) or dynamically assigned by the ISP each time the NBG6616 tries to access the Internet.

If your ISP assigns you a static WAN IP address, they should also assign you the subnet mask and DNS server IP address(es) (and a gateway IP address if you use the Ethernet or ENET ENCAP encapsulation method).

DNS Server Address Assignment

Use Domain Name System (DNS) to map a domain name to its corresponding IP address and vice versa, for instance, the IP address of www.zyxel.com is 204.217.0.2. The DNS server is extremely important because without it, you must know the IP address of a computer before you can access it.

The NBG6616 can get the DNS server addresses in the following ways.

- 1 The ISP tells you the DNS server addresses, usually in the form of an information sheet, when you sign up. If your ISP gives you DNS server addresses, manually enter them in the DNS server fields.
- 2 If your ISP dynamically assigns the DNS server IP addresses (along with the NBG6616's WAN IP address), set the DNS server fields to get the DNS server address from the ISP.

WAN MAC Address

The MAC address screen allows users to configure the WAN port's MAC address by either using the factory default or cloning the MAC address from a computer on your LAN. Choose **Factory Default** to select the factory assigned default MAC Address.

Otherwise, click **Clone the computer's MAC address - IP Address** and enter the IP address of the computer on the LAN whose MAC you are cloning. Once it is successfully configured, the address will be copied to configuration file. It is recommended that you clone the MAC address prior to hooking up the WAN Port.

Multicast

Traditionally, IP packets are transmitted in one of either two ways - Unicast (1 sender - 1 recipient) or Broadcast (1 sender - everybody on the network). Multicast delivers IP packets to a group of hosts on the network - not everybody and not just 1.

Figure 46 Multicast Example

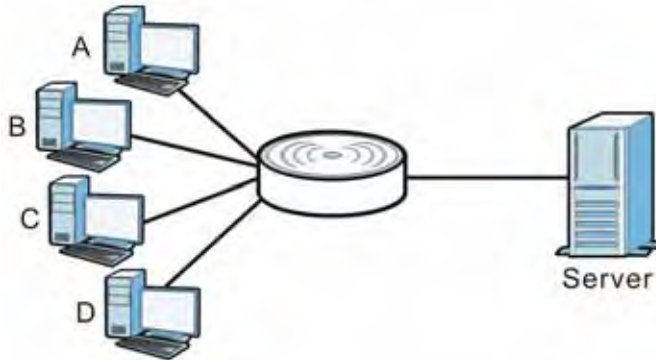

In the multicast example above, systems A and D comprise one multicast group. In multicasting, the server only needs to send one data stream and this is delivered to systems A and D.

IGMP (Internet Group Multicast Protocol) is a network-layer protocol used to establish membership in a multicast group - it is not used to carry user data. The NBG6616 supports both IGMP version 1 (**IGMP-v1**) and IGMP version 2 (**IGMP-v2**).

At start up, the NBG6616 queries all directly connected networks to gather group membership. After that, the NBG6616 periodically updates this information. IP multicasting can be enabled/disabled on the NBG6616 WAN interface in the Web Configurator (**WAN**). Select **None** to disable IP multicasting on these interfaces.

10.4 Internet Connection

Use this screen to change your NBG6616's Internet access settings. Click **Network** > **WAN** from the **Configuration** menu. The screen differs according to the encapsulation you choose.

10.4.1 IPoE Encapsulation

This screen displays when you select **IPoE** encapsulation.

Figure 47 Network > WAN > Internet Connection: IPoE Encapsulation (IPv4 Only)

The screenshot shows the 'Advanced' tab of the 'Internet Connection' configuration page. It is titled 'Internet Connection: IPoE Encapsulation (IPv4 Only)'. The configuration is organized into several sections:

- ISP Parameters for Internet Access:** Encapsulation is set to 'IPoE' and IPv4 / IPv6 is set to 'IPv4 Only'.
- IP Address:** Radio buttons for 'Obtain an IP Address Automatically' and 'Static IP Address'. Fields for IP Address, Subnet Mask, Gateway IP address, and MTU Size (set to 1500).
- 6RD:** 'Enable 6RD' is checked. Radio buttons for 'Automatically configured by DHCP' and 'Manually Configured'. Fields for Border Relay IPv4 Address, Service Provider IPv6 Prefix, Service Provider IPv6 Prefix length (set to 32), and IPv4 mask length (set to 0).
- DNS Server:** Fields for First, Second, and Third DNS Servers, each with a dropdown menu set to 'Obtained From ISP'.
- WAN MAC Address:** Radio buttons for 'Factory default', 'Clone the computer's MAC address - IP Address', and 'Set WAN MAC Address'.

Buttons for 'Apply' and 'Cancel' are located at the bottom of the form.

The following table describes the labels in this screen.

Table 26 Network > WAN > Internet Connection: IPoE Encapsulation

LABEL	DESCRIPTION
ISP Parameters for Internet Access	
Encapsulation	You must choose the IPoE option when the WAN port is used as a regular Ethernet.
IPv4 / IPv6	Select IPv4 Only if you want the NBG6616 to run IPv4 only. Select Dual Stack to allow the NBG6616 to run IPv4 and IPv6 at the same time. Select IPv6 Only if you want the NBG6616 to run IPv6 only.
IP Address	

Table 26 Network > WAN > Internet Connection: IPoE Encapsulation (continued)

LABEL	DESCRIPTION
Obtain an IP Address Automatically	Select this option If your ISP did not assign you a fixed IP address. This is the default selection.
Static IP Address	Select this option If the ISP assigned a fixed IP address.
IP Address	Enter your WAN IP address in this field if you selected Static IP Address .
Subnet Mask	Enter the Subnet Mask in this field.
Gateway IP Address	Enter a Gateway IP Address (if your ISP gave you one) in this field.
MTU Size	Enter the MTU (Maximum Transmission Unit) size for each packet. If a larger packet arrives, the NBG6616 divides it into smaller fragments.
<p>6RD</p> <p>Use IPv6 Rapid Deployment (6rd) when the local network uses IPv6 and the ISP has an IPv4 network. When the NBG6616 has an IPv4 WAN address and you set IPv6/IPv4 mode to IPv4 Only, you can enable 6rd to encapsulate IPv6 packets in IPv4 packets to cross the ISP's IPv4 network.</p> <p>The NBG6616 generates a global IPv6 prefix from its IPv4 WAN address and tunnels IPv6 traffic to the ISP's Border Relay router to connect to the native IPv6 Internet. The local network can also use IPv4 services. The NBG6616 uses its configured IPv4 WAN IP to route IPv4 traffic to the IPv4 Internet.</p> <p>This is available only when you select IPv4 Only in the IPv6/IPv4 field.</p>	
Enable 6RD	Enable IPv6 rapid deployment to tunnel IPv6 traffic from the local network through the ISP's IPv4 network.
Automatically configured by DHCP	Select this to have the NBG6616 detect the relay server's IP address automatically through DHCP.
Manually Configured	Select this if you have the IPv4 address of the relay server.
Border Relay IPv4 Address	Specify the relay server's IPv4 address.
Service Provider IPv6 Prefix	Enter an IPv6 prefix for tunneling IPv6 traffic to the ISP's Border Relay router and connecting to the native IPv6 Internet.
Service Provider IPv6 Prefix length	<p>Enter the IPv6 prefix length.</p> <p>An IPv6 prefix length specifies how many most significant bits (starting from the left) in the address compose the network address.</p>
IPv4 mask length	Enter the subnet mask number (1–32) for the IPv4 network.
DNS Server	
First DNS Server Second DNS Server Third DNS Server	<p>Select Obtained From ISP if your ISP dynamically assigns DNS server information (and the NBG6616's WAN IP address). The field to the right displays the (read-only) DNS server IP address that the ISP assigns.</p> <p>Select User-Defined if you have the IP address of a DNS server. Enter the DNS server's IP address in the field to the right.</p> <p>Select None if you do not want to configure DNS servers. If you do not configure a DNS server, you must know the IP address of a computer in order to access it.</p>
WAN MAC Address	The MAC address section allows users to configure the WAN port's MAC address by either using the NBG6616's MAC address, copying the MAC address from a computer on your LAN or manually entering a MAC address.
Factory default	Select Factory default to use the factory assigned default MAC Address.
Clone the computer's MAC address - IP Address	Select Clone the computer's MAC address - IP Address and enter the IP address of the computer on the LAN whose MAC you are cloning.

Table 26 Network > WAN > Internet Connection: IPoE Encapsulation (continued)

LABEL	DESCRIPTION
Set WAN MAC Address	Select this option and enter the MAC address you want to use.
IPv6 Address This is not available when you select IPv4 Only in the IPv6/IPv4 field.	
Obtain an IP Address Automatically	Select this if you want to obtain an IPv6 address from a DHCPv6 server.
Static IP Address	Select this if you have a fixed IPv6 address assigned by your ISP.
IPv6 Address	Enter the IPv6 address assigned by your ISP.
Prefix length	Enter the address prefix length to specify how many most significant bits in an IPv6 address compose the network address.
IPv6 Default Gateway	Enter the IP address of the next-hop gateway. The gateway is a router or switch on the same segment as your NBG6616's interface(s). The gateway helps forward packets to their destinations.
IPv6 DNS server This is not available when you select IPv4 Only in the IPv6/IPv4 field.	
Obtain IPv6 DNS info Automatically	Select this to have the NBG6616 get the IPv6 DNS server addresses from the ISP automatically.
Use the following Static DNS IPv6 Address	Select this to have the NBG6616 use the IPv6 DNS server addresses you configure manually.
IPv6 DNS Server	Enter the IPv6 DNS server address assigned by the ISP.
Apply	Click Apply to save your changes back to the NBG6616.
Cancel	Click Cancel to begin configuring this screen afresh.

10.4.2 PPPoE Encapsulation

The NBG6616 supports PPPoE (Point-to-Point Protocol over Ethernet). PPPoE is an IETF standard (RFC 2516) specifying how a personal computer (PC) interacts with a broadband modem (DSL, cable, wireless, etc.) connection. The **PPP over Ethernet** option is for a dial-up connection using PPPoE.

For the service provider, PPPoE offers an access and authentication method that works with existing access control systems (for example Radius).

One of the benefits of PPPoE is the ability to let you access one of multiple network services, a function known as dynamic service selection. This enables the service provider to easily create and offer new IP services for individuals.

Operationally, PPPoE saves significant effort for both you and the ISP or carrier, as it requires no specific configuration of the broadband modem at the customer site.

By implementing PPPoE directly on the NBG6616 (rather than individual computers), the computers on the LAN do not need PPPoE software installed, since the NBG6616 does that part of the task. Furthermore, with NAT, all of the LANs' computers will have access.

This screen displays when you select **PPPoE** encapsulation.

Figure 48 Network > WAN > Internet Connection: PPPoE Encapsulation (IPv4 Only)

Internet Connection
Advanced

ISP Parameters for Internet Access

Encapsulation : PPPoE ▼

IPv4 / IPv6 : IPv4 Only ▼

PPP Information

PPP Username :

PPP Password :

MTU Size : 1454

PPP Auto Connect :

IDLE Timeout [second] : 300

PPPoE Service Name :

WAN IP Address Assignment

Get automatically from ISP

Use Fixed IP Address

My WAN IP Address :

6RD

Enable 6RD

Manually Configured

Border Relay IPv4 Address:

Service Provider IPv6 Prefix:

Service Provider IPv6 Prefix length: 32 32~64

IPv4 mask length: 0 0~32

DNS Server

First DNS Server : Obtained From ISP ▼

Second DNS Server : Obtained From ISP ▼

Third DNS Server : Obtained From ISP ▼

WAN MAC Address

Factory default

Clone the computer's MAC address - IP Address

Set WAN MAC Address

Apply
Cancel

The following table describes the labels in this screen.

Table 27 Network > WAN > Internet Connection: PPPoE Encapsulation

LABEL	DESCRIPTION
ISP Parameters for Internet Access	
Encapsulation	Select PPPoE if you connect to your Internet via dial-up.
IPv4 / IPv6	Select IPv4 Only if you want the NBG6616 to run IPv4 only. Select Dual Stack to allow the NBG6616 to run IPv4 and IPv6 at the same time. Select IPv6 Only if you want the NBG6616 to run IPv6 only.
PPP Information	
PPP Username	Type the user name given to you by your ISP.
PPP Password	Type the password associated with the user name above.
MTU Size	Enter the Maximum Transmission Unit (MTU) or the largest packet size per frame that your NBG6616 can receive and process.
PPP Auto Connect	Select this option if you do not want the connection to time out.
Idle Timeout (second)	This value specifies the time in minutes that elapses before the router automatically disconnects from the PPPoE server.
PPPoE Service Name	Enter the PPPoE service name specified in the ISP account.
WAN IP Address Assignment	
Get automatically from ISP	Select this option If your ISP did not assign you a fixed IP address. This is the default selection.
Use Fixed IP Address	Select this option If the ISP assigned a fixed IP address.
My WAN IP Address	Enter your WAN IP address in this field if you selected Use Fixed IP Address .
<p>6RD</p> <p>Use IPv6 Rapid Deployment (6rd) when the local network uses IPv6 and the ISP has an IPv4 network. When the NBG6616 has an IPv4 WAN address and you set IPv6/IPv4 mode to IPv4 Only, you can enable 6rd to encapsulate IPv6 packets in IPv4 packets to cross the ISP's IPv4 network.</p> <p>The NBG6616 generates a global IPv6 prefix from its IPv4 WAN address and tunnels IPv6 traffic to the ISP's Border Relay router to connect to the native IPv6 Internet. The local network can also use IPv4 services. The NBG6616 uses its configured IPv4 WAN IP to route IPv4 traffic to the IPv4 Internet.</p> <p>This is available only when you select IPv4 Only in the IPv6/IPv4 field.</p>	
Enable 6RD	Enable IPv6 rapid deployment to tunnel IPv6 traffic from the local network through the ISP's IPv4 network.
Automatically configured by DHCP	Select this to have the NBG6616 detect the relay server's IP address automatically through DHCP.
Manually Configured	Select this if you have the IPv4 address of the relay server.
Border Relay IPv4 Address	Specify the relay server's IPv4 address.
Service Provider IPv6 Prefix	Enter an IPv6 prefix for tunneling IPv6 traffic to the ISP's Border Relay router and connecting to the native IPv6 Internet.
Service Provider IPv6 Prefix length	Enter the IPv6 prefix length. An IPv6 prefix length specifies how many most significant bits (starting from the left) in the address compose the network address.
IPv4 mask length	Enter the subnet mask number (1~32) for the IPv4 network.

Table 27 Network > WAN > Internet Connection: PPPoE Encapsulation (continued)

LABEL	DESCRIPTION
DNS Server	
First DNS Server	Select Obtained From ISP if your ISP dynamically assigns DNS server information (and the NBG6616's WAN IP address). The field to the right displays the (read-only) DNS server IP address that the ISP assigns.
Second DNS Server	
Third DNS Server	Select User-Defined if you have the IP address of a DNS server. Enter the DNS server's IP address in the field to the right. Select None if you do not want to configure DNS servers. If you do not configure a DNS server, you must know the IP address of a computer in order to access it.
WAN MAC Address	The MAC address section allows users to configure the WAN port's MAC address by using the NBG6616's MAC address, copying the MAC address from a computer on your LAN or manually entering a MAC address.
Factory default	Select Factory default to use the factory assigned default MAC Address.
Clone the computer's MAC address - IP Address	Select Clone the computer's MAC address - IP Address and enter the IP address of the computer on the LAN whose MAC you are cloning.
Set WAN MAC Address	Select this option and enter the MAC address you want to use.
IPv6 DNS server	
This is not available when you select IPv4 Only in the IPv6/IPv4 field.	
Obtain IPv6 DNS info Automatically	Select this to have the NBG6616 get the IPv6 DNS server addresses from the ISP automatically.
Use the following Static DNS IPv6 Address	Select this to have the NBG6616 use the IPv6 DNS server addresses you configure manually.
IPv6 DNS Server	Enter the IPv6 DNS server address assigned by the ISP.
Apply	Click Apply to save your changes back to the NBG6616.
Cancel	Click Cancel to begin configuring this screen afresh.

10.5 Advanced WAN Screen

To change your NBG6616's advanced WAN settings, click **Network > WAN > Advanced**. The screen appears as shown.

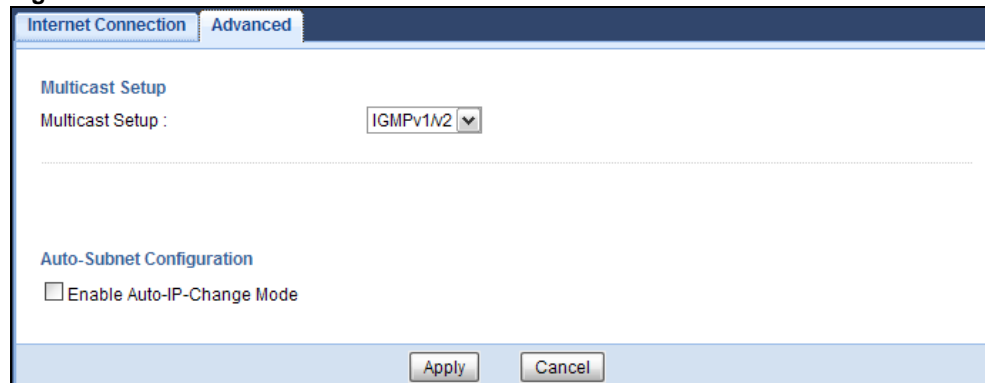
Figure 49 Network > WAN > Advanced

The following table describes the labels in this screen.

Table 28 Network > WAN > Advanced

LABEL	DESCRIPTION
Multicast Setup	
Multicast	Select IGMPv1/v2 to enable multicasting. This applies to traffic routed from the WAN to the LAN. Select None to disable this feature. This may cause incoming traffic to be dropped or sent to all connected network devices.
Auto-Subnet Configuration	
Enable Auto-IP-Change mode	Select this option to have the NBG6616 change its LAN IP address to 10.0.0.1 or 192.168.1.1 accordingly when the NBG6616 gets a dynamic WAN IP address in the same subnet as the LAN IP address 192.168.1.1 or 10.0.0.1. The NAT, DHCP server and firewall functions on the NBG6616 are still available in this mode.
Apply	Click Apply to save your changes back to the NBG6616.
Cancel	Click Cancel to begin configuring this screen afresh.

Wireless LAN

11.1 Overview

This chapter discusses how to configure the wireless network settings in your NBG6616. The NBG6616 is able to function both 2.4GHz and 5GHz network at the same time. You can have different wireless and wireless security settings for 2.4GHz and 5GHz wireless LANs. Click **Configuration > Network > Wireless LAN 2.4G** or **Wireless LAN 5G** to configure to do so.

See the appendices for more detailed information about wireless networks.

The following figure provides an example of a wireless network.

Figure 50 Example of a Wireless Network

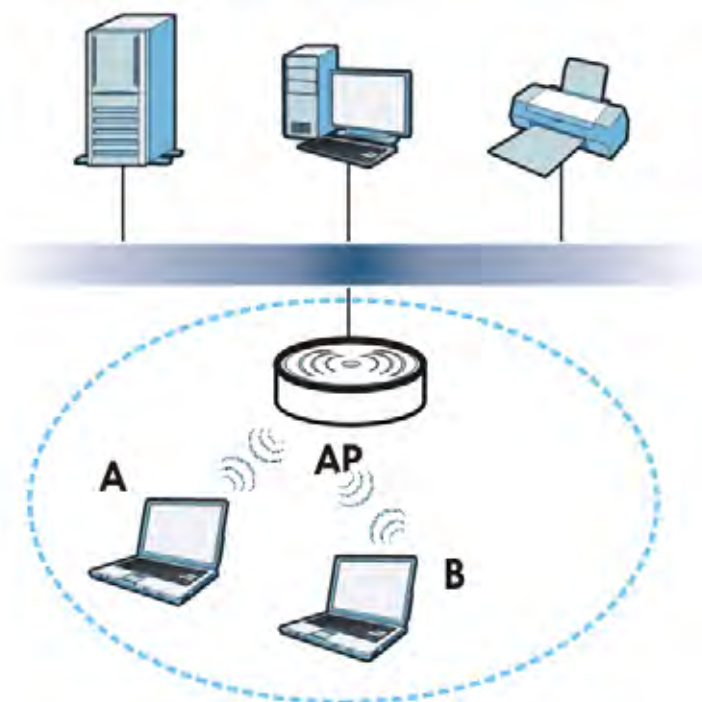

The wireless network is the part in the blue circle. In this wireless network, devices **A** and **B** are called wireless clients. The wireless clients use the access point (AP) to interact with other devices (such as the printer) or with the Internet. Your NBG6616 is the AP.

11.1.1 What You Can Do

- Use the **General** screen to turn the wireless connection on or off, set up wireless security between the NBG6616 and the wireless clients, and make other basic configuration changes ([Section 11.2 on page 89](#)).
- Use the **More AP** screen to set up multiple wireless networks on your NBG6616 ([Section 11.4 on page 97](#)).
- Use the **MAC Filter** screen to allow or deny wireless stations based on their MAC addresses from connecting to the NBG6616 ([Section 11.5 on page 100](#)).
- Use the **Advanced** screen to allow intra-BSS networking and set the RTS/CTS Threshold ([Section 11.6 on page 102](#)).
- Use the **QoS** screen to ensure Quality of Service (QoS) in your wireless network ([Section 11.7 on page 102](#)).
- Use the **WPS** screen to quickly set up a wireless network with strong security, without having to configure security settings manually ([Section 11.8 on page 103](#)).
- Use the **WPS Station** screen to add a wireless station using WPS ([Section 11.9 on page 105](#)).
- Use the **Scheduling** screen to set the times your wireless LAN is turned on and off ([Section 11.10 on page 105](#)).

11.1.2 What You Should Know

Every wireless network must follow these basic guidelines.

- Every wireless client in the same wireless network must use the same SSID.
The SSID is the name of the wireless network. It stands for Service Set IDentity.
- If two wireless networks overlap, they should use different channels.
Like radio stations or television channels, each wireless network uses a specific channel, or frequency, to send and receive information.
- Every wireless client in the same wireless network must use security compatible with the AP.
Security stops unauthorized devices from using the wireless network. It can also protect the information that is sent in the wireless network.

Wireless Security Overview

The following sections introduce different types of wireless security you can set up in the wireless network.

SSID

Normally, the AP acts like a beacon and regularly broadcasts the SSID in the area. You can hide the SSID instead, in which case the AP does not broadcast the SSID. In addition, you should change the default SSID to something that is difficult to guess.

This type of security is fairly weak, however, because there are ways for unauthorized devices to get the SSID. In addition, unauthorized devices can still see the information that is sent in the wireless network.

MAC Address Filter

Every wireless client has a unique identification number, called a MAC address.¹ A MAC address is usually written using twelve hexadecimal characters²; for example, 00A0C5000002 or 00:A0:C5:00:00:02. To get the MAC address for each wireless client, see the appropriate User's Guide or other documentation.

You can use the MAC address filter to tell the AP which wireless clients are allowed or not allowed to use the wireless network. If a wireless client is allowed to use the wireless network, it still has to have the correct settings (SSID, channel, and security). If a wireless client is not allowed to use the wireless network, it does not matter if it has the correct settings.

This type of security does not protect the information that is sent in the wireless network. Furthermore, there are ways for unauthorized devices to get the MAC address of an authorized wireless client. Then, they can use that MAC address to use the wireless network.

User Authentication

You can make every user log in to the wireless network before they can use it. This is called user authentication. However, every wireless client in the wireless network has to support IEEE 802.1x to do this.

For wireless networks, there are two typical places to store the user names and passwords for each user.

- In the AP: this feature is called a local user database or a local database.
- In a RADIUS server: this is a server used in businesses more than in homes.

If your AP does not provide a local user database and if you do not have a RADIUS server, you cannot set up user names and passwords for your users.

Unauthorized devices can still see the information that is sent in the wireless network, even if they cannot use the wireless network. Furthermore, there are ways for unauthorized wireless users to get a valid user name and password. Then, they can use that user name and password to use the wireless network.

Local user databases also have an additional limitation that is explained in the next section.

Encryption

Wireless networks can use encryption to protect the information that is sent in the wireless network. Encryption is like a secret code. If you do not know the secret code, you cannot understand the message.

1. Some wireless devices, such as scanners, can detect wireless networks but cannot use wireless networks. These kinds of wireless devices might not have MAC addresses.

2. Hexadecimal characters are 0, 1, 2, 3, 4, 5, 6, 7, 8, 9, A, B, C, D, E, and F.

The types of encryption you can choose depend on the type of user authentication. (See [page 86](#) for information about this.)

Table 29 Types of Encryption for Each Type of Authentication

	NO AUTHENTICATION	RADIUS SERVER
Weakest  Strongest	No Security	WPA
	Static WEP	
	WPA-PSK	
	WPA2-PSK	WPA2

For example, if the wireless network has a RADIUS server, you can choose **WPA** or **WPA2**. If users do not log in to the wireless network, you can choose no encryption, **Static WEP**, **WPA-PSK**, or **WPA2-PSK**.

Usually, you should set up the strongest encryption that every wireless client in the wireless network supports. For example, suppose the AP does not have a local user database, and you do not have a RADIUS server. Therefore, there is no user authentication. Suppose the wireless network has two wireless clients. Device A only supports WEP, and device B supports WEP and WPA. Therefore, you should set up **Static WEP** in the wireless network.

Note: It is recommended that wireless networks use **WPA-PSK**, **WPA**, or stronger encryption. IEEE 802.1x and WEP encryption are better than none at all, but it is still possible for unauthorized devices to figure out the original information pretty quickly.

Note: It is not possible to use **WPA-PSK**, **WPA** or stronger encryption with a local user database. In this case, it is better to set up stronger encryption with no authentication than to set up weaker encryption with the local user database.

When you select **WPA2** or **WPA2-PSK** in your NBG6616, you can also select an option (**WPA/WPA-PSK Compatible**) to support WPA/WPA-PSK as well. In this case, if some wireless clients support WPA and some support WPA2, you should set up **WPA2-PSK** or **WPA2** (depending on the type of wireless network login) and select the **WPA/WPA-PSK Compatible** option in the NBG6616.

Many types of encryption use a key to protect the information in the wireless network. The longer the key, the stronger the encryption. Every wireless client in the wireless network must have the same key.

Guest WLAN

Guest WLAN allows you to set up a wireless network where users can access to Internet via the NBG6616 (**Z**), but not other networks connected to the **Z**. In the following figure, a guest user can access the Internet from the guest wireless network **A** via **Z** but not the home or company network **N**.

Note: The home or company network **N** and Guest WLAN network are independent networks.

Note: Only Router mode supports guest WLAN.

Figure 51 Guest Wireless LAN Network

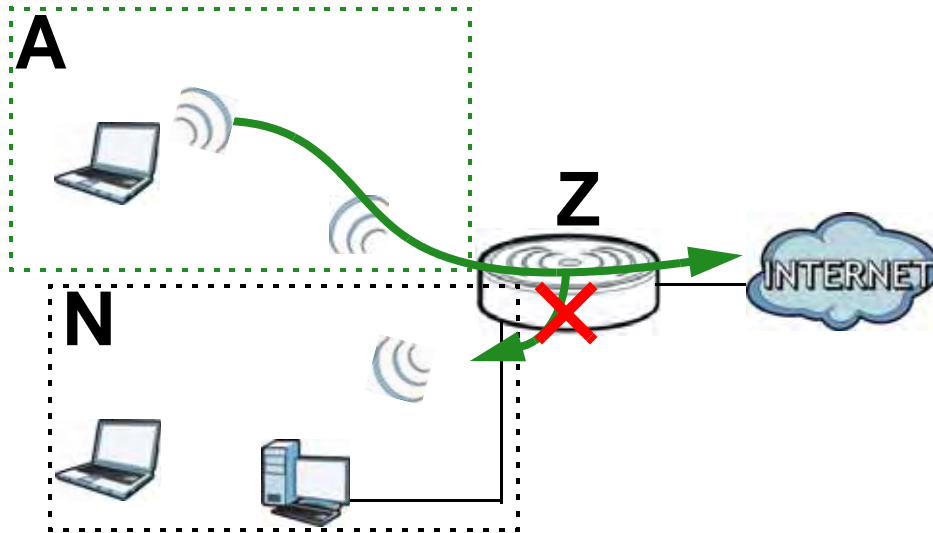

Guest WLAN Bandwidth

The Guest WLAN Bandwidth function allows you to restrict the maximum bandwidth for the guest wireless network. Additionally, you can also define bandwidth for your home or office network. An example is shown next to define maximum bandwidth for your networks (A is Guest WLAN and N is home or company network.)

Figure 52 Example: Bandwidth for Different Networks

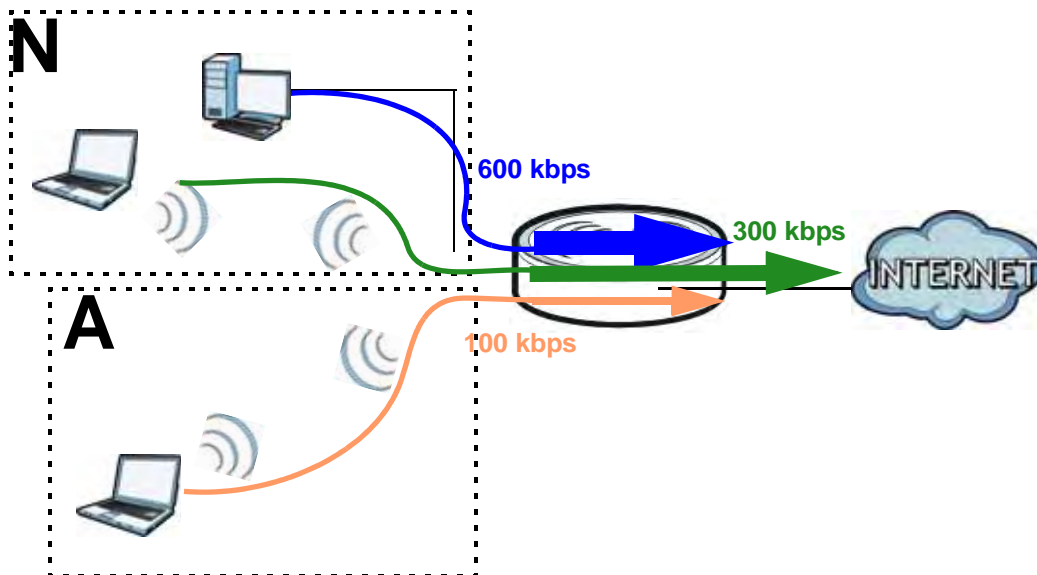

WPS

WiFi Protected Setup (WPS) is an industry standard specification, defined by the WiFi Alliance. WPS allows you to quickly set up a wireless network with strong security, without having to configure security settings manually. Depending on the devices in your network, you can either press a button (on the device itself, or in its configuration utility) or enter a PIN (Personal Identification

Number) in the devices. Then, they connect and set up a secure network by themselves. See how to set up a secure wireless network using WPS in the [Section 8.2 on page 56](#).

11.2 General Wireless LAN Screen

Use this screen to configure the SSID and wireless security of the wireless LAN.

Note: If you are configuring the NBG6616 from a computer connected to the wireless LAN and you change the NBG6616's SSID, channel or security settings, you will lose your wireless connection when you press **Apply** to confirm. You must then change the wireless settings of your computer to match the NBG6616's new settings.

Click **Network > Wireless LAN 2.4G/5G** to open the **General** screen.

Figure 53 Network > Wireless LAN 2.4G/5G > General

The following table describes the general wireless LAN labels in this screen.

Table 30 Network > Wireless LAN 2.4G/5G > General

LABEL	DESCRIPTION
Wireless LAN	Select Enable to activate the 2.4GHz and/or 5GHz wireless LAN. Select Disable to turn it off. You can enable or disable both 2.4GHz and 5GHz wireless LANs by using the WIFI button located on the back panel of the NBG6616.
Name (SSID)	The SSID (Service Set IDentity) identifies the Service Set with which a wireless client is associated. Enter a descriptive name (up to 32 printable characters found on a typical English language keyboard) for the wireless LAN.
Hide SSID	Select this check box to hide the SSID in the outgoing beacon frame so a station cannot obtain the SSID through scanning using a site survey tool.

Table 30 Network > Wireless LAN 2.4G/5G > General (continued)

LABEL	DESCRIPTION
Channel Selection	<p>Set the operating frequency/channel depending on your particular region.</p> <p>Select a channel from the drop-down list box. The options vary depending on the frequency band and the country you are in.</p> <p>Refer to the Connection Wizard chapter for more information on channels. This option is only available if Auto Channel Selection is disabled.</p>
Auto Channel Selection	<p>Select this check box for the NBG6616 to automatically choose the channel with the least interference. Deselect this check box if you wish to manually select the channel using the Channel Selection field.</p>
Operating Channel	<p>This displays the channel the NBG6616 is currently using.</p>
Channel Width	<p>Select the wireless channel width used by NBG6616.</p> <p>A standard 20MHz channel offers transfer speeds of up to 144Mbps (2.4GHz) or 217Mbps (5GHZ) whereas a 40MHz channel uses two standard channels and offers speeds of up to 300Mbps (2.4GHz) or 450Mbps (5GHZ).</p> <p>Because not all devices support 40 MHz channels, select Auto 20/40MHz to allow the NBG6616 to adjust the channel bandwidth automatically.</p> <p>40MHz (channel bonding or dual channel) bonds two adjacent radio channels to increase throughput. The wireless clients must also support 40 MHz. It is often better to use the 20 MHz setting in a location where the environment hinders the wireless signal.</p> <p>Select 20MHz if you want to lessen radio interference with other wireless devices in your neighborhood or the wireless clients do not support channel bonding.</p>
802.11 Mode	<p>If you are in the Wireless LAN 2.4G > General screen, you can select from the following:</p> <ul style="list-style-type: none"> • 802.11b: allows either IEEE 802.11b or IEEE 802.11g compliant WLAN devices to associate with the NBG6616. In this mode, all wireless devices can only transmit at the data rates supported by IEEE 802.11b. • 802.11g: allows IEEE 802.11g compliant WLAN devices to associate with the Device. IEEE 802.11b compliant WLAN devices can associate with the NBG6616 only when they use the short preamble type. • 802.11bg: allows either IEEE 802.11b or IEEE 802.11g compliant WLAN devices to associate with the NBG6616. The NBG6616 adjusts the transmission rate automatically according to the wireless standard supported by the wireless devices. • 802.11n: allows IEEE 802.11n compliant WLAN devices to associate with the NBG6616. This can increase transmission rates, although IEEE 802.11b or IEEE 802.11g clients will not be able to connect to the NBG6616. • 802.11gn: allows either IEEE 802.11g or IEEE 802.11n compliant WLAN devices to associate with the NBG6616. The transmission rate of your NBG6616 might be reduced. • 802.11 bgn: allows IEEE802.11b, IEEE802.11g and IEEE802.11n compliant WLAN devices to associate with the NBG6616. The transmission rate of your NBG6616 might be reduced. <p>If you are in the Wireless LAN 5G > General screen, you can select from the following:</p> <ul style="list-style-type: none"> • 802.11a: allows only IEEE 802.11a compliant WLAN devices to associate with the NBG6616. • 802.11an: allows both IEEE802.11n and IEEE802.11a compliant WLAN devices to associate with the NBG6616. The transmission rate of your NBG6616 might be reduced.

Table 30 Network > Wireless LAN 2.4G/5G > General (continued)

LABEL	DESCRIPTION
Security Mode	Select Static WEP , WPA-PSK , WPA , WPA2-PSK or WPA2 to add security on this wireless network. The wireless clients which want to associate to this network must have same wireless security settings as this device. After you select to use a security, additional options appears in this screen. See Section 11.3 on page 91 for detailed information on different security modes. Or you can select No Security to allow any client to associate this network without authentication. Note: If the WPS function is enabled (default), only No Security and WPA2-PSK are available in this field.
Apply	Click Apply to save your changes back to the NBG6616.
Cancel	Click Cancel to reload the previous configuration for this screen.

See the rest of this chapter for information on the other labels in this screen.

11.3 Wireless Security

The screen varies depending on what you select in the **Security Mode** field.

11.3.1 No Security

Select **No Security** to allow wireless clients to communicate with the access points without any data encryption.

Note: If you do not enable any wireless security on your NBG6616, your network is accessible to any wireless networking device that is within range.

Figure 54 Network > Wireless LAN 2.4G/5G > General: No Security

The screenshot shows the configuration page for the wireless LAN. The 'General' tab is selected. Under 'Wireless Setup', 'Wireless LAN' is enabled. The SSID is 'ZyXEL'. 'Hide SSID' is unchecked. 'Channel Selection' is 'Channel-1 2412MHz' with 'Auto Channel Selection' checked. 'Operating Channel' is 'Channel-'. 'Channel Width' is 'Auto 20/40 MHz'. '802.11 Mode' is '802.11bgn'. Under the 'Security' section, 'Security Mode' is set to 'No Security'. A note at the bottom states: 'Note: No Security and WPA2-PSK can be configured when WPS enabled.' 'Apply' and 'Cancel' buttons are at the bottom.

The following table describes the labels in this screen.

Table 31 Network > Wireless LAN 2.4G/5G > General: No Security

LABEL	DESCRIPTION
Security Mode	Choose No Security from the drop-down list box.
Apply	Click Apply to save your changes back to the NBG6616.
Cancel	Click Cancel to reload the previous configuration for this screen.

11.3.2 WEP Encryption

WEP encryption scrambles the data transmitted between the wireless stations and the access points to keep network communications private. It encrypts unicast and multicast communications in a network. Both the wireless stations and the access points must use the same WEP key.

Your NBG6616 allows you to configure up to four 64-bit or 128-bit WEP keys but only one key can be enabled at any one time.

Select **Static WEP** from the **Security Mode** list.

Figure 55 Network > Wireless LAN 2.4G/5G > General: Static WEP

The following table describes the wireless LAN security labels in this screen.

Table 32 Network > Wireless LAN 2.4G/5G > General: Static WEP

LABEL	DESCRIPTION
Security Mode	Select Static WEP to enable data encryption.
PassPhrase	Enter a Passphrase (up to 26 printable characters) and click Generate . A passphrase functions like a password. In WEP security mode, it is further converted by the NBG6616 into a complicated string that is referred to as the "key". This key is requested from all devices wishing to connect to a wireless network.
WEP Encryption	Select 64-bits or 128-bits . This dictates the length of the security key that the network is going to use.
Authentication Method	Select Auto or Shared Key from the drop-down list box. This field specifies whether the wireless clients have to provide the WEP key to login to the wireless client. Keep this setting at Auto unless you want to force a key verification before communication between the wireless client and the NBG6616 occurs. Select Shared Key to force the clients to provide the WEP key prior to communication.

Table 32 Network > Wireless LAN 2.4G/5G > General: Static WEP (continued)

LABEL	DESCRIPTION
ASCII	Select this option in order to enter ASCII characters as WEP key.
Hex	Select this option in order to enter hexadecimal characters as a WEP key. The preceding "0x", that identifies a hexadecimal key, is entered automatically.
Key 1 to Key 4	The WEP keys are used to encrypt data. Both the NBG6616 and the wireless stations must use the same WEP key for data transmission. If you chose 64-bits , then enter any 5 ASCII characters or 10 hexadecimal characters ("0-9", "A-F"). If you chose 128-bits , then enter 13 ASCII characters or 26 hexadecimal characters ("0-9", "A-F"). You must configure at least one key, only one key can be activated at any one time. The default key is key 1.
Apply	Click Apply to save your changes back to the NBG6616.
Cancel	Click Cancel to reload the previous configuration for this screen.

11.3.3 WPA-PSK/WPA2-PSK

Select **WPA-PSK** or **WPA2-PSK** from the **Security Mode** list.

Figure 56 Network > Wireless LAN 2.4G/5G > General: WPA-PSK/WPA2-PSK

The screenshot shows the configuration page for Wireless LAN 2.4G/5G. The 'General' tab is selected. Under 'Wireless Setup', 'Wireless LAN' is enabled. The SSID is 'ZyXEL'. Channel selection is set to 'Channel-1 2412MHz' with 'Auto Channel Selection' checked. Channel width is 'Auto 20/40 MHz' and 802.11 mode is '802.11bgn'. Under 'Security', 'Security Mode' is set to 'WPA2-PSK'. 'WPA-PSK Compatible' is checked. The pre-shared key is '9R7KV4ECYF9VA' and the group key update timer is 3600 seconds. A note states: 'Note: No Security and WPA2-PSK can be configured when WPS enabled.' Buttons for 'Apply' and 'Cancel' are at the bottom.

The following table describes the labels in this screen.

Table 33 Network > Wireless LAN 2.4G/5G > General: WPA-PSK/WPA2-PSK

LABEL	DESCRIPTION
Security Mode	Select WPA-PSK or WPA2-PSK to enable data encryption.
WPA-PSK Compatible	This field appears when you choose WPA2-PSK as the Security Mode . Check this field to allow wireless devices using WPA-PSK security mode to connect to your NBG6616.
Pre-Shared Key	WPA-PSK/WPA2-PSK uses a simple common password for authentication. Type a pre-shared key from 8 to 63 case-sensitive keyboard characters.
Group Key Update Timer	The Group Key Update Timer is the rate at which the AP sends a new group key out to all clients. The default is 3600 seconds (60 minutes).
Apply	Click Apply to save your changes back to the NBG6616.
Cancel	Click Cancel to reload the previous configuration for this screen.

11.3.4 WPA/WPA2

Select **WPA** or **WPA2** from the **Security Mode** list.

Note: WPA or WPA2 is not available if you enable WPS before you configure WPA or WPA2 in the **Wireless LAN 2.4G/5G > General** screen.

Figure 57 Network > Wireless LAN 2.4G/5G > General: WPA/WPA2

The following table describes the labels in this screen.

Table 34 Network > Wireless LAN 2.4G/5G > General: WPA/WPA2

LABEL	DESCRIPTION
Security Mode	Select WPA or WPA2 to enable data encryption.
WPA Compatible	This check box is available only when you select WPA2-PSK or WPA2 in the Security Mode field. Select the check box to have both WPA2 and WPA wireless clients be able to communicate with the NBG6616 even when the NBG6616 is using WPA2-PSK or WPA2.
Group Key Update Timer	The Group Key Update Timer is the rate at which the AP (if using WPA-PSK/WPA2-PSK key management) or RADIUS server (if using WPA/WPA2 key management) sends a new group key out to all clients. The re-keying process is the WPA/WPA2 equivalent of automatically changing the WEP key for an AP and all stations in a WLAN on a periodic basis. Setting of the Group Key Update Timer is also supported in WPA-PSK/WPA2-PSK mode.
PMK Cache Period	This field is available only when you select WPA2 . Specify how often wireless clients have to resend usernames and passwords in order to stay connected. Enter a time interval between 10 and 999999 minutes. Note: If wireless client authentication is done using a RADIUS server, the reauthentication timer on the RADIUS server has priority.

Table 34 Network > Wireless LAN 2.4G/5G > General: WPA/WPA2 (continued)

LABEL	DESCRIPTION
Pre-Authentication	This field is available only when you select WPA2 . Pre-authentication enables fast roaming by allowing the wireless client (already connecting to an AP) to perform IEEE 802.1x authentication with another AP before connecting to it. Select Enable to turn on preauthentication in WAP2. Otherwise, select Disable .
Authentication Server	
IP Address	Enter the IP address of the external authentication server in dotted decimal notation.
Port Number	Enter the port number of the external authentication server. You need not change this value unless your network administrator instructs you to do so with additional information.
Shared Secret	Enter a password (up to 127 alphanumeric characters) as the key to be shared between the external authentication server and the NBG6616. The key must be the same on the external authentication server and your NBG6616. The key is not sent over the network.
Session Timeout	The NBG6616 automatically disconnects a wireless client from the wireless and wired networks after a period of inactivity. The wireless client needs to send the username and password again before it can use the wireless and wired networks again. Some wireless clients may prompt users for a username and password; other clients may use saved login credentials. In either case, there is usually a short delay while the wireless client logs in to the wireless network again. Enter the time in seconds from 0 to 999999.
Apply	Click Apply to save your changes back to the NBG6616.
Cancel	Click Cancel to reload the previous configuration for this screen.

11.4 More AP Screen

This screen allows you to enable and configure multiple wireless networks and guest wireless network settings on the NBG6616.

You can configure up to four SSIDs to enable multiple BSSs (Basic Service Sets) on the NBG6616. This allows you to use one access point to provide several BSSs simultaneously. You can then assign varying security types to different SSIDs. Wireless clients can use different SSIDs to associate with the same access point.

Click **Network > Wireless LAN 2.4G/5G > More AP**. The following screen displays.

Figure 58 Network > Wireless LAN 2.4G/5G > More AP

#	Status	SSID	Security	Edit
1		ZyXEL_SSID1	No Security	
2		ZyXEL_SSID2	No Security	
3		ZyXEL_SSID3	No Security	

The following table describes the labels in this screen.

Table 35 Network > Wireless LAN 2.4G/5G > More AP

LABEL	DESCRIPTION
#	This is the index number of each SSID profile.
Status	This shows whether the SSID profile is active (a yellow bulb) or not (a gray bulb).
SSID	An SSID profile is the set of parameters relating to one of the NBG6616's BSSs. The SSID (Service Set Identifier) identifies the Service Set with which a wireless device is associated. This field displays the name of the wireless profile on the network. When a wireless client scans for an AP to associate with, this is the name that is broadcast and seen in the wireless client utility.
Security	This field indicates the security mode of the SSID profile.
Edit	Click the Edit icon to configure the SSID profile.

11.4.1 More AP Edit

Use this screen to edit an SSID profile. Click the **Edit** icon next to an SSID in the **More AP** screen. The following screen displays.

Figure 59 Network > Wireless LAN 2.4G/5G > More AP: Edit

Wireless Setup

Active :

Name (SSID) :

Hide SSID

Intra-BSS Traffic

WMM QoS

Security

Security Mode :

No Security, WPA-PSK and WPA2-PSK can be configured when WPS enabled.

Figure 60 Network > Wireless LAN 2.4G/5G > More AP: Edit (the last SSID)

Wireless Setup

Active :

Name (SSID) :

Hide SSID

Intra-BSS Traffic

WMM QoS

Enable Guest WLAN

IP Address :

IP Subnet Mask :

Enable Bandwidth Management for Guest WLAN

Maximum Bandwidth (kbps)

Security

Security Mode :

No Security and WPA2-PSK can be configured when WPS enabled.

The following table describes the labels in this screen.

Table 36 Network > Wireless LAN 2.4G/5G > More AP: Edit

LABEL	DESCRIPTION
Active	Select this to activate the SSID profile.
Name (SSID)	The SSID (Service Set IDentity) identifies the Service Set with which a wireless client is associated. Enter a descriptive name (up to 32 printable characters found on a typical English language keyboard) for the wireless LAN.
Hide SSID	Select this check box to hide the SSID in the outgoing beacon frame so a station cannot obtain the SSID through scanning using a site survey tool.
Intra-BSS Traffic	A Basic Service Set (BSS) exists when all communications between wireless clients or between a wireless client and a wired network client go through one access point (AP). Intra-BSS traffic is traffic between wireless clients in the BSS. When Intra-BSS is enabled, wireless clients can access the wired network and communicate with each other. When Intra-BSS is disabled, wireless clients can still access the wired network but cannot communicate with each other.
WMM QoS	Check this to have the NBG6616 automatically give a service a priority level according to the ToS value in the IP header of packets it sends. WMM QoS (Wifi MultiMedia Quality of Service) gives high priority to voice and video, which makes them run more smoothly.
Enable Guest WLAN	Select the check box to activate guest wireless LAN. This is available only for the last SSID on the NBG6616. Note: Only Router mode supports guest WLAN. AP mode doesn't support guest WLAN.
IP Address	Type an IP address for the devices on the Guest WLAN using this as the gateway IP address.
IP Subnet Mask	Type the subnet mask for the guest wireless LAN.

Table 36 Network > Wireless LAN 2.4G/5G > More AP: Edit (continued)

LABEL	DESCRIPTION
Enable Bandwidth Management for Guest WLAN	Select this to turn on bandwidth management for the Guest WLAN network.
Maximum Bandwidth	Enter a number to specify maximum bandwidth the Guest WLAN network can use.
Security Mode	<p>Select Static WEP, WPA-PSK, WPA, WPA2-PSK or WPA2 to add security on this wireless network. The wireless clients which want to associate to this network must have same wireless security settings as this device. After you select to use a security, additional options appears in this screen. See Section 11.3 on page 91 for detailed information on different security modes. Or you can select No Security to allow any client to associate this network without authentication.</p> <p>Note: If the WPS function is enabled (default), only No Security and WPA2-PSK are available in this field.</p>
Apply	Click Apply to save your changes back to the NBG6616.
Cancel	Click Cancel to reload the previous configuration for this screen.

11.5 MAC Filter Screen

The MAC filter screen allows you to configure the NBG6616 to give exclusive access to devices (**Allow**) or exclude devices from accessing the NBG6616 (**Deny**). Every Ethernet device has a unique MAC (Media Access Control) address. The MAC address is assigned at the factory and consists of six pairs of hexadecimal characters, for example, 00:A0:C5:00:00:02. You need to know the MAC address of the devices to configure this screen.

To change your NBG6616's MAC filter settings, click **Network > Wireless LAN 2.4G/5G > MAC Filter**. The screen appears as shown.

Figure 61 Network > Wireless LAN 2.4G/5G > MAC Filter

SSID Select : ZyXELCCDD10

MAC Address Filter : Enable Disable

Filter Action : Allow Deny

MAC Filter Summary			
Set	MAC Address	Set	MAC Address
1	00:00:00:00:00:00	17	00:00:00:00:00:00
2	00:00:00:00:00:00	18	00:00:00:00:00:00
3	00:00:00:00:00:00	19	00:00:00:00:00:00
4	00:00:00:00:00:00	20	00:00:00:00:00:00
5	00:00:00:00:00:00	21	00:00:00:00:00:00
6	00:00:00:00:00:00	22	00:00:00:00:00:00
7	00:00:00:00:00:00	23	00:00:00:00:00:00
8	00:00:00:00:00:00	24	00:00:00:00:00:00
9	00:00:00:00:00:00	25	00:00:00:00:00:00
10	00:00:00:00:00:00	26	00:00:00:00:00:00
11	00:00:00:00:00:00	27	00:00:00:00:00:00
12	00:00:00:00:00:00	28	00:00:00:00:00:00
13	00:00:00:00:00:00	29	00:00:00:00:00:00
14	00:00:00:00:00:00	30	00:00:00:00:00:00
15	00:00:00:00:00:00	31	00:00:00:00:00:00
16	00:00:00:00:00:00	32	00:00:00:00:00:00

Apply Cancel

The following table describes the labels in this menu.

Table 37 Network > Wireless LAN 2.4G/5G > MAC Filter

LABEL	DESCRIPTION
SSID Select	Select the SSID for which you want to configure MAC filtering.
MAC Address Filter	Select to turn on (Enable) or off (Disable) MAC address filtering.
Filter Action	Define the filter action for the list of MAC addresses in the MAC Filter Summary table. Select Allow to permit access to the NBG6616, MAC addresses not listed will be denied access to the NBG6616. Select Deny to block access to the NBG6616, MAC addresses not listed will be allowed to access the NBG6616.
MAC Filter Summary	
Set	This is the index number of the MAC address.
MAC Address	Enter the MAC address of the wireless station that are allowed or denied access to the NBG6616.
Apply	Click Apply to save your changes back to the NBG6616.
Cancel	Click Cancel to reload the previous configuration for this screen.

11.6 Wireless LAN Advanced Screen

Use this screen to allow wireless advanced features, such as the output power, RTS/CTS Threshold settings.

Click **Network > Wireless LAN 2.4G/5G > Advanced**. The screen appears as shown.

Figure 62 Network > Wireless LAN 2.4G/5G > Advanced

The following table describes the labels in this screen.

Table 38 Network > Wireless LAN 2.4G/5G > Advanced

LABEL	DESCRIPTION
RTS/CTS Threshold	Data with its frame size larger than this value will perform the RTS (Request To Send)/CTS (Clear To Send) handshake. This field is not configurable and the NBG6616 automatically changes to use the maximum value if you select 802.11n , 802.11an , 802.11gn or 802.11bgn in the Wireless LAN 2.4G/5G > General screen.
Fragmentation Threshold	The threshold (number of bytes) for the fragmentation boundary for directed messages. It is the maximum data fragment size that can be sent. This field is not configurable and the NBG6616 automatically changes to use the maximum value if you select 802.11n , 802.11an , 802.11gn or 802.11bgn in the Wireless LAN 2.4G/5G > General screen.
Intra-BSS Traffic	A Basic Service Set (BSS) exists when all communications between wireless clients or between a wireless client and a wired network client go through one access point (AP). Intra-BSS traffic is traffic between wireless clients in the BSS. When Intra-BSS is enabled, wireless clients can access the wired network and communicate with each other. When Intra-BSS is disabled, wireless clients can still access the wired network but cannot communicate with each other.
Tx Power	Set the output power of the NBG6616 in this field. If there is a high density of APs in an area, decrease the output power of the NBG6616 to reduce interference with other APs. Select one of the following 100% , 90% , 75% , 50% , 25% or 10% .
Apply	Click Apply to save your changes back to the NBG6616.
Cancel	Click Cancel to reload the previous configuration for this screen.

11.7 Quality of Service (QoS) Screen

The QoS screen allows you to automatically give a service (such as VoIP and video) a priority level.

Click **Network > Wireless LAN 2.4G/5G > QoS**. The following screen appears.

Figure 63 Network > Wireless LAN 2.4G/5G > QoS

The following table describes the labels in this screen.

Table 39 Network > Wireless LAN 2.4G/5G > QoS

LABEL	DESCRIPTION
WMM QoS	Select Enable to have the NBG6616 automatically give a service a priority level according to the ToS value in the IP header of packets it sends. WMM QoS (Wifi MultiMedia Quality of Service) gives high priority to voice and video, which makes them run more smoothly. This field is not configurable and the NBG6616 automatically enables WMM QoS if you select 802.11n , 802.11an , 802.11gn or 802.11bgn in the Wireless LAN 24G/5G > General screen.
Apply	Click Apply to save your changes to the NBG6616.
Cancel	Click Cancel to reload the previous configuration for this screen.

11.8 WPS Screen

Use this screen to enable/disable WPS, view or generate a new PIN number and check current WPS status. To open this screen, click **Network > Wireless LAN 2.4G/5G > WPS**.

Note: With WPS, wireless clients can only connect to the wireless network using the first SSID on the NBG6616.

Figure 64 Network > Wireless LAN 2.4G/5G > WPS

The following table describes the labels in this screen.

Table 40 Network > Wireless LAN 2.4G/5G > WPS

LABEL	DESCRIPTION
WPS Setup	
WPS	Select Enable to turn on the WPS feature. Otherwise, select Disable .
PIN Code	Select Enable and click Apply to allow the PIN Configuration method. If you select Disable , you cannot create a new PIN number.
PIN Number	This is the WPS PIN (Personal Identification Number) of the NBG6616. Enter this PIN in the configuration utility of the device you want to connect to the NBG6616 using WPS. The PIN is not necessary when you use WPS push-button method. Click Generate to generate a new PIN number.
WPS Status	
Status	This displays Configured when the NBG6616 has connected to a wireless network using WPS or when WPS Enable is selected and wireless or wireless security settings have been changed. The current wireless and wireless security settings also appear in the screen. This displays Unconfigured if WPS is disabled and there are no wireless or wireless security changes on the NBG6616 or you click Release Configuration to remove the configured wireless and wireless security settings.
Release Configuration	This button is only available when the WPS status displays Configured . Click this button to remove all configured wireless and wireless security settings for WPS connections on the NBG6616.
802.11 Mode	This is the 802.11 mode used. Only compliant WLAN devices can associate with the NBG6616.
SSID	This is the name of the wireless network (the NBG6616's first SSID).
Security	This is the type of wireless security employed by the network.

Table 40 Network > Wireless LAN 2.4G/5G > WPS (continued)

LABEL	DESCRIPTION
Apply	Click Apply to save your changes back to the NBG6616.
Cancel	Click Cancel to reload the previous configuration for this screen.

11.9 WPS Station Screen

Use this screen when you want to add a wireless station using WPS. To open this screen, click **Network > Wireless LAN 2.4G/5G > WPS Station** tab.

Note: After you click **Push Button** on this screen, you have to press a similar button in the wireless station utility within 2 minutes. To add the second wireless station, you have to press these buttons on both device and the wireless station again after the first 2 minutes.

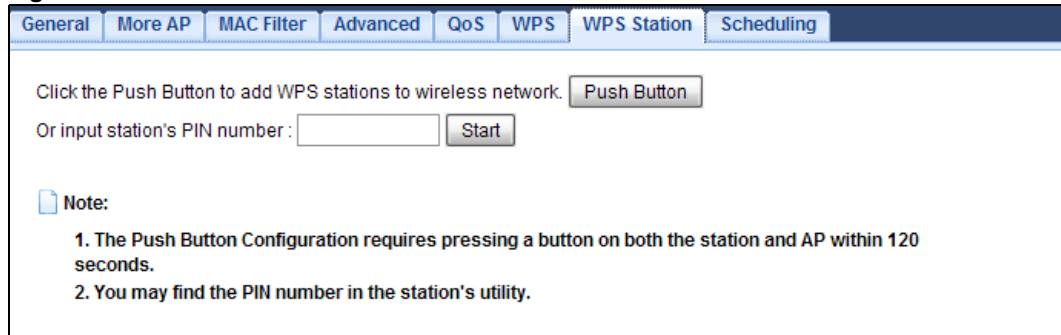
Figure 65 Network > Wireless LAN 2.4G/5G > WPS Station

The following table describes the labels in this screen.

Table 41 Network > Wireless LAN 2.4G/5G > WPS Station

LABEL	DESCRIPTION
Push Button	Use this button when you use the PBC (Push Button Configuration) method to configure wireless stations's wireless settings. Click this to start WPS-aware wireless station scanning and the wireless security information synchronization.
Or input station's PIN number	Use this button when you use the PIN Configuration method to configure wireless station's wireless settings. Type the same PIN number generated in the wireless station's utility. Then click Start to associate to each other and perform the wireless security information synchronization.

11.10 Scheduling Screen

Use this screen to set the times your wireless LAN is turned on and off. Wireless LAN scheduling is disabled by default. The wireless LAN can be scheduled to turn on or off on certain days and at certain times. To open this screen, click **Network > Wireless LAN 2.4G/5G > Scheduling** tab.

Figure 66 Network > Wireless LAN 2.4G/5G > Scheduling

Wireless LAN Scheduling : Enable Disable

Scheduling		
WLAN status	Day	For the following times (24-Hour Format)
<input type="radio"/> On <input checked="" type="radio"/> Off	<input type="checkbox"/> Everyday	00 (hour) 00 (min) ~ 00 (hour) 00 (min)
<input checked="" type="radio"/> On <input type="radio"/> Off	<input checked="" type="checkbox"/> Mon	00 (hour) 00 (min) ~ 00 (hour) 00 (min)
<input checked="" type="radio"/> On <input type="radio"/> Off	<input checked="" type="checkbox"/> Tue	00 (hour) 00 (min) ~ 00 (hour) 00 (min)
<input checked="" type="radio"/> On <input type="radio"/> Off	<input checked="" type="checkbox"/> Wed	00 (hour) 00 (min) ~ 00 (hour) 00 (min)
<input checked="" type="radio"/> On <input type="radio"/> Off	<input checked="" type="checkbox"/> Thu	00 (hour) 00 (min) ~ 00 (hour) 00 (min)
<input checked="" type="radio"/> On <input type="radio"/> Off	<input checked="" type="checkbox"/> Fri	00 (hour) 00 (min) ~ 00 (hour) 00 (min)
<input checked="" type="radio"/> On <input type="radio"/> Off	<input checked="" type="checkbox"/> Sat	00 (hour) 00 (min) ~ 00 (hour) 00 (min)
<input type="radio"/> On <input checked="" type="radio"/> Off	<input type="checkbox"/> Sun	00 (hour) 00 (min) ~ 00 (hour) 00 (min)

Note:
Specify the same begin time and end time means the whole day schedule.

Apply Cancel

The following table describes the labels in this screen.

Table 42 Network > Wireless LAN 2.4G/5G > Scheduling

LABEL	DESCRIPTION
Wireless LAN Scheduling	
Wireless LAN Scheduling	Select Enable to activate the wireless LAN scheduling feature. Select Disable to turn it off.
Scheduling	
WLAN Status	Select On or Off to specify whether the Wireless LAN is turned on or off. This field works in conjunction with the Day and For the following times fields.
Day	Select Everyday or the specific days to turn the Wireless LAN on or off. If you select Everyday you can not select any specific days. This field works in conjunction with the For the following times field.
For the following times (24-Hour Format)	Select a begin time using the first set of hour and minute (min) drop down boxes and select an end time using the second set of hour and minute (min) drop down boxes. If you have chosen On earlier for the WLAN Status the Wireless LAN will turn on between the two times you enter in these fields. If you have chosen Off earlier for the WLAN Status the Wireless LAN will turn off between the two times you enter in these fields.
Apply	Click Apply to save your changes back to the NBG6616.
Cancel	Click Cancel to reload the previous configuration for this screen.

12.1 Overview

This chapter describes how to configure LAN settings.

A Local Area Network (LAN) is a shared communication system to which many computers are attached. A LAN is a computer network limited to the immediate area, usually the same building or floor of a building.

Figure 67 LAN Example

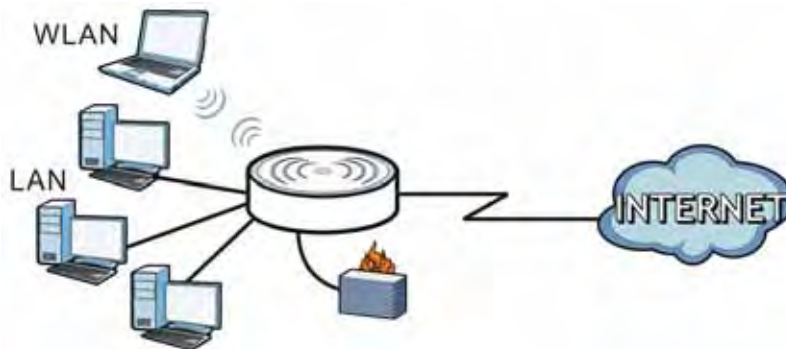

The LAN screens can help you configure a manage IP address, and partition your physical network into logical networks.

12.2 What You Can Do

- Use the **IP** screen to change the IP address for your NBG6616 ([Section 12.4 on page 108](#)).
- Use the **IP Alias** screen to have the NBG6616 apply IP alias to create LAN subnets ([Section 12.5 on page 109](#)).
- Use the **IPv6 LAN** screen to configure the IPv6 address for your NBG6616 on the LAN ([Section 12.6 on page 110](#)).

12.3 What You Need To Know

The actual physical connection determines whether the NBG6616 ports are LAN or WAN ports. There are two separate IP networks, one inside the LAN network and the other outside the WAN network as shown next.

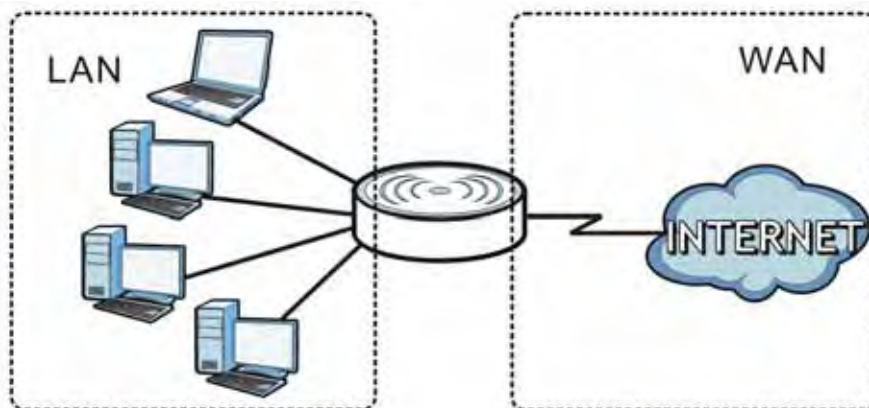
Figure 68 LAN and WAN IP Addresses

The LAN parameters of the NBG6616 are preset in the factory with the following values:

- IP address of 192.168.1.1 with subnet mask of 255.255.255.0 (24 bits)
- DHCP server enabled with 32 client IP addresses starting from 192.168.1.33.

These parameters should work for the majority of installations. If your ISP gives you explicit DNS server address(es), read the embedded Web Configurator help regarding what fields need to be configured.

12.3.1 IP Pool Setup

The NBG6616 is pre-configured with a pool of 32 IP addresses starting from 192.168.1.33 to 192.168.1.64. This configuration leaves 31 IP addresses (excluding the NBG6616 itself) in the lower range (192.168.1.2 to 192.168.1.32) for other server computers, for instance, servers for mail, FTP, TFTP, web, etc., that you may have.

12.3.2 LAN TCP/IP

The NBG6616 has built-in DHCP server capability that assigns IP addresses and DNS servers to systems that support DHCP client capability.

12.3.3 IP Alias

IP alias allows you to partition a physical network into different logical networks over the same Ethernet interface. The NBG6616 supports three logical LAN interfaces via its single physical Ethernet interface with the NBG6616 itself as the gateway for each LAN network.

12.4 LAN IP Screen

Use this screen to change the IP address for your NBG6616. Click **Network > LAN > IP**.

Figure 69 Network > LAN > IP

The following table describes the labels in this screen.

Table 43 Network > LAN > IP

LABEL	DESCRIPTION
IP Address	Type the IP address of your NBG6616 in dotted decimal notation.
IP Subnet Mask	The subnet mask specifies the network number portion of an IP address. Your NBG6616 will automatically calculate the subnet mask based on the IP address that you assign. Unless you are implementing subnetting, use the subnet mask computed by the NBG6616.
Apply	Click Apply to save your changes back to the NBG6616.
Cancel	Click Cancel to begin configuring this screen afresh.

12.5 IP Alias Screen

Use this screen to have the NBG6616 apply IP alias to create LAN subnets. Click **LAN > IP Alias**.

Figure 70 Network > LAN > IP Alias

The following table describes the labels in this screen.

Table 44 Network > LAN > IP Alias

LABEL	DESCRIPTION
IP Alias 1, 2	Check this to enable IP alias to configure another LAN network for the NBG6616.
IP Address	Type the IP alias address of your NBG6616 in dotted decimal notation.

Table 44 Network > LAN > IP Alias (continued)

LABEL	DESCRIPTION
IP Subnet Mask	The subnet mask specifies the network number portion of an IP address. Your NBG6616 will automatically calculate the subnet mask based on the IP address that you assign. Unless you are implementing subnetting, use the subnet mask computed by the NBG6616.
Apply	Click Apply to save your changes back to the NBG6616.
Cancel	Click Cancel to begin configuring this screen afresh.

12.6 IPv6 LAN Screen

Use this screen to configure the IPv6 address for your NBG6616 on the LAN. Click **Network > LAN > IPv6 LAN**.

Figure 71 Network > LAN > IPv6 LAN

The following table describes the labels on this screen.

Table 45 Network > LAN > IPv6 LAN

LABEL	DESCRIPTION
Enable DHCPv6-PD	Select this option to use DHCPv6 prefix delegation. The NBG6616 will obtain an IPv6 prefix from the ISP or a connected uplink router for the LAN.
Static IP Address	Select this option to manually enter an IPv6 address if you want to use a static IP address.
LAN IPv6 Address	Enter the IPv6 address for the NBG6616 on the LAN.
Apply	Click Apply to save your changes with the NBG6616.
Cancel	Click Cancel to begin configuring this screen afresh.

DHCP Server

13.1 Overview

DHCP (Dynamic Host Configuration Protocol, RFC 2131 and RFC 2132) allows individual clients to obtain TCP/IP configuration at start-up from a server. You can configure the NBG6616's LAN as a DHCP server or disable it. When configured as a server, the NBG6616 provides the TCP/IP configuration for the clients. If DHCP service is disabled, you must have another DHCP server on your LAN, or else the computer must be manually configured.

13.1.1 What You Can Do

- Use the **General** screen to enable the DHCP server ([Section 13.2 on page 111](#)).
- Use the **Advanced** screen to assign IP addresses on the LAN to specific individual computers based on their MAC Addresses ([Section 13.3 on page 112](#)).
- Use the **Client List** screen to view the current DHCP client information ([Section 13.4 on page 114](#)).

13.1.2 What You Need To Know

The following terms and concepts may help as you read through this chapter.

MAC Addresses

Every Ethernet device has a unique MAC (Media Access Control) address. The MAC address is assigned at the factory and consists of six pairs of hexadecimal characters, for example, 00:A0:C5:00:00:02. Find out the MAC addresses of your network devices if you intend to add them to the **DHCP Client List** screen.

13.2 DHCP Server General Screen

Use this screen to enable the DHCP server. Click **Network > DHCP Server**. The following screen displays.

Figure 72 Network > DHCP Server > General

The screenshot shows a configuration window with three tabs: 'General', 'Advanced', and 'Client List'. The 'General' tab is active. It contains the following fields:

- DHCP Server:** A radio button group with 'Enable' selected and 'Disable' unselected.
- IP Pool Starting Address:** A text input field containing '192.168.1.33'.
- Pool Size:** A text input field containing '32'.

At the bottom of the window are two buttons: 'Apply' and 'Cancel'.

The following table describes the labels in this screen.

Table 46 Network > DHCP Server > General

LABEL	DESCRIPTION
DHCP Server	Select Enable to activate DHCP for LAN. DHCP (Dynamic Host Configuration Protocol, RFC 2131 and RFC 2132) allows individual clients (computers) to obtain TCP/IP configuration at startup from a server. Enable the DHCP server unless your ISP instructs you to do otherwise. Select Disable to stop the NBG6616 acting as a DHCP server. When configured as a server, the NBG6616 provides TCP/IP configuration for the clients. If not, DHCP service is disabled and you must have another DHCP server on your LAN, or else the computers must be manually configured. When set as a server, fill in the following four fields.
IP Pool Starting Address	This field specifies the first of the contiguous addresses in the IP address pool for LAN.
Pool Size	This field specifies the size, or count of the IP address pool for LAN.
Apply	Click Apply to save your changes back to the NBG6616.
Cancel	Click Cancel to begin configuring this screen afresh.

13.3 DHCP Server Advanced Screen

This screen allows you to assign IP addresses on the LAN to specific individual computers based on their MAC addresses. You can also use this screen to configure the DNS server information that the NBG6616 sends to the DHCP clients.

To change your NBG6616's static DHCP settings, click **Network > DHCP Server > Advanced**. The following screen displays.

Figure 73 Network > DHCP Server > Advanced

#	MAC Address	IP Address
1	00:00:00:00:00:00	0.0.0.0
2	00:00:00:00:00:00	0.0.0.0
3	00:00:00:00:00:00	0.0.0.0
4	00:00:00:00:00:00	0.0.0.0
5	00:00:00:00:00:00	0.0.0.0
6	00:00:00:00:00:00	0.0.0.0
7	00:00:00:00:00:00	0.0.0.0
8	00:00:00:00:00:00	0.0.0.0

DNS Server
DNS Servers Assigned by DHCP Server

First DNS Server :

Second DNS Server :

Third DNS Server :

The following table describes the labels in this screen.

Table 47 Network > DHCP Server > Advanced

LABEL	DESCRIPTION
Static DHCP Table	
#	This is the index number of the static IP table entry (row).
MAC Address	Type the MAC address (with colons) of a computer on your LAN.
IP Address	Type the LAN IP address of a computer on your LAN.
DNS Server	
DNS Servers Assigned by DHCP Server	The NBG6616 passes a DNS (Domain Name System) server IP address (in the order you specify here) to the DHCP clients. The NBG6616 only passes this information to the LAN DHCP clients when you enable DHCP Server . When you disable DHCP Server , DHCP service is disabled and you must have another DHCP sever on your LAN, or else the computers must have their DNS server addresses manually configured.

Table 47 Network > DHCP Server > Advanced (continued)

LABEL	DESCRIPTION
First DNS Server	Select Obtained From ISP if your ISP dynamically assigns DNS server information (and the NBG6616's WAN IP address). The field to the right displays the (read-only) DNS server IP address that the ISP assigns.
Second DNS Server	
Third DNS Server	
	Select User-Defined if you have the IP address of a DNS server. Enter the DNS server's IP address in the field to the right.
	Select DNS Relay to have the NBG6616 act as a DNS proxy. The NBG6616's LAN IP address displays in the field to the right (read-only). The NBG6616 tells the DHCP clients on the LAN that the NBG6616 itself is the DNS server. When a computer on the LAN sends a DNS query to the NBG6616, the NBG6616 forwards the query to the NBG6616's system DNS server (configured in the WAN screen) and relays the response back to the computer. You can only select DNS Relay for one of the three servers; if you select DNS Relay for a second or third DNS server, that choice changes to None after you click Apply .
	Select None if you do not want to configure DNS servers. If you do not configure a DNS server, you must know the IP address of a computer in order to access it.
Apply	Click Apply to save your changes back to the NBG6616.
Cancel	Click Cancel to begin configuring this screen afresh.

13.4 DHCP Client List Screen

The DHCP table shows current DHCP client information (including IP Address, Host Name and MAC Address) of network clients using the NBG6616's DHCP servers.

Configure this screen to always assign an IP address to a MAC address (and host name). Click **Network > DHCP Server > Client List**.

Note: You can also view a read-only client list by clicking **Monitor > DHCP Server**.

Figure 74 Network > DHCP Server > Client List

#	Status	Host Name	IP Address	MAC Address	Reserve
1		twpc	192.168.1.46	00:21:85:0c:44:4b	<input type="checkbox"/>

The following table describes the labels in this screen.

Table 48 Network > DHCP Server > Client List

LABEL	DESCRIPTION
#	This is the index number of the host computer.
Status	This field displays whether the connection to the host computer is up (a yellow bulb) or down (a gray bulb).
Host Name	This field displays the computer host name.
IP Address	This field displays the IP address relative to the # field listed above.

Table 48 Network > DHCP Server > Client List (continued)

LABEL	DESCRIPTION
MAC Address	This field shows the MAC address of the computer with the name in the Host Name field. Every Ethernet device has a unique MAC (Media Access Control) address which uniquely identifies a device. The MAC address is assigned at the factory and consists of six pairs of hexadecimal characters, for example, 00:A0:C5:00:00:02.
Reserve	Select this if you want to reserve the IP address for this specific MAC address.
Apply	Click Apply to save your changes back to the NBG6616.
Cancel	Click Cancel to reload the previous configuration for this screen.

14.1 Overview

NAT (Network Address Translation - NAT, RFC 1631) is the translation of the IP address of a host in a packet. For example, the source address of an outgoing packet, used within one network is changed to a different IP address known within another network.

The figure below is a simple illustration of a NAT network. You want to assign ports 21-25 to one FTP, Telnet and SMTP server (**A** in the example), port 80 to another (**B** in the example) and assign a default server IP address of 192.168.1.35 to a third (**C** in the example).

You assign the LAN IP addresses to the devices (**A** to **D**) connected to your NBG6616. The ISP assigns the WAN IP address. The NAT network appears as a single host on the Internet. All traffic coming from **A** to **D** going out to the Internet use the IP address of the NBG6616, which is 192.168.1.1.

Figure 75 NAT Example

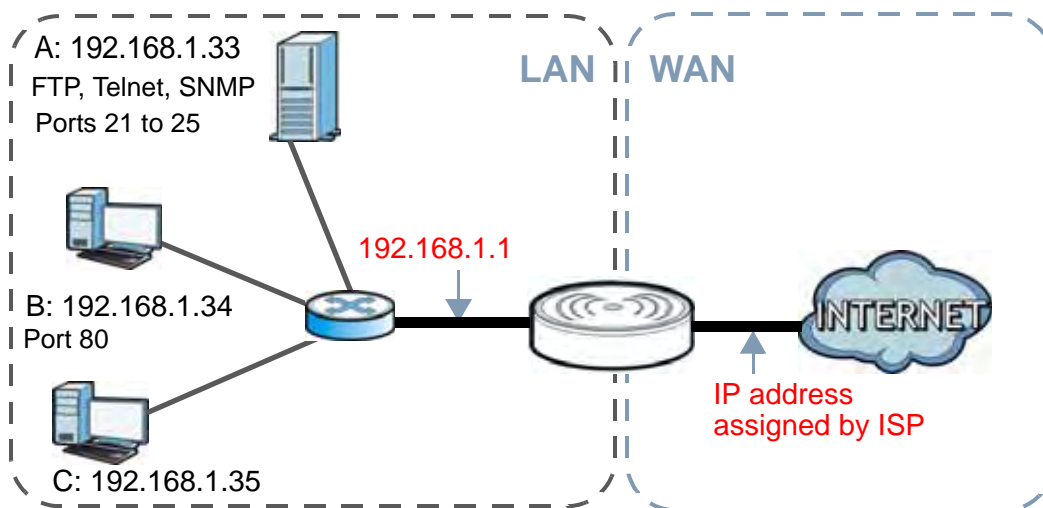

This chapter discusses how to configure NAT on the NBG6616.

Note: You must create a firewall rule in addition to setting up NAT, to allow traffic from the WAN to be forwarded through the NBG6616.

14.1.1 What You Can Do

- Use the **General** screen to enable NAT ([Section 14.2 on page 118](#)).

- Use the **Port Forwarding** screen to set a default server and change your NBG6616's port forwarding settings to forward incoming service requests to the server(s) on your local network ([Section 14.3 on page 119](#)).
- Use the **Port Trigger** screen to change your NBG6616's trigger port settings ([Section 14.5.3 on page 124](#)).

14.1.2 What You Need To Know

The following terms and concepts may help as you read through this chapter.

Inside/Outside

This denotes where a host is located relative to the NBG6616, for example, the computers of your subscribers are the inside hosts, while the web servers on the Internet are the outside hosts.

Global/Local

This denotes the IP address of a host in a packet as the packet traverses a router, for example, the local address refers to the IP address of a host when the packet is in the local network, while the global address refers to the IP address of the host when the same packet is traveling in the WAN side.

Note: Inside/outside refers to the location of a host, while global/local refers to the IP address of a host used in a packet.

An inside local address (ILA) is the IP address of an inside host in a packet when the packet is still in the local network, while an inside global address (IGA) is the IP address of the same inside host when the packet is on the WAN side. The following table summarizes this information.

Table 49 NAT Definitions

ITEM	DESCRIPTION
Inside	This refers to the host on the LAN.
Outside	This refers to the host on the WAN.
Local	This refers to the packet address (source or destination) as the packet travels on the LAN.
Global	This refers to the packet address (source or destination) as the packet travels on the WAN.

Note: NAT never changes the IP address (either local or global) of an outside host.

What NAT Does

In the simplest form, NAT changes the source IP address in a packet received from a subscriber (the inside local address) to another (the inside global address) before forwarding the packet to the WAN side. When the response comes back, NAT translates the destination address (the inside global address) back to the inside local address before forwarding it to the original inside host. Note that the IP address (either local or global) of an outside host is never changed.

The global IP addresses for the inside hosts can be either static or dynamically assigned by the ISP. In addition, you can designate servers, for example, a web server and a telnet server, on your local

network and make them accessible to the outside world. If you do not define any servers, NAT offers the additional benefit of firewall protection. With no servers defined, your NBG6616 filters out all incoming inquiries, thus preventing intruders from probing your network. For more information on IP address translation, refer to *RFC 1631, The IP Network Address Translator (NAT)*.

How NAT Works

Each packet has two addresses – a source address and a destination address. For outgoing packets, the ILA (Inside Local Address) is the source address on the LAN, and the IGA (Inside Global Address) is the source address on the WAN. For incoming packets, the ILA is the destination address on the LAN, and the IGA is the destination address on the WAN. NAT maps private (local) IP addresses to globally unique ones required for communication with hosts on other networks. It replaces the original IP source address in each packet and then forwards it to the Internet. The NBG6616 keeps track of the original addresses and port numbers so incoming reply packets can have their original values restored. The following figure illustrates this.

Figure 76 How NAT Works

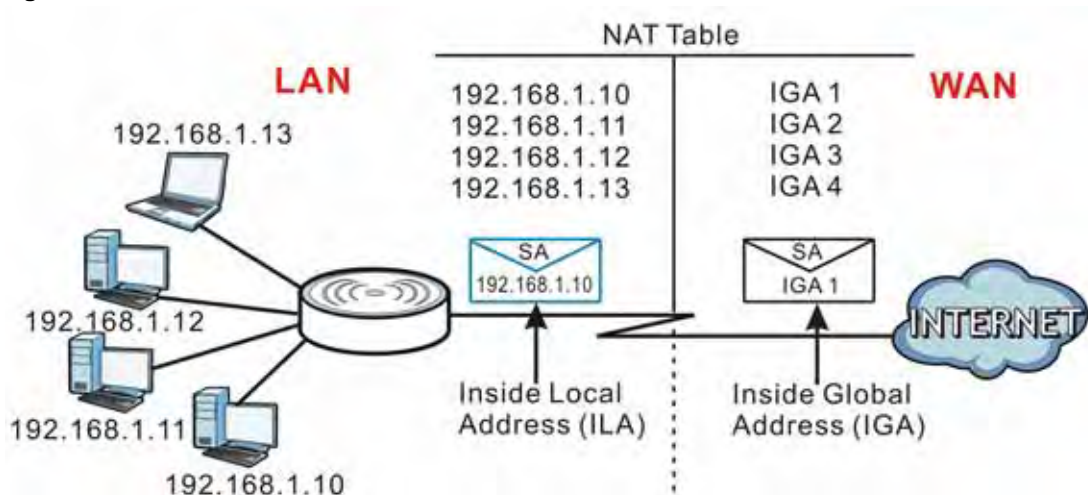

14.2 General

Use this screen to enable NAT and set a default server. Click **Network > NAT** to open the **General** screen.

Figure 77 Network > NAT > General

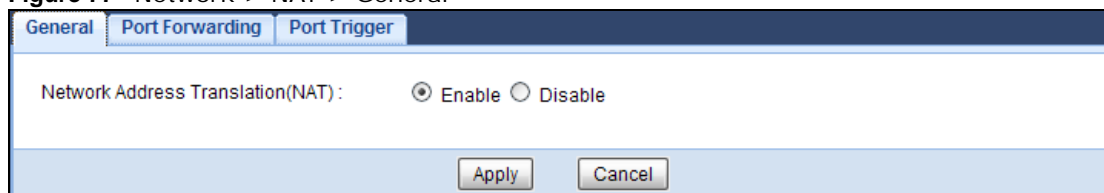

The following table describes the labels in this screen.

Table 50 Network > NAT > General

LABEL	DESCRIPTION
Network Address Translation (NAT)	Network Address Translation (NAT) allows the translation of an Internet protocol address used within one network (for example a private IP address used in a local network) to a different IP address known within another network (for example a public IP address used on the Internet). Select Enable to activate NAT. Select Disable to turn it off.
Apply	Click Apply to save your changes back to the NBG6616.
Cancel	Click Cancel to begin configuring this screen afresh.

14.3 Port Forwarding Screen

Use this screen to forward incoming service requests to the server(s) on your local network and set a default server. You may enter a single port number or a range of port numbers to be forwarded, and the local IP address of the desired server. The port number identifies a service; for example, web service is on port 80 and FTP on port 21. In some cases, such as for unknown services or where one server can support more than one service (for example both FTP and web service), it might be better to specify a range of port numbers.

In addition to the servers for specified services, NAT supports a default server. A service request that does not have a server explicitly designated for it is forwarded to the default server. If the default is not defined, the service request is simply discarded.

Note: Many residential broadband ISP accounts do not allow you to run any server processes (such as a Web or FTP server) from your location. Your ISP may periodically check for servers and may suspend your account if it discovers any active services at your location. If you are unsure, refer to your ISP.

Port forwarding allows you to define the local servers to which the incoming services will be forwarded. To change your NBG6616's port forwarding settings, click **Network > NAT > Port Forwarding**. The screen appears as shown.

Note: If you do not assign a **Default Server**, the NBG6616 discards all packets received for ports that are not specified in this screen or remote management.

Refer to [Appendix C on page 228](#) for port numbers commonly used for particular services.

Figure 78 Network > NAT > Port Forwarding

Default Server Setup

Default Server 192.168.1.1
 Change To Server

Service Name: WWW
 Service Protocol
 Server IP Address
 Port (Ex: 10-20,30,40)

#	Status	Name	Protocol	Port	Server IP Address	Modify
1		SIP	TCP_UDP	5060	192.168.1.99	

The following table describes the labels in this screen.

Table 51 Network > NAT > Port Forwarding

LABEL	DESCRIPTION
Default Server Setup	
Default Server	In addition to the servers for specified services, NAT supports a default server. A default server receives packets from ports that are not specified in the Port Forwarding screen. You can decide whether you want to use the default server or specify a server manually. Select this to use the default server.
Change to Server	Select this and manually enter the server's IP address.
Service Name	Select a pre-defined service from the drop-down list box. The pre-defined service port number(s) and protocol will be displayed in the port forwarding summary table. Otherwise, select User define to manually enter the port number(s) and select the IP protocol.
Service Protocol	Select the transport layer protocol supported by this virtual server. Choices are TCP , UDP , or TCP_UDP . If you have chosen a pre-defined service in the Service Name field, the protocol will be configured automatically.
Server IP Address	Enter the inside IP address of the virtual server here and click Add to add it in the port forwarding summary table.
#	This is the number of an individual port forwarding server entry.
Status	This icon is turned on when the rule is enabled.
Name	This field displays a name to identify this rule.
Protocol	This is the transport layer protocol used for the service.
Port	This field displays the port number(s).
Server IP Address	This field displays the inside IP address of the server.
Modify	Click the Edit icon to open the edit screen where you can modify an existing rule. Click the Delete icon to remove a rule.

Table 51 Network > NAT > Port Forwarding (continued)

LABEL	DESCRIPTION
Apply	Click Apply to save your changes back to the NBG6616.
Cancel	Click Cancel to begin configuring this screen afresh.

14.3.1 Port Forwarding Edit Screen

This screen lets you edit a port forwarding rule. Click a rule's **Edit** icon in the **Port Forwarding** screen to open the following screen.

Figure 79 Network > NAT > Port Forwarding Edit

Port Forwarding : Enable Disable

Service Name : VoIP (SIP) ▼

Protocol : ▼

Port : (Ex: 10-20,30,40)

Server IP Address :

The following table describes the labels in this screen.

Table 52 Network > NAT > Port Forwarding Edit

LABEL	DESCRIPTION
Port Forwarding	Select Enable to turn on this rule and the requested service can be forwarded to the host with a specified internal IP address. Select Disable to disallow forwarding of these ports to an inside server without having to delete the entry.
Service Name	Select User define and type a name (of up to 31 printable characters) to identify this rule in the first field next to Service Name . Otherwise, select a predefined service in the second field next to Service Name . The predefined service name and port number(s) will display in the Service Name and Port fields.
Protocol	Select the transport layer protocol supported by this virtual server. Choices are TCP , UDP , or TCP_UDP . If you have chosen a pre-defined service in the Service Name field, the protocol will be configured automatically.
Port	Type a port number(s) to define the service to be forwarded to the specified server. To specify a range of ports, enter a hyphen (-) between the first port and the last port, such as 10-.
Server IP Address	Type the IP address of the server on your LAN that receives packets from the port(s) specified in the Port field.
Back	Click Back to return to the previous screen.
Apply	Click Apply to save your changes back to the NBG6616.
Cancel	Click Cancel to begin configuring this screen afresh.

14.4 Port Trigger Screen

To change your NBG6616's trigger port settings, click **Network > NAT > Port Trigger**. The screen appears as shown.

Note: Only one LAN computer can use a trigger port (range) at a time.

Figure 80 Network > NAT > Port Trigger

#	Name	incoming		trigger	
		Port	End Port	Port	End Port
1		0	0	0	0
2		0	0	0	0
3		0	0	0	0
4		0	0	0	0
5		0	0	0	0
6		0	0	0	0
7		0	0	0	0
8		0	0	0	0
9		0	0	0	0
10		0	0	0	0
11		0	0	0	0
12		0	0	0	0

The following table describes the labels in this screen.

Table 53 Network > NAT > Port Trigger

LABEL	DESCRIPTION
#	This is the rule index number (read-only).
Name	Type a unique name (up to 15 characters) for identification purposes. All characters are permitted - including spaces.
Incoming	Incoming is a port (or a range of ports) that a server on the WAN uses when it sends out a particular service. The NBG6616 forwards the traffic with this port (or range of ports) to the client computer on the LAN that requested the service.
Port	Type a port number or the starting port number in a range of port numbers.
End Port	Type a port number or the ending port number in a range of port numbers.
Trigger	The trigger port is a port (or a range of ports) that causes (or triggers) the NBG6616 to record the IP address of the LAN computer that sent the traffic to a server on the WAN.
Port	Type a port number or the starting port number in a range of port numbers.
End Port	Type a port number or the ending port number in a range of port numbers.
Apply	Click Apply to save your changes back to the NBG6616.
Cancel	Click Cancel to begin configuring this screen afresh.

14.5 Technical Reference

The following section contains additional technical information about the NBG6616 features described in this chapter.

14.5.1 NATPort Forwarding: Services and Port Numbers

A port forwarding set is a list of inside (behind NAT on the LAN) servers, for example, web or FTP, that you can make accessible to the outside world even though NAT makes your whole inside network appear as a single machine to the outside world.

Use the **Port Forwarding** screen to forward incoming service requests to the server(s) on your local network. You may enter a single port number or a range of port numbers to be forwarded, and the local IP address of the desired server. The port number identifies a service; for example, web service is on port 80 and FTP on port 21. In some cases, such as for unknown services or where one server can support more than one service (for example both FTP and web service), it might be better to specify a range of port numbers.

In addition to the servers for specified services, NAT supports a default server. A service request that does not have a server explicitly designated for it is forwarded to the default server. If the default is not defined, the service request is simply discarded.

Note: Many residential broadband ISP accounts do not allow you to run any server processes (such as a Web or FTP server) from your location. Your ISP may periodically check for servers and may suspend your account if it discovers any active services at your location. If you are unsure, refer to your ISP.

14.5.2 NAT Port Forwarding Example

Let's say you want to assign ports 21-25 to one FTP, Telnet and SMTP server (**A** in the example), port 80 to another (**B** in the example) and assign a default server IP address of 192.168.1.35 to a third (**C** in the example). You assign the LAN IP addresses and the ISP assigns the WAN IP address. The NAT network appears as a single host on the Internet.

Figure 81 Multiple Servers Behind NAT Example

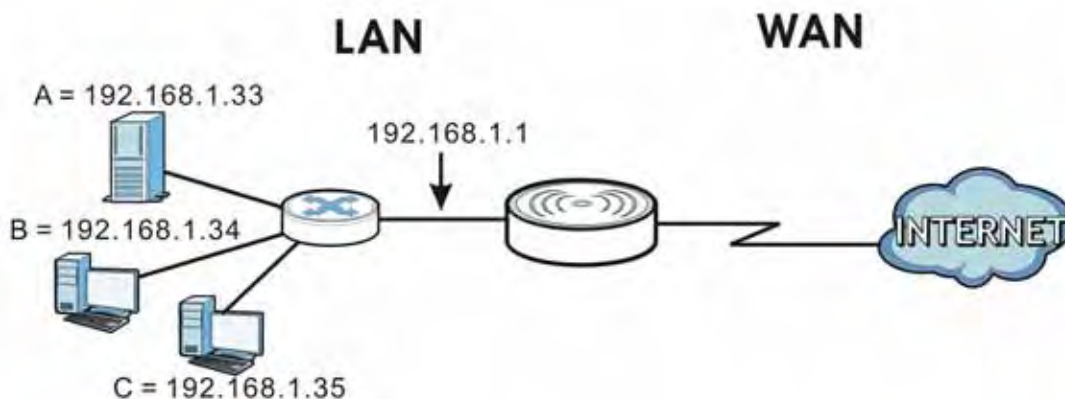

14.5.3 Trigger Port Forwarding

Some services use a dedicated range of ports on the client side and a dedicated range of ports on the server side. With regular port forwarding you set a forwarding port in NAT to forward a service (coming in from the server on the WAN) to the IP address of a computer on the client side (LAN). The problem is that port forwarding only forwards a service to a single LAN IP address. In order to use the same service on a different LAN computer, you have to manually replace the LAN computer's IP address in the forwarding port with another LAN computer's IP address.

Trigger port forwarding solves this problem by allowing computers on the LAN to dynamically take turns using the service. The NBG6616 records the IP address of a LAN computer that sends traffic to the WAN to request a service with a specific port number and protocol (a "trigger" port). When the NBG6616's WAN port receives a response with a specific port number and protocol ("incoming" port), the NBG6616 forwards the traffic to the LAN IP address of the computer that sent the request. After that computer's connection for that service closes, another computer on the LAN can use the service in the same manner. This way you do not need to configure a new IP address each time you want a different LAN computer to use the application.

14.5.4 Trigger Port Forwarding Example

The following is an example of trigger port forwarding.

Figure 82 Trigger Port Forwarding Process: Example

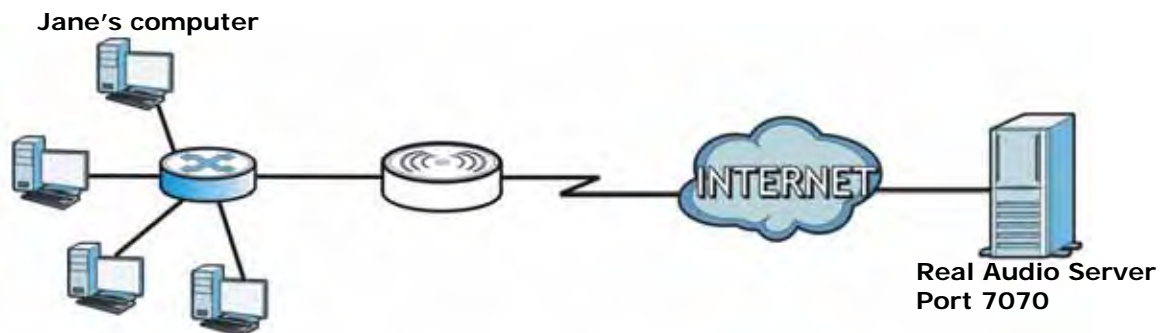

- 1 Jane requests a file from the Real Audio server (port 7070).
- 2 Port 7070 is a "trigger" port and causes the NBG6616 to record Jane's computer IP address. The NBG6616 associates Jane's computer IP address with the "incoming" port range of 6970-7170.
- 3 The Real Audio server responds using a port number ranging between 6970-7170.
- 4 The NBG6616 forwards the traffic to Jane's computer IP address.
- 5 Only Jane can connect to the Real Audio server until the connection is closed or times out. The NBG6616 times out in three minutes with UDP (User Datagram Protocol), or two hours with TCP/IP (Transfer Control Protocol/Internet Protocol).

14.5.5 Two Points To Remember About Trigger Ports

- 1 Trigger events only happen on data that is coming from inside the NBG6616 and going to the outside.
- 2 If an application needs a continuous data stream, that port (range) will be tied up so that another computer on the LAN can't trigger it.

15.1 Overview

DDNS services let you use a domain name with a dynamic IP address.

15.1.1 What You Need To Know

The following terms and concepts may help as you read through this chapter.

What is DDNS?

Dynamic Domain Name Service (DDNS) services let you use a fixed domain name with a dynamic IP address. Users can always use the same domain name instead of a different dynamic IP address that changes each time to connect to the NBG6616 or a server in your network.

Note: The NBG6616 must have a public global IP address and you should have your registered DDNS account information on hand.

15.2 General

To change your NBG6616's DDNS, click **Network > DDNS**. The screen appears as shown.

Figure 83 Dynamic DNS

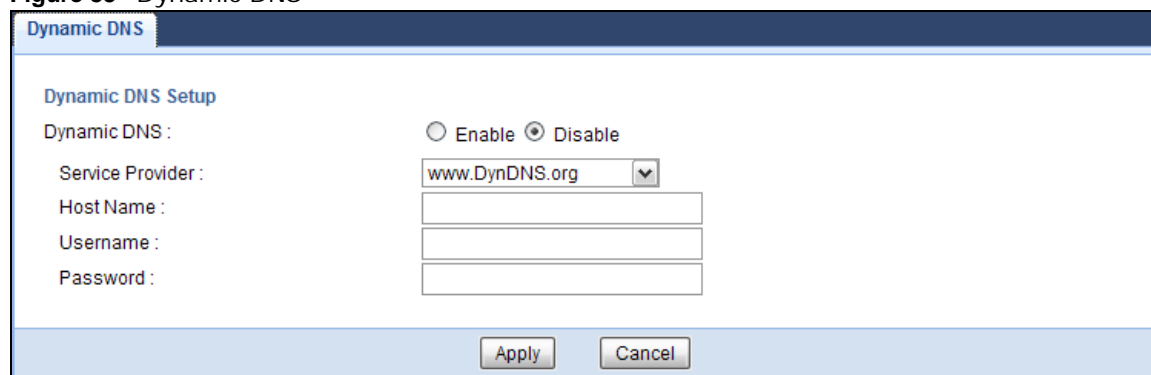

The screenshot shows a web-based configuration window titled "Dynamic DNS". The window has a blue header bar with the title "Dynamic DNS". Below the header, the main content area is titled "Dynamic DNS Setup". Under this title, there is a "Dynamic DNS:" label followed by two radio buttons: "Enable" (which is unselected) and "Disable" (which is selected). Below the radio buttons, there are four input fields: "Service Provider:" with a dropdown menu showing "www.DynDNS.org", "Host Name:", "Username:", and "Password:". At the bottom of the window, there are two buttons: "Apply" and "Cancel".

The following table describes the labels in this screen.

Table 54 Dynamic DNS

LABEL	DESCRIPTION
Dynamic DNS	Select Enable to use dynamic DNS. Select Disable to turn this feature off.
Service Provider	Select the name of your Dynamic DNS service provider.
Host Name	Enter a host names in the field provided. You can specify up to two host names in the field separated by a comma (",").
Username	Enter your user name.
Password	Enter the password assigned to you.
Apply	Click Apply to save your changes back to the NBG6616.
Cancel	Click Cancel to begin configuring this screen afresh.

Static Route

16.1 Overview

This chapter shows you how to configure static routes for your NBG6616.

The NBG6616 usually uses the default gateway to route outbound traffic from computers on the LAN to the Internet. To have the NBG6616 send data to devices not reachable through the default gateway, use static routes.

For example, the next figure shows a computer (**A**) connected to the NBG6616's LAN interface. The NBG6616 routes most traffic from **A** to the Internet through the NBG6616's default gateway (**R1**). You create one static route to connect to services offered by your ISP behind router **R2**. You create another static route to communicate with a separate network behind a router **R3** connected to the LAN.

Figure 84 Example of Static Routing Topology

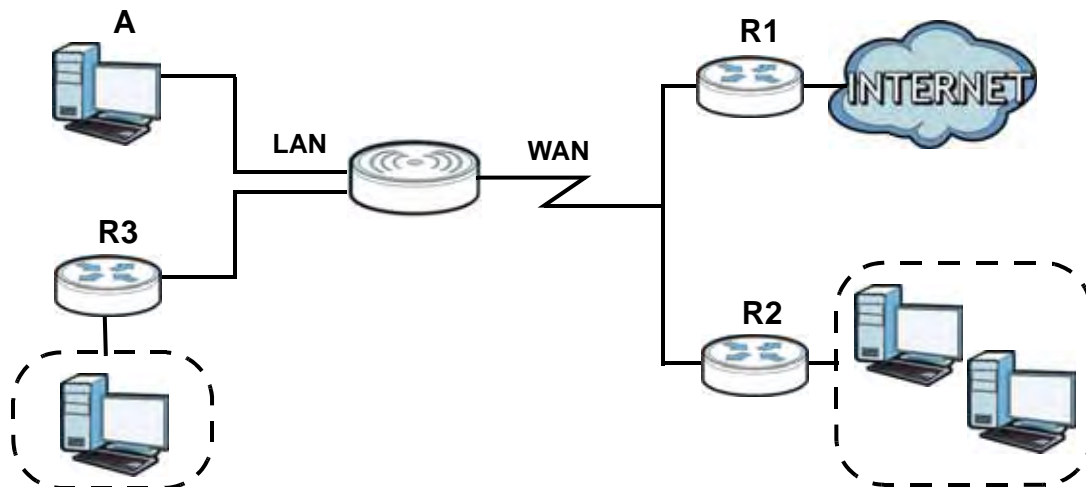

16.2 IP Static Route Screen

Click **Network > Static Route** to open the **Static Route** screen.

Figure 85 Network > Static Route

#	Status	Name	Destination	Gateway	Subnet Mask	Modify
1		example	10.1.2.3	10.1.2.86	255.255.255.0	

The following table describes the labels in this screen.

Table 55 Network > Static Route

LABEL	DESCRIPTION
Add Static Route	Click this to create a new rule.
#	This is the number of an individual static route.
Status	This field indicates whether the rule is active (yellow bulb) or not (gray bulb).
Name	This field displays a name to identify this rule.
Destination	This parameter specifies the IP network address of the final destination. Routing is always based on network number.
Gateway	This is the IP address of the gateway. The gateway is a router or switch on the same network segment as the device's LAN or WAN port. The gateway helps forward packets to their destinations.
Subnet Mask	This parameter specifies the IP network subnet mask of the final destination.
Modify	Click the Edit icon to open a screen where you can modify an existing rule. Click the Delete icon to remove a rule from the NBG6616.
Apply	Click Apply to save your changes back to the NBG6616.
Cancel	Click Cancel to begin configuring this screen afresh.

16.2.1 Add/Edit Static Route

Click the **Add Static Route** button or a rule's **Edit** icon in the **Static Route** screen. Use this screen to configure the required information for a static route.

Figure 86 Network > Static Route: Add/Edit

Static Route : Enable Disable

Route Name :

Destination IP Address :

IP Subnet Mask :

Gateway IP Address :

The following table describes the labels in this screen.

Table 56 Network > Static Route: Add/Edit

LABEL	DESCRIPTION
Static Route	Select to enable or disable this rule.
Route Name	Type a name to identify this rule. You can use up to 31 printable English keyboard characters, including spaces.
Destination IP Address	This parameter specifies the IP network address of the final destination. Routing is always based on network number. If you need to specify a route to a single host, use a subnet mask of 255.255.255.255 in the subnet mask field to force the network number to be identical to the host ID.
IP Subnet Mask	Enter the IP subnet mask here.
Gateway IP Address	Enter the IP address of the next-hop gateway. The gateway is a router or switch on the same segment as your NBG6616's interface(s). The gateway helps forward packets to their destinations.
Back	Click Back to return to the previous screen without saving.
Apply	Click Apply to save your changes back to the NBG6616.
Cancel	Click Cancel to set every field in this screen to its last-saved value.

17.1 Overview

Use these screens to enable and configure the firewall that protects your NBG6616 and your LAN from unwanted or malicious traffic.

Enable the firewall to protect your LAN computers from attacks by hackers on the Internet and control access between the LAN and WAN. By default the firewall:

- allows traffic that originates from your LAN computers to go to all of the networks.
- blocks traffic that originates on the other networks from going to the LAN.

The following figure illustrates the default firewall action. User **A** can initiate an IM (Instant Messaging) session from the LAN to the WAN (1). Return traffic for this session is also allowed (2). However other traffic initiated from the WAN is blocked (3 and 4).

Figure 87 Default Firewall Action

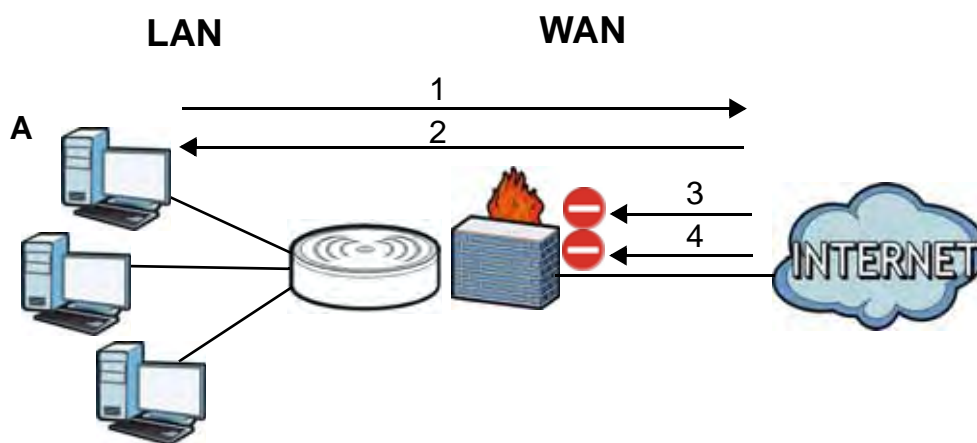

17.1.1 What You Can Do

- Use the **General** screen to enable or disable the NBG6616's firewall ([Section 17.2 on page 133](#)).
- Use the **Services** screen enable service blocking, enter/delete/modify the services you want to block and the date/time you want to block them ([Section 17.3 on page 133](#)).

17.1.2 What You Need To Know

The following terms and concepts may help as you read through this chapter.

What is a Firewall?

Originally, the term "firewall" referred to a construction technique designed to prevent the spread of fire from one room to another. The networking term "firewall" is a system or group of systems that enforces an access-control policy between two networks. It may also be defined as a mechanism used to protect a trusted network from a network that is not trusted. Of course, firewalls cannot solve every security problem. A firewall is one of the mechanisms used to establish a network security perimeter in support of a network security policy. It should never be the only mechanism or method employed. For a firewall to guard effectively, you must design and deploy it appropriately. This requires integrating the firewall into a broad information-security policy. In addition, specific policies must be implemented within the firewall itself.

Stateful Inspection Firewall

Stateful inspection firewalls restrict access by screening data packets against defined access rules. They make access control decisions based on IP address and protocol. They also "inspect" the session data to assure the integrity of the connection and to adapt to dynamic protocols. These firewalls generally provide the best speed and transparency; however, they may lack the granular application level access control or caching that some proxies support. Firewalls, of one type or another, have become an integral part of standard security solutions for enterprises.

About the NBG6616 Firewall

The NBG6616's firewall feature physically separates the LAN and the WAN and acts as a secure gateway for all data passing between the networks.

It is a stateful inspection firewall and is designed to protect against Denial of Service attacks when activated (click the **General** tab under **Firewall** and then click the **Enable Firewall** check box). The NBG6616's purpose is to allow a private Local Area Network (LAN) to be securely connected to the Internet. The NBG6616 can be used to prevent theft, destruction and modification of data, as well as log events, which may be important to the security of your network.

The NBG6616 is installed between the LAN and a broadband modem connecting to the Internet. This allows it to act as a secure gateway for all data passing between the Internet and the LAN.

The NBG6616 has one Ethernet WAN port and four Ethernet LAN ports, which are used to physically separate the network into two areas. The WAN (Wide Area Network) port attaches to the broadband (cable or DSL) modem to the Internet.

The LAN (Local Area Network) port attaches to a network of computers, which needs security from the outside world. These computers will have access to Internet services such as e-mail, FTP and the World Wide Web. However, "inbound access" is not allowed (by default) unless the remote host is authorized to use a specific service.

Guidelines For Enhancing Security With Your Firewall

- 1 Change the default password via Web Configurator.
- 2 Think about access control before you connect to the network in any way, including attaching a modem to the port.
- 3 Limit who can access your router.

- 4 Don't enable any local service (such as NTP) that you don't use. Any enabled service could present a potential security risk. A determined hacker might be able to find creative ways to misuse the enabled services to access the firewall or the network.
- 5 For local services that are enabled, protect against misuse. Protect by configuring the services to communicate only with specific peers, and protect by configuring rules to block packets for the services at specific interfaces.
- 6 Protect against IP spoofing by making sure the firewall is active.
- 7 Keep the firewall in a secured (locked) room.

17.2 General Screen

Use this screen to enable or disable the NBG6616's firewall, and set up firewall logs. Click **Security > Firewall** to open the **General** screen.

Figure 88 Security > Firewall > General I

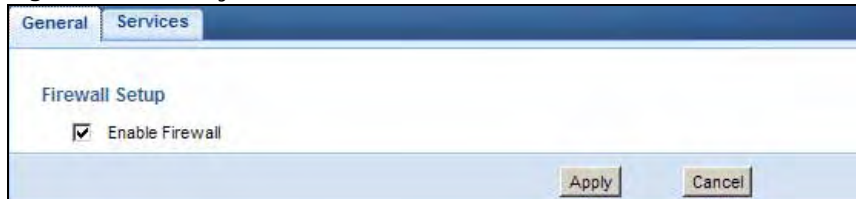

The following table describes the labels in this screen.

Table 57 Security > Firewall > General

LABEL	DESCRIPTION
Enable Firewall	Select this check box to activate the firewall. The NBG6616 performs access control and protects against Denial of Service (DoS) attacks when the firewall is activated.
Apply	Click Apply to save the settings.
Cancel	Click Cancel to start configuring this screen again.

17.3 Services Screen

If an outside user attempts to probe an unsupported port on your NBG6616, an ICMP response packet is automatically returned. This allows the outside user to know the NBG6616 exists. Use this screen to prevent the ICMP response packet from being sent. This keeps outsiders from discovering your NBG6616 when unsupported ports are probed.

You can also use this screen to enable service blocking, enter/delete/modify the services you want to block and the date/time you want to block them.

Click **Security > Firewall > Services**. The screen appears as shown next.

Figure 89 Security > Firewall > Services I

ICMP

Respond to Ping on:

Enable Firewall Rule

Enable Firewall Rule

Add Firewall Rule

Service Name :

MAC Address :

Dest IP Address :

Source IP Address :

Protocol :

DestPortRange : -

SourcePortRange : -

Firewall Rule

#	ServiceName	MACAddress	DestIP	SourceIP	Protocol	DestPortRange	SourcePortRange	Action	Delete
1	test	AA:BB:AA:BB:AA:BB	192.168.1.88	10.1.2.3	TCP	-	-	DROP	

The following table describes the labels in this screen.

Table 58 Security > Firewall > Services

LABEL	DESCRIPTION
ICMP	Internet Control Message Protocol is a message control and error-reporting protocol between a host server and a gateway to the Internet. ICMP uses Internet Protocol (IP) datagrams, but the messages are processed by the TCP/IP software and directly apparent to the application user.
Respond to Ping on	The NBG6616 will not respond to any incoming Ping requests when Disable is selected. Select LAN to reply to incoming LAN Ping requests. Select WAN to reply to incoming WAN Ping requests. Otherwise select LAN&WAN to reply to all incoming LAN and WAN Ping requests.
Apply	Click Apply to save the settings.
Enable Firewall Rule	
Enable Firewall Rule	Select this check box to activate the firewall rules that you define (see Add Firewall Rule below).
Apply	Click Apply to save the settings.
Add Firewall Rule	
Service Name	Enter a name that identifies or describes the firewall rule.
MAC Address	Enter the MAC address of the computer for which the firewall rule applies.
Dest IP Address	Enter the IP address of the computer to which traffic for the application or service is entering. The NBG6616 applies the firewall rule to traffic initiating from this computer.

Table 58 Security > Firewall > Services (continued)

LABEL	DESCRIPTION
Source IP Address	Enter the IP address of the computer that initializes traffic for the application or service. The NBG6616 applies the firewall rule to traffic initiating from this computer.
Protocol	Select the protocol (TCP , UDP or ICMP) used to transport the packets for which you want to apply the firewall rule.
Dest Port Range	Enter the port number/range of the destination that define the traffic type, for example TCP port 80 defines web traffic.
Source Port Range	Enter the port number/range of the source that define the traffic type, for example TCP port 80 defines web traffic.
Add Rule	Click Add to save the firewall rule.
Firewall Rule	
#	This is your firewall rule number. The ordering of your rules is important as rules are applied in turn.
Service Name	This is a name that identifies or describes the firewall rule.
MAC address	This is the MAC address of the computer for which the firewall rule applies.
Dest IP	This is the IP address of the computer to which traffic for the application or service is entering.
Source IP	This is the IP address of the computer from which traffic for the application or service is initialized.
Protocol	This is the protocol (TCP , UDP or ICMP) used to transport the packets for which you want to apply the firewall rule.
Dest Port Range	This is the port number/range of the destination that define the traffic type, for example TCP port 80 defines web traffic.
Source Port Range	This is the port number/range of the source that define the traffic type, for example TCP port 80 defines web traffic.
Action	DROP - Traffic matching the conditions of the firewall rule are stopped.
Delete	Click Delete to remove the firewall rule.
Cancel	Click Cancel to start configuring this screen again.

See [Appendix C on page 228](#) for commonly used services and port numbers.

Content Filtering

18.1 Overview

This chapter shows you how to configure content filtering. Content filtering is the ability to block certain web features.

18.2 Content Filter

Use this screen to restrict web features, and designate a trusted computer. Click **Security > Content Filter** to open the **Content Filter** screen.

Figure 90 Security > Content Filter

The following table describes the labels in this screen.

Table 59 Security > Content Filter

LABEL	DESCRIPTION
Trusted IP Setup	To enable this feature, type an IP address of any one of the computers in your network that you want to have as a trusted computer. This allows the trusted computer to have full access to all features that are configured to be blocked by content filtering. Leave this field blank to have no trusted computers.
Restrict Web Features	Select the box(es) to restrict a feature. When you download a page containing a restricted feature, that part of the web page will appear blank or grayed out.
ActiveX	A tool for building dynamic and active Web pages and distributed object applications. When you visit an ActiveX Web site, ActiveX controls are downloaded to your browser, where they remain in case you visit the site again.
Java	A programming language and development environment for building downloadable Web components or Internet and intranet business applications of all kinds.
Cookies	Used by Web servers to track usage and provide service based on ID.

Table 59 Security > Content Filter (continued)

LABEL	DESCRIPTION
Web Proxy	A server that acts as an intermediary between a user and the Internet to provide security, administrative control, and caching service. When a proxy server is located on the WAN it is possible for LAN users to circumvent content filtering by pointing to this proxy server.
Apply	Click Apply to save your changes.
Cancel	Click Cancel to begin configuring this screen afresh

Parental Control

19.1 Overview

Parental controls allow you to block specific URLs. You can also define time periods and days during which the NBG6616 performs parental control on a specific user.

19.1.1 What You Need To Know

The following terms and concepts may help as you read through this chapter.

Keyword Blocking URL Checking

The NBG6616 checks the URL's domain name (or IP address) and file path separately when performing keyword blocking.

The URL's domain name or IP address is the characters that come before the first slash in the URL. For example, with the URL www.zyxel.com.tw/news/pressroom.php, the domain name is www.zyxel.com.tw.

The file path is the characters that come after the first slash in the URL. For example, with the URL www.zyxel.com.tw/news/pressroom.php, the file path is news/pressroom.php.

Since the NBG6616 checks the URL's domain name (or IP address) and file path separately, it will not find items that go across the two. For example, with the URL www.zyxel.com.tw/news/pressroom.php, the NBG6616 would find "tw" in the domain name (www.zyxel.com.tw). It would also find "news" in the file path (news/pressroom.php) but it would not find "tw/news".

19.2 Parental Control Screen

Use this screen to enable parental control, view the parental control rules and schedules.

Click **Configuration > Security > Parental Control** to open the following screen.

Figure 91 Security > Parental Control

The following table describes the fields in this screen.

Table 60 Security > Parental Control

LABEL	DESCRIPTION
Parental Control	Select Enable to activate parental control.
Add new rules	Click this if you want to configure a new parental control rule.
#	This shows the index number of the rule.
Status	This indicates whether the rule is active or not. A yellow bulb signifies that this rule is active. A gray bulb signifies that this rule is not active.
Rule Name	This shows the name of the rule.
Home Network User (MAC)	This shows the MAC address of the LAN user's computer to which this rule applies.
Internet Access Schedule	This shows the day(s) and time on which parental control is enabled.
Network Service	This shows whether the network service is configured. If not, None will be shown.
Website Blocked	This shows whether the website block is configured. If not, None will be shown.
Modify	Click the Edit icon to go to the screen where you can edit the rule. Click the Delete icon to delete an existing rule.
Apply	Click Apply to save your changes.
Cancel	Click Cancel to restore your previously saved settings.

19.2.1 Add/Edit a Parental Control Rule

Click **Add new rules** in the **Parental Control** screen to add a new rule or click the **Edit** icon next to an existing rule to edit it. Use this screen to configure a restricted access schedule and/or URL filtering settings to block the users on your network from accessing certain web sites.

Figure 92 Security > Parental Control: Add/Edit new rules

Parental Control

General

Active

Parental Control Profile Name :

Home Network User :

MAC Address :

Internet Access Schedule

Day : Monday Tuesday Wednesday Thursday
 Friday Saturday Sunday

Time (Begin ~ End) : (hour) (min) ~ (hour) (min)

Network Service

Network Service Setting : selected service

Network Service Rules

#	Service Name	Protocol:Port	Modify

Block Site/URL Keyword

Keyword

Keyword List

The following table describes the fields in this screen.

Table 61 Security > Parental Control: Add/Edit new rules

LABEL	DESCRIPTION
General	
Active	Select the checkbox to activate this parental control rule.
Parental Control Profile Name	Enter a descriptive name for the rule.

Table 61 Security > Parental Control: Add/Edit new rules (continued)

LABEL	DESCRIPTION
Home Network User	Select the LAN user that you want to apply this rule to from the drop-down list box. If you select Custom , enter the LAN user's MAC address. If you select All , the rule applies to all LAN users.
Internet Access Schedule	
Day	Select check boxes for the days that you want the NBG6616 to perform parental control.
Time	Drag the time bar to define the time that the LAN user is allowed access.
Network Service	
Network Service Setting	If you select Block , the NBG6616 prohibits the users from using the services listed below. If you select Allow , the NBG6616 blocks all services except ones listed below.
Add new service	Click this to show a screen in which you can add a new service rule. You can configure the Service Name , Protocol , and Port of the new rule.
#	This shows the index number of the rule. Select the checkbox next to the rule to activate it.
Service Name	This shows the name of the service.
Protocol:Port	This shows the protocol and the port of the service.
Modify	Click the Edit icon to go to the screen where you can edit the rule. Click the Delete icon to delete an existing rule.
Blocked Site/URL Keyword	Click Add to show a screen to enter the website URL or URL keyword to which the NBG6616 blocks access. Click Delete to remove it.
Apply	Click Apply to save your settings back to the NBG6616.
Back	Click Back to return to the previous screen.

19.2.2 Add/Edit a Service

Click **Add new service** in the **Parental Control > Add/Edit new rules** screen to add a new entry or click the **Edit** icon next to an existing entry to edit it. Use this screen to configure a service rule.

Figure 93 Security > Parental Control > Add/Edit new rules > Add/Edit new service

Service Name :

Protocol :

Port :

(Example:4091,5091-6892)

The following table describes the fields in this screen.

Table 62 Security > Parental Control > Add/Edit new rules > Add/Edit new service

LABEL	DESCRIPTION
Service Name	Select the name of the service. Otherwise, select UserDefined and manually specify the protocol and the port of the service.
Protocol	Select the transport layer protocol used for the service. Choices are TCP , UDP , or TCP/UDP . If you have chosen a pre-defined service in the Service Name field, this field will not be configurable.
Port	Enter the port of the service. If you have chosen a pre-defined service in the Service Name field, this field will not be configurable.
Apply	Click Apply to save your settings with the NBG6616.
Back	Click Back to return to the previous screen.

19.3 Technical Reference

The following section contains additional technical information about the NBG6616 features described in this chapter.

19.3.1 Customizing Keyword Blocking URL Checking

You can use commands to set how much of a website's URL the content filter is to check for keyword blocking. See the appendices for information on how to access and use the command interpreter.

Domain Name or IP Address URL Checking

By default, the NBG6616 checks the URL's domain name or IP address when performing keyword blocking.

This means that the NBG6616 checks the characters that come before the first slash in the URL.

For example, with the URL www.zyxel.com.tw/news/pressroom.php, content filtering only searches for keywords within www.zyxel.com.tw.

Full Path URL Checking

Full path URL checking has the NBG6616 check the characters that come before the last slash in the URL.

For example, with the URL www.zyxel.com.tw/news/pressroom.php, full path URL checking searches for keywords within www.zyxel.com.tw/news/.

Use the `ip urlfilter customize actionFlags 6 [disable | enable]` command to extend (or not extend) the keyword blocking search to include the URL's full path.

File Name URL Checking

Filename URL checking has the NBG6616 check all of the characters in the URL.

For example, filename URL checking searches for keywords within the URL www.zyxel.com.tw/news/pressroom.php.

Use the `ip urlfilter customize actionFlags 8 [disable | enable]` command to extend (or not extend) the keyword blocking search to include the URL's complete filename.

IPv6 Firewall

20.1 Overview

This chapter shows you how to enable and create IPv6 firewall rules to block unwanted IPv6 traffic.

20.2 IPv6 Firewall Screen

Click **Configuration > Security > IPv6 Firewall**. The **Service** screen appears as shown.

Figure 94 Configuration > Security > IPv6 Firewall

The screenshot shows the IPv6 Firewall configuration interface. It includes the following elements:

- ICMPv6:** A section with a dropdown menu for "Respond to Ping on" set to "LAN" and an "Apply" button.
- Enable Firewall Rule:** A section with a checked checkbox "Enable Firewall Rule" and an "Apply" button.
- Add Firewall Rule:** A section with input fields for "Service Name", "MAC Address", "Dest_IP_Address", "Source_IP_Address", "Protocol" (set to "TCP"), "DestPortRange", and "SourcePortRange", along with an "Add Rule" button.
- Firewall Rule:** A table with the following columns: #, ServiceName, MACAddress, DestIP, SourceIP, Protocol, DestPortRange, SourcePortRange, Action, and Delete.
- Cancel:** A button at the bottom of the screen.

The following table describes the labels in this screen.

Table 63 Configuration > Security > IPv6 Firewall

LABEL	DESCRIPTION
ICMPv6	Internet Control Message Protocol for IPv6 (ICMPv6 or ICMP for IPv6) is defined in RFC 4443. ICMPv6 has a preceding Next Header value of 58, which is different from the value used to identify ICMP for IPv4. ICMPv6 is an integral part of IPv6. IPv6 nodes use ICMPv6 to report errors encountered in packet processing and perform other diagnostic functions, such as "ping".
Respond to Ping on	The NBG6616 will not respond to any incoming Ping requests when Disable is selected. Select LAN to reply to incoming LAN Ping requests. Select WAN to reply to incoming WAN Ping requests. Otherwise select LAN&WAN to reply to all incoming LAN and WAN Ping requests.
Apply	Click Apply to save the settings.
Enable Firewall Rule	
Enable Firewall Rule	Select this check box to activate the firewall rules that you define (see Add Firewall Rule below).
Apply	Click Apply to save the settings.
Add Firewall Rule	
Service Name	Enter a name that identifies or describes the firewall rule.
MAC Address	Enter the MAC address of the computer for which the firewall rule applies.
Dest_IP_Address	Enter the IPv6 address of the computer to which traffic for the application or service is entering. The NBG6616 applies the firewall rule to traffic destined for this computer.
Source_IP_Address	Enter the IPv6 address of the computer that initializes traffic for the application or service. The NBG6616 applies the firewall rule to traffic initiating from this computer.
Protocol	Select the protocol (TCP , UDP or ICMP) used to transport the packets for which you want to apply the firewall rule.
Dest Port Range	Enter the port number/range of the destination that defines the traffic type, for example TCP port 80 defines web traffic.
Source Port Range	Enter the port number/range of the source that defines the traffic type, for example TCP port 80 defines web traffic.
Add Rule	Click Add Rule to save the firewall rule.
Firewall Rule	
#	This is your firewall rule number. The ordering of your rules is important as rules are applied in turn.
ServiceName	This is a name that identifies or describes the firewall rule.
MACAddress	This is the MAC address of the computer for which the firewall rule applies.
DestIP	This is the IP address of the computer to which traffic for the application or service is entering.
SourceIP	This is the IP address of the computer to which traffic for the application or service is initialized.
Protocol	This is the protocol (TCP , UDP or ICMP) used to transport the packets for which you want to apply the firewall rule.
DestPortRange	This is the port number/range of the destination that defines the traffic type, for example TCP port 80 defines web traffic.
SourcePortRange	This is the port number/range of the source that defines the traffic type, for example TCP port 80 defines web traffic.
Action	DROP - Traffic matching the conditions of the firewall rule is stopped.

Table 63 Configuration > Security > IPv6 Firewall (continued)

LABEL	DESCRIPTION
Delete	Click Delete to remove the firewall rule.
Cancel	Click Cancel to restore your previously saved settings.

Bandwidth Management

21.1 Overview

This chapter contains information about configuring bandwidth management and editing rules.

ZyXEL's Bandwidth Management allows you to specify bandwidth management rules based on an application.

In the figure below, uplink traffic goes from the LAN device (**A**) to the WAN device (**B**). Bandwidth management is applied before sending the packets out to the WAN. Downlink traffic comes back from the WAN device (**B**) to the LAN device (**A**). Bandwidth management is applied before sending the traffic out to LAN.

Figure 95 Bandwidth Management Example

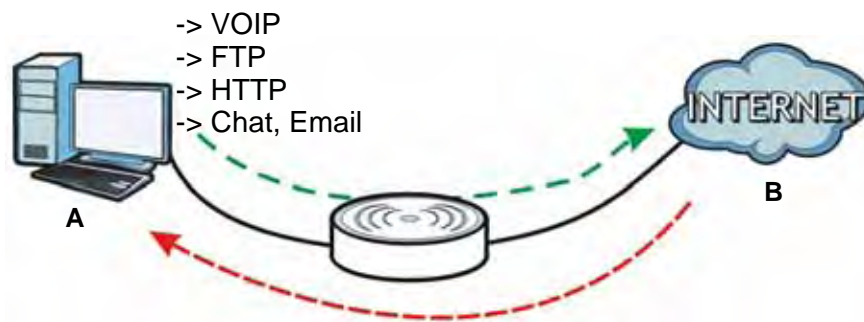

You can allocate specific amounts of bandwidth capacity (bandwidth budgets) to individual applications (like VoIP, Web, FTP, and E-mail for example).

21.2 What You Can Do

- Use the **General** screen to enable bandwidth management and assign bandwidth values ([Section 21.4 on page 148](#)).
- Use the **Advanced** screen to configure bandwidth managements rule for the pre-defined services and applications ([Section 21.5 on page 148](#)).

21.3 What You Need To Know

The sum of the bandwidth allotments that apply to the WAN interface (LAN to WAN, WLAN to WAN) must be less than or equal to the **Upstream Bandwidth** that you configure in the **Bandwidth Management Advanced** screen ([Section 21.5 on page 148](#)).

The sum of the bandwidth allotments that apply to the LAN interface (WAN to LAN, WAN to WLAN) must be less than or equal to the **Downstream Bandwidth** that you configure in the **Bandwidth Management Advanced** screen [Section 21.5 on page 148](#).

21.4 General Screen

Use this screen to have the NBG6616 apply bandwidth management.

Click **Management > Bandwidth MGMT** to open the bandwidth management **General** screen.

Figure 96 Management > Bandwidth Management > General

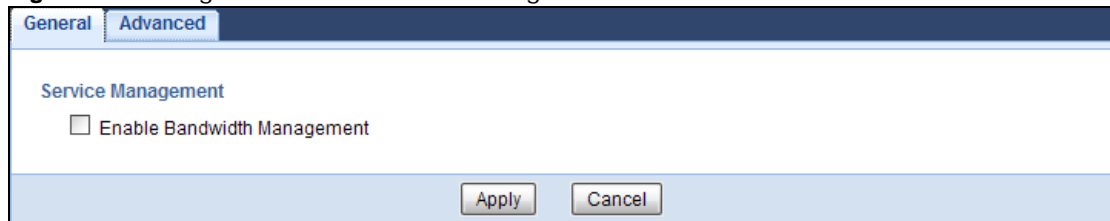

The following table describes the labels in this screen.

Table 64 Management > Bandwidth Management > General

LABEL	DESCRIPTION
Enable Bandwidth Management	This field allows you to have NBG6616 apply bandwidth management. Enable bandwidth management to give traffic that matches a bandwidth rule priority over traffic that does not match a bandwidth rule. Enabling bandwidth management also allows you to control the maximum or minimum amounts of bandwidth that can be used by traffic that matches a bandwidth rule.
Apply	Click Apply to save your customized settings.
Cancel	Click Cancel to begin configuring this screen afresh.

21.5 Advanced Screen

Use this screen to configure bandwidth management rules for the pre-defined services or applications.

You can also use this screen to configure bandwidth management rule for other services or applications that are not on the pre-defined list of NBG6616. Additionally, you can define the source and destination IP addresses and port for a service or application.

Note: The two tables shown in this screen can be configured and applied at the same time.

Click **Management > Bandwidth MGMT > Advanced** to open the bandwidth management **Advanced** screen.

Figure 97 Management > Bandwidth Management > Advanced

General
Advanced

Management Bandwidth

Upstream Bandwidth (Kbps)

Downstream Bandwidth (Kbps)

Application List

#	Priority	Category	Service	
1	High ▼	Game Console	<input type="checkbox"/> Xbox Live <input type="checkbox"/> PlayStation <input type="checkbox"/> MSN Game Zone <input type="checkbox"/> Battlenet	
2	High ▼	VoIP	<input type="checkbox"/> VoIP	
3	High ▼	Instant Messenger	<input type="checkbox"/> Instant Messenger	
4	High ▼	Web Surfing	<input type="checkbox"/> Web Surfing	
5	High ▼	P2P/FTP	<input type="checkbox"/> FTP <input type="checkbox"/> eMule <input type="checkbox"/> BitTorrent	
6	High ▼	E-Mail	<input type="checkbox"/> E-Mail	

User-defined Service

#	Enable	Direction	Service Name	Category	Modify
1	<input type="checkbox"/>	To LAN&WLAN ▼	<input type="text"/>	Game Console ▼	
2	<input type="checkbox"/>	To LAN&WLAN ▼	<input type="text"/>	Game Console ▼	
3	<input type="checkbox"/>	To LAN&WLAN ▼	<input type="text"/>	Game Console ▼	
4	<input type="checkbox"/>	To LAN&WLAN ▼	<input type="text"/>	Game Console ▼	
5	<input type="checkbox"/>	To LAN&WLAN ▼	<input type="text"/>	Game Console ▼	
6	<input type="checkbox"/>	To LAN&WLAN ▼	<input type="text"/>	Game Console ▼	
7	<input type="checkbox"/>	To LAN&WLAN ▼	<input type="text"/>	Game Console ▼	
8	<input type="checkbox"/>	To LAN&WLAN ▼	<input type="text"/>	Game Console ▼	

The following table describes the labels in this screen.

Table 65 Management > Bandwidth Management > Advanced

LABEL	DESCRIPTION
Management Bandwidth	
Upstream Bandwidth	Specify the total amount of bandwidth that you want to dedicate to uplink traffic. The recommendation is to set this to match the actual upstream data rate. This is traffic from LAN/WLAN to WAN.
Downstream Bandwidth	Specify the total amount of bandwidth that you want to dedicate to downlink traffic. The recommendation is to set this to match the actual downstream data rate. This is traffic from WAN to LAN/WLAN.
Application List	Use this table to allocate specific amounts of bandwidth based on a pre-defined service.
#	This is the number of an individual bandwidth management rule.
Priority	Select a priority from the drop down list box. Choose High , Mid or Low . <ul style="list-style-type: none"> • High - Select this for voice traffic or video that is especially sensitive to jitter (jitter is the variations in delay). • Mid - Select this for "excellent effort" or better than best effort and would include important business traffic that can tolerate some delay. • Low - Select this for non-critical "background" traffic such as bulk transfers that are allowed but that should not affect other applications and users.
Category	This is the category where a service belongs.
Service	This is the name of the service. Select the check box to have the NBG6616 apply this bandwidth management rule.
	Click the Edit icon to open the Rule Configuration screen where you can modify the rule.
User-defined Service	Use this table to allocate specific amounts of bandwidth to specific applications or services you specify.
#	This is the number of an individual bandwidth management rule.
Enable	Select this check box to have the NBG6616 apply this bandwidth management rule.
Direction	Select To LAN&WLAN to apply bandwidth management to traffic from WAN to LAN and WLAN. Select To WAN to apply bandwidth management to traffic from LAN/WLAN to WAN.
Service Name	Enter a descriptive name for the bandwidth management rule.
Category	This is the category where a service belongs.
Modify	Click the Edit icon to open the Rule Configuration screen. Modify an existing rule or create a new rule in the Rule Configuration screen. See Section 21.5.2 on page 151 for more information. Click the Remove icon to delete a rule.
Apply	Click Apply to save your customized settings.
Cancel	Click Cancel to begin configuring this screen afresh.

21.5.1 Rule Configuration: Application Rule Configuration

If you want to edit a bandwidth management rule for a pre-defined service or application, click the **Edit** icon in the **Application List** table of the **Advanced** screen. The following screen displays.

Figure 98 Bandwidth Management Rule Configuration: Application List

Rule Configuration- Xbox_Live

#	Enable	Direction	Bandwidth	Destination Port	Source Port	Protocol
1	<input checked="" type="checkbox"/>	LAN/WLAN	Minimum Bandwidth 50 (kbps)	-	-	TCP
2	<input checked="" type="checkbox"/>	LAN/WLAN	Minimum Bandwidth 50 (kbps)	-	-	UDP
3	<input checked="" type="checkbox"/>	WAN	Minimum Bandwidth 10 (kbps)	-	-	TCP
4	<input checked="" type="checkbox"/>	WAN	Minimum Bandwidth 10 (kbps)	-	-	UDP

Apply Cancel

The following table describes the labels in this screen.

Table 66 Bandwidth Management Rule Configuration: Application List

LABEL	DESCRIPTION
#	This is the number of an individual bandwidth management rule.
Enable	Select an interface's check box to enable bandwidth management on that interface.
Direction	These read-only labels represent the physical interfaces. Bandwidth management applies to all traffic flowing out of the router through the interface, regardless of the traffic's source. Traffic redirect or IP alias may cause LAN-to-LAN traffic to pass through the NBG6616 and be managed by bandwidth management.
Bandwidth	Select Maximum Bandwidth or Minimum Bandwidth and specify the maximum or minimum bandwidth allowed for the rule in kilobits per second.
Destination Port	This is the port number of the destination that define the traffic type, for example TCP port 80 defines web traffic. See Appendix C on page 228 for some common services and port numbers.
Source Port	This is the port number of the source that define the traffic type, for example TCP port 80 defines web traffic. See Appendix C on page 228 for some common services and port numbers.
Protocol	This is the protocol (TCP , UDP or user-defined) used for the service.
Apply	Click Apply to save your customized settings.
Cancel	Click Cancel to exit this screen without saving.

21.5.2 Rule Configuration: User Defined Service Rule Configuration

If you want to edit a bandwidth management rule for other applications or services, click the **Edit** icon in the **User-defined Service** table of the **Advanced** screen. The following screen displays.

Figure 99 Bandwidth Management Rule Configuration: User-defined Service

Rule Configuration> -

BW Budget: Minimum Bandwidth ▼ 10 (kbps)

Destination Address Start: 0.0.0.0

Destination Address End: 0.0.0.0

Destination Port: 0

Source Address Start: 0.0.0.0

Source Address End: 0.0.0.0

Source Port: 0

Protocol: TCP ▼

Apply Cancel

The following table describes the labels in this screen.

Table 67 Bandwidth Management Rule Configuration: User-defined Service

LABEL	DESCRIPTION
BW Budget	Select Maximum Bandwidth or Minimum Bandwidth and specify the maximum or minimum bandwidth allowed for the rule in kilobits per second.
Destination Address Start	Enter the starting IP address of the destination computer. The NBG6616 applies bandwidth management to the service or application that is entering this computer.
Destination Address End	Enter the ending IP address of the destination computer. The NBG6616 applies bandwidth management to the service or application that is entering this computer.
Destination Port	This is the port number of the destination that define the traffic type, for example TCP port 80 defines web traffic.
Source Address Start	Enter the starting IP address of the computer that initializes traffic for the application or service. The NBG6616 applies bandwidth management to traffic initiating from this computer.
Source Address End	Enter the ending IP address of the computer that initializes traffic for the application or service. The NBG6616 applies bandwidth management to traffic initiating from this computer.
Source Port	This is the port number of the source that define the traffic type, for example TCP port 80 defines web traffic.
Protocol	Select the protocol (TCP , UDP , BOTH) for which the bandwidth management rule applies. If you select BOTH , enter the protocol for which the bandwidth management rule applies. For example, ICMP for ping traffic.
Apply	Click Apply to save your customized settings.
Cancel	Click Cancel to exit this screen without saving.

See [Appendix C on page 228](#) for commonly used services and port numbers.

21.5.3 Predefined Bandwidth Management Services

The following is a description of some services that you can select and to which you can apply media bandwidth management in the **Management > Bandwidth MGMT > Advanced** screen.

Table 68 Media Bandwidth Management Setup: Services

SERVICE	DESCRIPTION
FTP	File Transfer Program enables fast transfer of files, including large files that may not be possible by e-mail.
WWW	The World Wide Web (WWW) is an Internet system to distribute graphical, hyper-linked information, based on Hyper Text Transfer Protocol (HTTP) - a client/server protocol for the World Wide Web. The Web is not synonymous with the Internet; rather, it is just one service on the Internet. Other services on the Internet include Internet Relay Chat and Newsgroups. The Web is accessed through use of a browser.
E-Mail	Electronic mail consists of messages sent through a computer network to specific groups or individuals. Here are some default ports for e-mail: <ul style="list-style-type: none"> • POP3 - port 110 • IMAP - port 143 • SMTP - port 25 • HTTP - port 80
VoIP (SIP)	Sending voice signals over the Internet is called Voice over IP or VoIP. Session Initiated Protocol (SIP) is an internationally recognized standard for implementing VoIP. SIP is an application-layer control (signaling) protocol that handles the setting up, altering and tearing down of voice and multimedia sessions over the Internet. SIP is transported primarily over UDP but can also be transported over TCP.
BitTorrent	BitTorrent is a free P2P (peer-to-peer) sharing tool allowing you to distribute large software and media files. BitTorrent requires you to search for a file with a searching engine yourself. It distributes files by corporation and trading, that is, the client downloads the file in small pieces and share the pieces with other peers to get other half of the file.
Gaming	Online gaming services lets you play multiplayer games on the Internet via broadband technology. As of this writing, your NBG6616 supports Xbox, Playstation, Battlenet and MSN Game Zone.

Remote Management

22.1 Overview

This chapter provides information on the Remote Management screens.

Remote Management allows you to manage your NBG6616 from a remote location through the following interfaces:

- LAN and WAN
- LAN only
- WAN only

Note: The NBG6616 is managed using the Web Configurator.

22.2 What You Can Do in this Chapter

- Use the **WWW** screen to define the interface/s from which the NBG6616 can be managed remotely using the web and specify a secure client that can manage the NBG6616 ([Section 22.4 on page 155](#)).
- Use the **Telnet** screen to define the interface/s from which the NBG6616 can be managed remotely using Telnet service and specify a secure client that can manage the NBG6616 ([Section 22.5 on page 156](#)).
- Use the **Wake On LAN** screen to enable Wake on LAN and remotely turn on a device on the local network ([Section 22.6 on page 156](#)).

22.3 What You Need to Know

Remote management over LAN or WAN will not work when:

- 1 The IP address in the **Secured Client IP Address** field ([Section 22.4 on page 155](#)) does not match the client IP address. If it does not match, the NBG6616 will disconnect the session immediately.
- 2 There is already another remote management session. You may only have one remote management session running at one time.
- 3 There is a firewall rule that blocks it.

22.3.1 Remote Management and NAT

When NAT is enabled:

- Use the NBG6616's WAN IP address when configuring from the WAN.
- Use the NBG6616's LAN IP address when configuring from the LAN.

22.3.2 System Timeout

There is a default system management idle timeout of five minutes (three hundred seconds). The NBG6616 automatically logs you out if the management session remains idle for longer than this timeout period. The management session does not time out when a statistics screen is polling. You can change the timeout period in the **Maintenance > General** screen

22.4 WWW Screen

To change your NBG6616's remote management settings, click **Management > Remote MGMT > WWW**.

Figure 100 Management > Remote Management > WWW

The following table describes the labels in this screen.

Table 69 Management > Remote Management > WWW

LABEL	DESCRIPTION
Port	You may change the server port number for a service if needed, however you must use the same port number in order to use that service for remote management.
Access Status	Select the interface(s) through which a computer may access the NBG6616 using this service.
Secured Client IP Address	Select All to allow all computers to access the NBG6616. Otherwise, check Selected and specify the IP address of the computer that can access the NBG6616.
Apply	Click Apply to save your customized settings.
Cancel	Click Cancel to begin configuring this screen afresh.

22.5 Telnet Screen

To change your NBG6616's remote management settings, click **Management > Remote MGMT > Telnet** to open the **Telnet** screen.

Figure 101 Management > Remote MGMT > Telnet

The following table describes the labels in this screen.

Table 70 Management > Remote MGMT > Telnet

LABEL	DESCRIPTION
Port	You may change the server port number for a service if needed, however you must use the same port number in order to use that service for remote management.
Access Status	Select the interface(s) through which a computer may access the NBG6616 using this service.
Secured Client IP Address	Select All to allow all computers to access the NBG6616. Otherwise, check Selected and specify the IP address of the computer that can access the NBG6616.
Apply	Click Apply to save your customized settings.
Cancel	Click Cancel to begin configuring this screen afresh.

22.6 Wake On LAN Screen

Wake On LAN (WoL) allows you to remotely turn on a device on the network, such as a computer, storage device or media server. To use this feature the remote hardware (for example the network adapter on a computer) must support Wake On LAN using the "Magic Packet" method.

You need to know the MAC address of the remote device. It may be on a label on the device.

Use this screen to remotely turn on a device on the network. Click the **Management > Remote MGMT > Wake On LAN** to open the following screen.

Figure 102 Management > Remote MGMT > Wake On LAN

The following table describes the labels in this screen.

Table 71 Management > Remote MGMT > Wake On LAN

LABEL	DESCRIPTION
Wake On LAN over WAN Settings	
Enable WOL over WAN	Select this option to have the NBG6616 forward a WoL “Magic Packet” to all devices on the LAN if the packet comes from the WAN or remote network and uses the port number specified in the Port field. A LAN device whose hardware supports Wake on LAN then will be powered on if it is turned off previously.
Port	Type a port number from which a WoL packet is forwarded to the LAN.
Wake On LAN	
Wake MAC Address	Enter the MAC Address of the device on the network that will be turned on. A MAC address consists of six hexadecimal character pairs.
Start	Click this to have the NBG6616 generate a WoL packet and forward it to turn the specified device on. A screen pops up displaying MAC address error if you input the MAC address incorrectly.
Apply	Click Apply to save the setting to the NBG6616.
Cancel	Click Cancel to begin configuring this screen afresh.

Universal Plug-and-Play (UPnP)

23.1 Overview

This chapter introduces the UPnP feature in the web configurator.

Universal Plug and Play (UPnP) is a distributed, open networking standard that uses TCP/IP for simple peer-to-peer network connectivity between devices. A UPnP device can dynamically join a network, obtain an IP address, convey its capabilities and learn about other devices on the network. In turn, a device can leave a network smoothly and automatically when it is no longer in use.

23.2 What You Need to Know

UPnP hardware is identified as an icon in the Network Connections folder (Windows XP). Each UPnP compatible device installed on your network will appear as a separate icon. Selecting the icon of a UPnP device will allow you to access the information and properties of that device.

23.2.1 NAT Traversal

UPnP NAT traversal automates the process of allowing an application to operate through NAT. UPnP network devices can automatically configure network addressing, announce their presence in the network to other UPnP devices and enable exchange of simple product and service descriptions. NAT traversal allows the following:

- Dynamic port mapping
- Learning public IP addresses
- Assigning lease times to mappings

Windows Messenger is an example of an application that supports NAT traversal and UPnP.

See the NAT chapter for more information on NAT.

23.2.2 Cautions with UPnP

The automated nature of NAT traversal applications in establishing their own services and opening firewall ports may present network security issues. Network information and configuration may also be obtained and modified by users in some network environments.

When a UPnP device joins a network, it announces its presence with a multicast message. For security reasons, the NBG6616 allows multicast messages on the LAN only.

All UPnP-enabled devices may communicate freely with each other without additional configuration. Disable UPnP if this is not your intention.

23.3 UPnP Screen

Use this screen to enable UPnP on your NBG6616.

Click **Management** > **UPnP** to display the screen shown next.

Figure 103 Management > UPnP

The following table describes the fields in this screen.

Table 72 Management > UPnP

LABEL	DESCRIPTION
UPnP	Select Enable to activate UPnP. Be aware that anyone could use a UPnP application to open the web configurator's login screen without entering the NBG6616's IP address (although you must still enter the password to access the web configurator).
Apply	Click Apply to save the setting to the NBG6616.
Cancel	Click Cancel to return to the previously saved settings.

23.4 Technical Reference

The sections show examples of using UPnP.

23.4.1 Using UPnP in Windows XP Example

This section shows you how to use the UPnP feature in Windows XP. You must already have UPnP installed in Windows XP and UPnP activated on the NBG6616.

Make sure the computer is connected to a LAN port of the NBG6616. Turn on your computer and the NBG6616.

23.4.1.1 Auto-discover Your UPnP-enabled Network Device

- 1 Click **start** and **Control Panel**. Double-click **Network Connections**. An icon displays under Internet Gateway.
- 2 Right-click the icon and select **Properties**.

Figure 104 Network Connections



- 3 In the **Internet Connection Properties** window, click **Settings** to see the port mappings there were automatically created.

Figure 105 Internet Connection Properties



- 4 You may edit or delete the port mappings or click **Add** to manually add port mappings.

Figure 106 Internet Connection Properties: Advanced Settings



Figure 107 Internet Connection Properties: Advanced Settings: Add

Note: When the UPnP-enabled device is disconnected from your computer, all port mappings will be deleted automatically.

- 5 Select **Show icon in notification area when connected** option and click **OK**. An icon displays in the system tray.

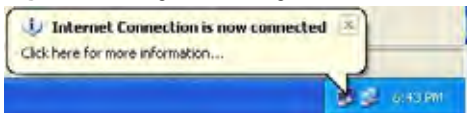
Figure 108 System Tray Icon

- 6 Double-click on the icon to display your current Internet connection status.

Figure 109 Internet Connection Status

23.4.2 Web Configurator Easy Access

With UPnP, you can access the web-based configurator on the NBG6616 without finding out the IP address of the NBG6616 first. This comes helpful if you do not know the IP address of the NBG6616.

Follow the steps below to access the web configurator.

- 1 Click **Start** and then **Control Panel**.
- 2 Double-click **Network Connections**.

- 3 Select **My Network Places** under **Other Places**.

Figure 110 Network Connections

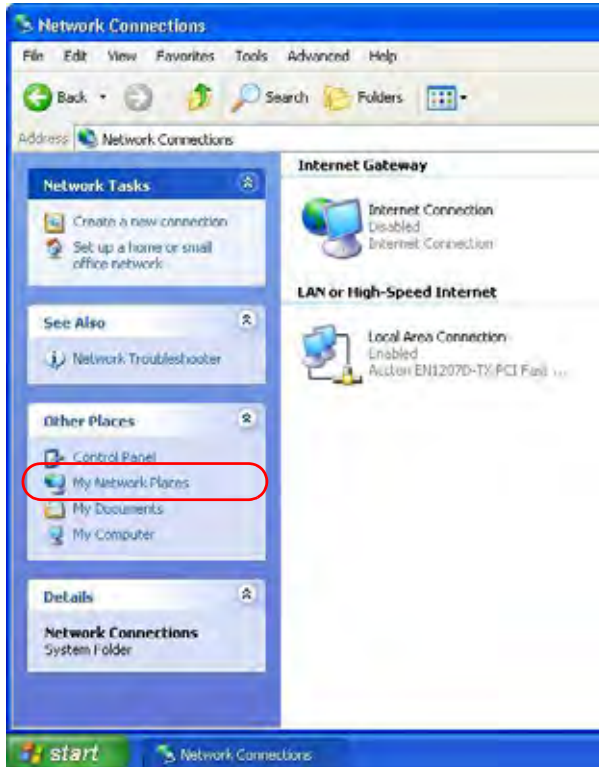

- 4 An icon with the description for each UPnP-enabled device displays under **Local Network**.
- 5 Right-click on the icon for your NBG6616 and select **Invoke**. The web configurator login screen displays.

Figure 111 Network Connections: My Network Places

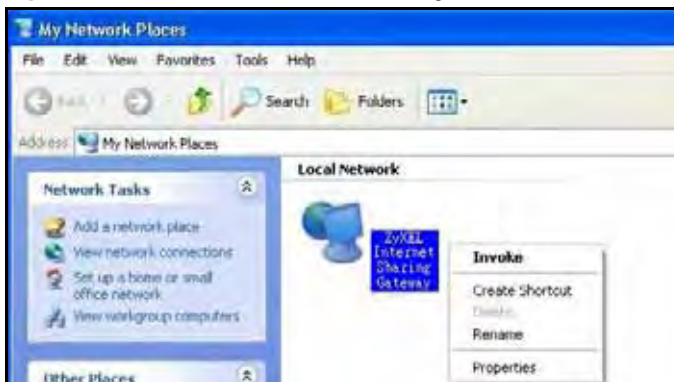

- 6 Right-click on the icon for your NBG6616 and select **Properties**. A properties window displays with basic information about the NBG6616.

Figure 112 Network Connections: My Network Places: Properties: Example



USB Media Sharing

24.1 Overview

This chapter describes how to configure the media sharing settings on the NBG6616.

Note: The read and write performance may be affected by amount of file-sharing traffic on your network, type of connected USB device and your USB version (1.1 or 2.0).

Media Server

You can set up your NBG6616 to act as a media server to provide media (like video) to DLNA-compliant players, such as Windows Media Player, ZyXEL DMAs (Digital Media Adapters), Xboxes or PS3s. The media server and clients must have IP addresses in the same subnet.

The NBG6616 media server enables you to:

- Publish all folders for everyone to play media files in the USB storage device connected to the NBG6616.
- Use hardware-based media clients like the DMA-2500 to play the files.

Note: Anyone on your network can play the media files in the published folders. No user name and password nor other form of security is required.

The following figure is an overview of the NBG6616's media server feature. DLNA devices **A** and **B** can access and play files on a USB device (**C**) which is connected to the NBG6616 (**D**).

Figure 113 Media Server Overview

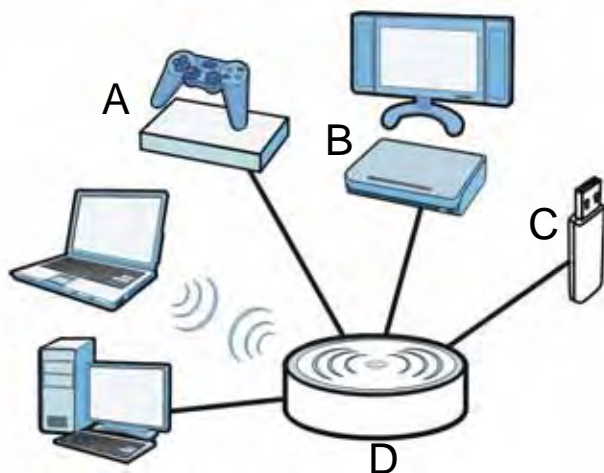

File-Sharing Server

You can also share files on a USB memory stick or hard drive connected to your NBG6616 with users on your network.

The following figure is an overview of the NBG6616's file-sharing server feature. Computers **A** and **B** can access files on a USB device (**C**) which is connected to the NBG6616 (**D**).

Figure 114 File Sharing Overview



24.2 What You Can Do

- Use the **DLNA** screen to use the NBG6616 as a media server and allow DLNA-compliant devices to play media files stored in the attached USB device ([Section 24.5 on page 167](#)).
- Use the **SAMBA** screen to enable file-sharing via the NBG6616 using Windows Explorer or the workgroup name. This screen also allow you to configure the workgroup name and create user accounts ([Section 24.6 on page 167](#)).
- Use the **FTP** screen to allow file sharing via the NBG6616 using FTP and create user accounts ([Section 24.7 on page 169](#)).

24.3 What You Need To Know

DLNA

The Digital Living Network Alliance (DLNA) is a group of personal computer and electronics companies that works to make products compatible in a home network. DLNA clients play files stored on DLNA servers. The NBG6616 can function as a DLNA-compliant media server and stream files to DLNA-compliant media clients without any configuration.

Workgroup name

This is the name given to a set of computers that are connected on a network and share resources such as a printer or files. Windows automatically assigns the workgroup name when you set up a network.

File Systems

A file system is a way of storing and organizing files on your hard drive and storage device. Often different operating systems such as Windows or Linux have different file systems. The file-sharing feature on your NBG6616 supports New Technology File System (NTFS), File Allocation Table (FAT) and FAT32 file systems.

Windows/CIFS

Common Internet File System (CIFS) is a standard protocol supported by most operating systems in order to share files across the network.

CIFS runs over TCP/IP but uses the SMB (Server Message Block) protocol found in Microsoft Windows for file and printer access; therefore, CIFS will allow all applications, not just Web browsers, to open and share files across the Internet.

The NBG6616 uses Common Internet File System (CIFS) protocol for its file sharing functions. CIFS compatible computers can access the USB file storage devices connected to the NBG6616. CIFS protocol is supported on Microsoft Windows, Linux Samba and other operating systems (refer to your systems specifications for CIFS compatibility).

Samba

SMB is a client-server protocol used by Microsoft Windows systems for sharing files, printers, and so on.

Samba is a free SMB server that runs on most Unix and Unix-like systems. It provides an implementation of an SMB client and server for use with non-Microsoft operating systems.

File Transfer Protocol

This is a method of transferring data from one computer to another over a network such as the Internet.

24.4 Before You Begin

Make sure the NBG6616 is connected to your network and turned on.

- 1 Connect the USB device to one of the NBG6616's USB ports.
- 2 The NBG6616 detects the USB device and makes its contents available for browsing. If you are connecting a USB hard drive that comes with an external power supply, make sure it is connected to an appropriate power source that is on.

Note: If your USB device cannot be detected by the NBG6616, see the troubleshooting for suggestions.

24.5 DLNA Screen

Use this screen to have the NBG6616 act as a DLNA-compliant media server that lets DLNA-compliant media clients on your network play video, music, and photos from the NBG6616 (without having to copy them to another computer). Click **Management > USB Media Sharing > DLNA**.

Figure 115 Management > USB Media Sharing > DLNA

The following table describes the labels in this screen.

Table 73 Management > USB Media Sharing > DLNA

LABEL	DESCRIPTION
Enable DLNA	Select this to have the NBG6616 function as a DLNA-compliant media server.
USB1/2	Select the media type that you want to share on the USB device connected to the NBG6616's USB port.
Rescan	Click this button to have the NBG6616 scan the media files on the connected USB device and do indexing of the file list again so that DLNA clients can find the new files if any.
Apply	Click Apply to save your changes back to the NBG6616.
Cancel	Click Cancel to begin configuring this screen afresh.

24.6 SAMBA Screen

Use this screen to set up file-sharing via the NBG6616 using Windows Explorer or the workgroup name. You can also configure the workgroup name and create file-sharing user accounts. Click **Management > USB Media Sharing > SAMBA**.

Figure 116 Management > USB Media Sharing > SAMBA

The following table describes the labels in this screen.

Table 74 Management > USB Media Sharing > SAMBA

LABEL	DESCRIPTION
Enable SAMBA	Select this to enable file sharing through the NBG6616 using Windows Explorer or by browsing to your work group.
Name	Specify the name to identify the NBG6616 in a work group.
Work Group	You can add the NBG6616 to an existing or a new workgroup on your network. Enter the name of the workgroup which your NBG6616 automatically joins. You can set the NBG6616's workgroup name to be exactly the same as the workgroup name to which your computer belongs to. Note: The NBG6616 will not be able to join the workgroup if your local area network has restrictions set up that do not allow devices to join a workgroup. In this case, contact your network administrator.
Description	Enter the description of the NBG6616 in a work group.
USB1/2	Specify the user's access rights to the USB storage device which is connected to the NBG6616's USB port. Read & Write - The user has read and write rights, meaning that the user can create and edit the files on the connected USB device. Read - The user has read rights only and can not create or edit the files on the connected USB device.
User Accounts	Before you can share files you need a user account. Configure the following fields to set up a file-sharing account.
#	This is the index number of the user account.

Table 74 Management > USB Media Sharing > SAMBA (continued)

LABEL	DESCRIPTION
Enable	This field displays whether a user account is activated or not. Select the check box to enable the account. Clear the check box to disable the account.
User Name	Enter a user name that will be allowed to access the shared files. You can enter up to 20 characters. Only letters and numbers allowed.
Password	Enter the password used to access the shared files. You can enter up to 20 characters. Only letters and numbers are allowed. The password is case sensitive.
USB1/2	Select the USB port(s) of the NBG6616. The configured user can access the files on the USB device(s) connected to the selected USB port(s) only.
Apply	Click Apply to save your changes back to the NBG6616.
Cancel	Click Cancel to begin configuring this screen afresh.

24.7 FTP Screen

Use this screen to set up file sharing via the NBG6616 using FTP and create user accounts. Click **Management > USB Media Sharing > FTP**.

Figure 117 Management > USB Media Sharing > FTP

#	Enable	User Name	Password	USB1	USB2	Upstream Bandwidth	Downstream Bandwidth
1	<input checked="" type="checkbox"/>	andrea	••••	Read	Read	1000	1000
2	<input type="checkbox"/>			None	None		
3	<input type="checkbox"/>			None	None		
4	<input type="checkbox"/>			None	None		
5	<input type="checkbox"/>			None	None		

The following table describes the labels in this screen.

Table 75 Management > USB Media Sharing > FTP

LABEL	DESCRIPTION
Enable FTP	Select this to enable the FTP server on the NBG6616 for file sharing using FTP.
Port	You may change the server port number for FTP if needed, however you must use the same port number in order to use that service for file sharing.
User Accounts	Before you can share files you need a user account. Configure the following fields to set up a file-sharing account.
#	This is the index number of the user account.

Table 75 Management > USB Media Sharing > FTP (continued)

LABEL	DESCRIPTION
Enable	This field displays whether a user account is activated or not. Select the check box to enable the account. Clear the check box to disable the account.
User Name	Enter a user name that will be allowed to access the shared files. You can enter up to 20 characters. Only letters and numbers allowed.
Password	Enter the password used to access the shared files. You can enter up to 20 characters. Only letters and numbers are allowed. The password is case sensitive.
USB1/2	Specify the user's access rights to the USB storage device which is connected to the NBG6616's USB port. Read & Write - The user has read and write rights, meaning that the user can create and edit the files on the connected USB device. Read - The user has read rights only and can not create or edit the files on the connected USB device. None - The user cannot access the files on the USB device(s) connected to the USB port.
Upstream Bandwidth	Enter the maximum bandwidth (in Kbps) allowed for incoming FTP traffic.
Downstream Bandwidth	Enter the maximum bandwidth (in Kbps) allowed for outgoing FTP traffic.
Apply	Click Apply to save your changes back to the NBG6616.
Cancel	Click Cancel to begin configuring this screen afresh.

24.8 Example of Accessing Your Shared Files From a Computer

You can use Windows Explorer or FTP to access the USB storage devices connected to the NBG6616.

This example shows you how to use Microsoft's Windows XP to browse your shared files. Refer to your operating system's documentation for how to browse your file structure.

24.8.1 Use Windows Explorer to Share Files

You should have enabled file sharing and create a user account (Bob/1234 for example) with read and write access to USB 1 in the **USB Media Sharing > SAMBA** screen.

Open Windows Explorer to access the connected USB device using either Windows Explorer browser or by browsing to your workgroup.

- 1 In Windows Explorer's Address bar type a double backslash “\\” followed by the IP address of the NBG6616 (the default IP address of the NBG6616 in router mode is 192.168.1.1) and press [ENTER]. A screen asking for password authentication appears. Type the user name and password (Bob and 1234 in this example) and click **OK**.

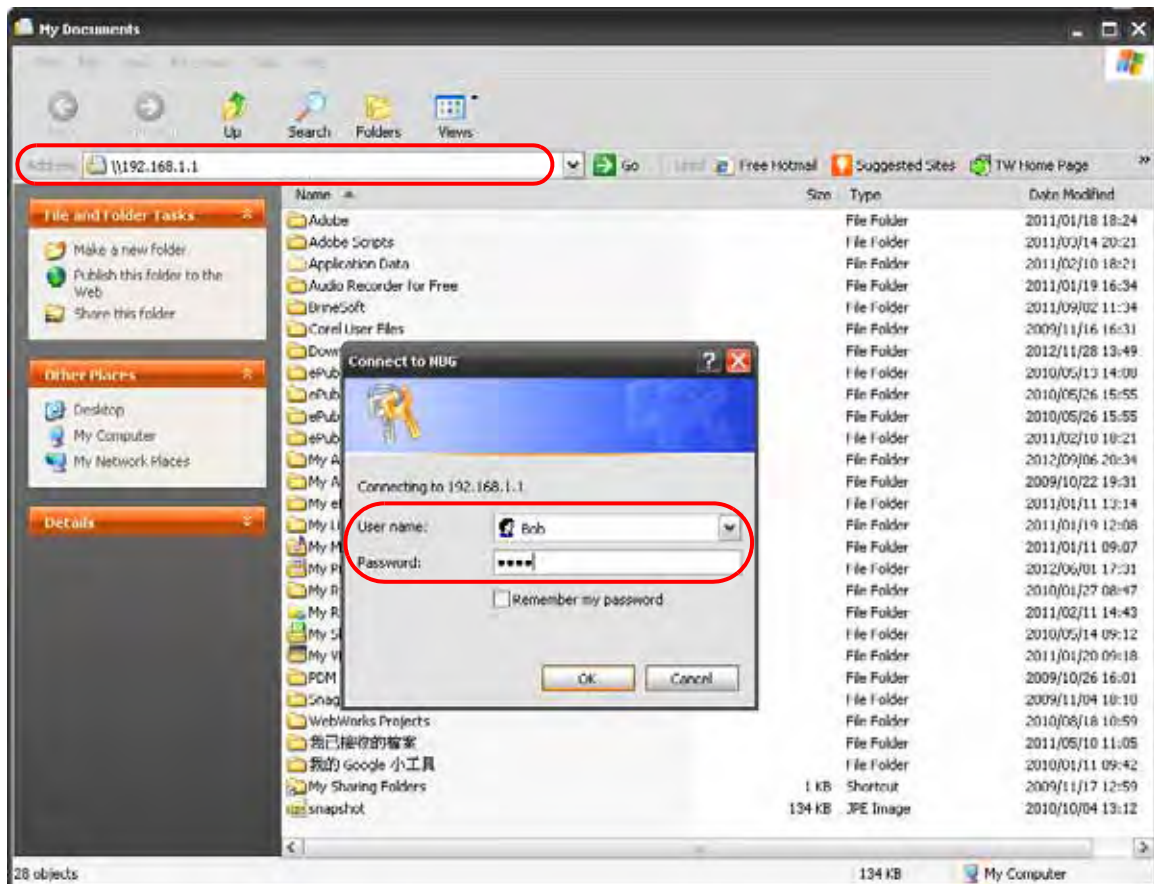

Note: Once you log into the shared folder via your NBG6616, you do not have to relogin unless you restart your computer.

- 2 You can also use the workgroup name to access files by browsing to the workgroup folder using the folder tree on the left side of the screen. It is located under **My Network Places**. In this example the workgroup name is the default "Workgroup".

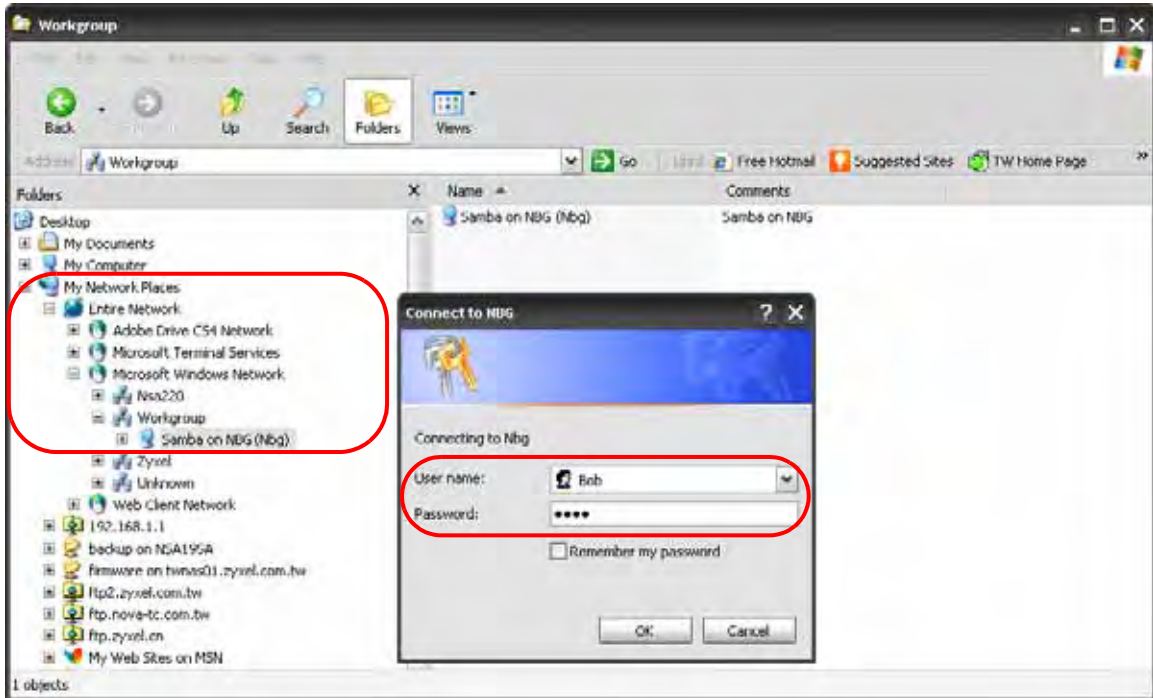

24.8.2 Use FTP to Share Files

You can use FTP to access the USB storage devices connected to the NBG6616. In this example, we use the web browser to share files via FTP from the LAN. The way or screen you log into the FTP server (on the NBG6616) varies depending on your FTP client. See your FTP client documentation for more information.

You should have enabled file sharing and create a user account (Bob/1234 for example) with read and write access to USB 1 in the **USB Media Sharing > FTP** screen.

- 1 In your web browser's address or URL bar type "ftp://" followed by the IP address of the NBG6616 (the default LAN IP address of the NBG6616 in router mode is 192.168.1.1) and click **Go** or press [ENTER].

- 2 A screen asking for password authentication appears. Enter the user name and password (you configured in the **USB Media Sharing > FTP** screen) and click **Log On**.

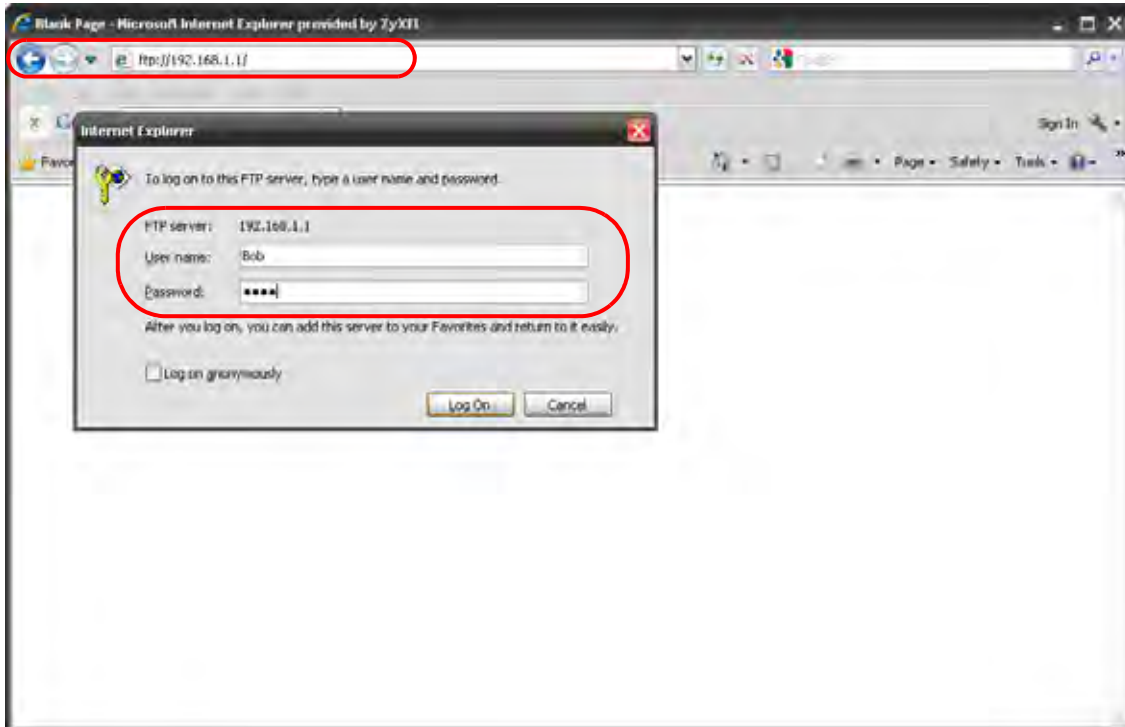

- 3 The screen changes and shows you the folder for the USB storage device connected to your NBG6616. Double-click the folder to display the contents in it.



Maintenance

25.1 Overview

This chapter provides information on the **Maintenance** screens.

25.2 What You Can Do

- Use the **General** screen to set the timeout period of the management session ([Section 25.3 on page 174](#)).
- Use the **Password** screen to change your NBG6616's system password ([Section 25.4 on page 175](#)).
- Use the **Time** screen to change your NBG6616's time and date ([Section 25.5 on page 176](#)).
- Use the **Firmware Upgrade** screen to upload firmware to your NBG6616 ([Section 25.6 on page 177](#)).
- Use the **Backup/Restore** screen to view information related to factory defaults, backup configuration, and restoring configuration ([Section 25.8 on page 180](#)).
- Use the **Restart** screen to reboot the NBG6616 without turning the power off ([Section 25.8 on page 180](#)).
- Use the **Language** screen to change the language for the Web Configurator ([Section 25.9 on page 180](#)).
- Use the **Sys OP Mode** screen to select how you want to use your NBG6616 ([Section 25.11 on page 182](#)).

25.3 General Screen

Use this screen to set the management session timeout period. Click **Maintenance > General**. The following screen displays.

Figure 118 Maintenance > General

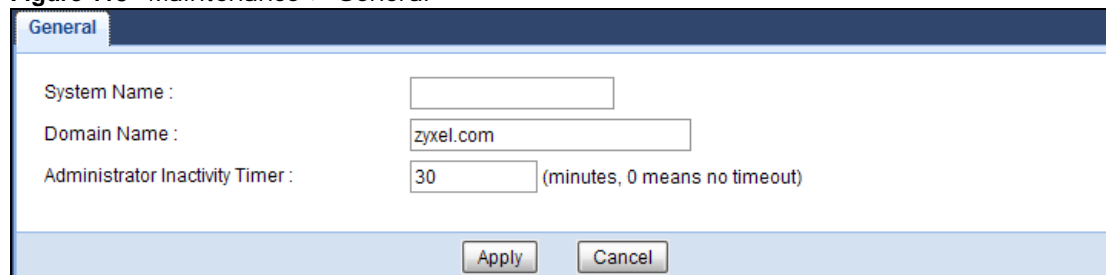

The screenshot shows a web configuration interface for the 'General' screen. It features three input fields: 'System Name' (empty), 'Domain Name' (containing 'zyxel.com'), and 'Administrator Inactivity Timer' (containing '30'). A note next to the timer field states '(minutes, 0 means no timeout)'. At the bottom, there are 'Apply' and 'Cancel' buttons.

The following table describes the labels in this screen.

Table 76 Maintenance > General

LABEL	DESCRIPTION
System Name	System Name is a unique name to identify the NBG6616 in an Ethernet network.
Domain Name	Enter the domain name you want to give to the NBG6616.
Administrator Inactivity Timer	Type how many minutes a management session can be left idle before the session times out. The default is 5 minutes. After it times out you have to log in with your password again. Very long idle timeouts may have security risks. A value of "0" means a management session never times out, no matter how long it has been left idle (not recommended).
Apply	Click Apply to save your changes back to the NBG6616.
Cancel	Click Cancel to begin configuring this screen afresh.

25.4 Password Screen

It is strongly recommended that you change your NBG6616's password.

If you forget your NBG6616's password (or IP address), you will need to reset the device. See [Section 25.8 on page 180](#) for details.

Click **Maintenance > Password**. The screen appears as shown.

Figure 119 Maintenance > Password

The following table describes the labels in this screen.

Table 77 Maintenance > Password

LABEL	DESCRIPTION
Password Setup	Change your NBG6616's password (recommended) using the fields as shown.
Old Password	Type the default password or the existing password you use to access the system in this field.
New Password	Type your new system password (up to 30 characters). Note that as you type a password, the screen displays an asterisk (*) for each character you type.
Retype to Confirm	Type the new password again in this field.
Apply	Click Apply to save your changes back to the NBG6616.
Cancel	Click Cancel to begin configuring this screen afresh.

25.5 Time Setting Screen

Use this screen to configure the NBG6616's time based on your local time zone. To change your NBG6616's time and date, click **Maintenance** > **Time**. The screen appears as shown.

Figure 120 Maintenance > Time

The screenshot shows the 'Time Setting' interface. It is divided into three main sections: 'Current Time and Date', 'Time and Date Setup', and 'Time Zone Setup'.
 - **Current Time and Date:** Shows 'Current Time : 09:48:27' and 'Current Date : 2014-03-24'.
 - **Time and Date Setup:** Features two radio buttons: 'Manual' (unselected) and 'Get from Time Server' (selected). Under 'Manual', there are input fields for 'New Time (hh:mm:ss) : 00 : 00 : 00' and 'New Date (yyy/mm/dd) : 2014 / 01 / 01'. Under 'Get from Time Server', there is a text field for 'User Defined Time Server Address : pool.ntp.org'.
 - **Time Zone Setup:** Includes a dropdown menu for 'Time Zone : (GMT) Greenwich Mean Time : Dublin, Edinburgh, Lisbon, London'. Below it is a checkbox for 'Daylight Savings' which is unchecked. There are also dropdown menus for 'Start Date' (First, Sunday, of, January, at 00 o'clock) and 'End Date' (First, Sunday, of, February, at 00 o'clock).
 At the bottom, there are 'Apply' and 'Cancel' buttons.

The following table describes the labels in this screen.

Table 78 Maintenance > Time

LABEL	DESCRIPTION
Current Time and Date	
Current Time	This field displays the time of your NBG6616. Each time you reload this page, the NBG6616 synchronizes the time with the time server.
Current Date	This field displays the date of your NBG6616. Each time you reload this page, the NBG6616 synchronizes the date with the time server.
Current Time and Date	
Manual	Select this radio button to enter the time and date manually. If you configure a new time and date, Time Zone and Daylight Saving at the same time, the new time and date you entered has priority and the Time Zone and Daylight Saving settings do not affect it.
New Time (hh:mm:ss)	This field displays the last updated time from the time server or the last time configured manually. When you select Manual , enter the new time in this field and then click Apply .

Table 78 Maintenance > Time (continued)

LABEL	DESCRIPTION
New Date (yyyy/mm/dd)	This field displays the last updated date from the time server or the last date configured manually. When you select Manual , enter the new date in this field and then click Apply .
Get from Time Server	Select this radio button to have the NBG6616 get the time and date from the time server you specified below.
User Defined Time Server Address	Select User Defined Time Server Address and enter the IP address or URL (up to 20 extended ASCII characters in length) of your time server. Check with your ISP/network administrator if you are unsure of this information.
Time Zone Setup	
Time Zone	Choose the time zone of your location. This will set the time difference between your time zone and Greenwich Mean Time (GMT).
Daylight Savings	Daylight saving is a period from late spring to early fall when many countries set their clocks ahead of normal local time by one hour to give more daytime light in the evening. Select this option if you use Daylight Saving Time.
Start Date	Configure the day and time when Daylight Saving Time starts if you selected Daylight Savings . The at field uses the 24 hour format. Here are a couple of examples: Daylight Saving Time starts in most parts of the United States on the second Sunday of March. Each time zone in the United States starts using Daylight Saving Time at 2 A.M. local time. So in the United States you would select Second, Sunday, March and select 2 in the at field. Daylight Saving Time starts in the European Union on the last Sunday of March. All of the time zones in the European Union start using Daylight Saving Time at the same moment (1 A.M. GMT or UTC). So in the European Union you would select Last, Sunday, March . The time you select in the at field depends on your time zone. In Germany for instance, you would select 2 because Germany's time zone is one hour ahead of GMT or UTC (GMT+1).
End Date	Configure the day and time when Daylight Saving Time ends if you selected Daylight Savings . The at field uses the 24 hour format. Here are a couple of examples: Daylight Saving Time ends in the United States on the first Sunday of November. Each time zone in the United States stops using Daylight Saving Time at 2 A.M. local time. So in the United States you would select First, Sunday, November and select 2 in the at field. Daylight Saving Time ends in the European Union on the last Sunday of October. All of the time zones in the European Union stop using Daylight Saving Time at the same moment (1 A.M. GMT or UTC). So in the European Union you would select Last, Sunday, October . The time you select in the at field depends on your time zone. In Germany for instance, you would select 2 because Germany's time zone is one hour ahead of GMT or UTC (GMT+1).
Apply	Click Apply to save your changes back to the NBG6616.
Cancel	Click Cancel to begin configuring this screen afresh.

25.6 Firmware Upgrade Screen

Find firmware at www.zyxel.com in a file that uses the version number and project code with a ***.bin** extension, e.g., "V1.00(AARO.0).bin". The upload process uses HTTP (Hypertext Transfer Protocol) and may take up to two minutes. After a successful upload, the system will reboot.

Click **Maintenance > Firmware Upgrade**. Follow the instructions in this screen to upload firmware to your NBG6616.

Figure 121 Maintenance > Firmware Upgrade

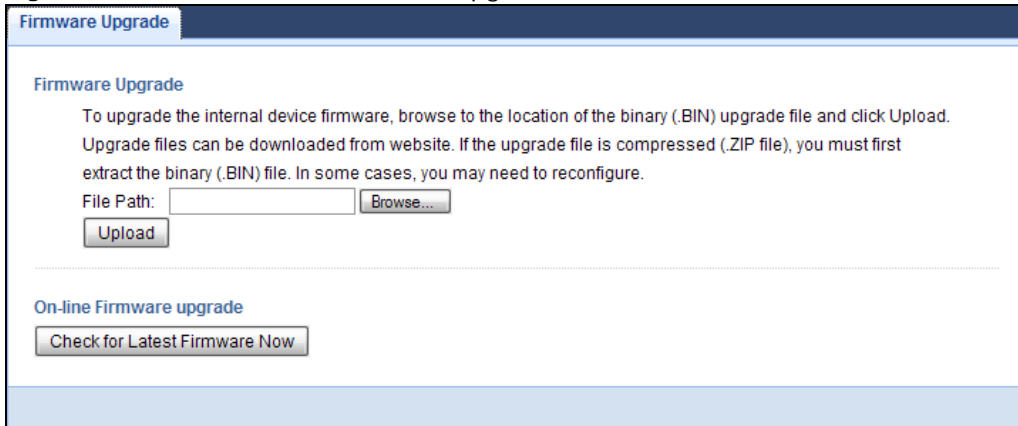

The following table describes the labels in this screen.

Table 79 Maintenance > Firmware Upgrade

LABEL	DESCRIPTION
File Path	Type in the location of the file you want to upload in this field or click Browse... to find it.
Browse...	Click Browse... to find the .bin file you want to upload. Remember that you must decompress compressed (.zip) files before you can upload them.
Upload	Click Upload to begin the upload process. This process may take up to two minutes.
Check for Latest Firmware Now	Click this to check for the latest updated firmware.

Note: Do not turn off the NBG6616 while firmware upload is in progress!

After you see the **Firmware Upload In Process** screen, wait two minutes before logging into the NBG6616 again.

The NBG6616 automatically restarts in this time causing a temporary network disconnect. In some operating systems, you may see the following icon on your desktop.

Figure 122 Network Temporarily Disconnected

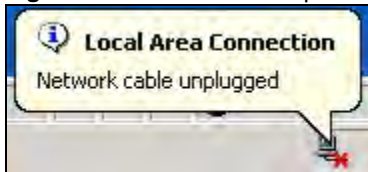

After two minutes, log in again and check your new firmware version in the **Status** screen.

If the upload was not successful, an error message appears. Click **Return** to go back to the **Firmware Upgrade** screen.

25.7 Configuration Backup/Restore Screen

Backup configuration allows you to back up (save) the NBG6616's current configuration to a file on your computer. Once your NBG6616 is configured and functioning properly, it is highly recommended that you back up your configuration file before making configuration changes. The backup configuration file will be useful in case you need to return to your previous settings.

Restore configuration allows you to upload a new or previously saved configuration file from your computer to your NBG6616.

Click **Maintenance > Backup/Restore**. Information related to factory defaults, backup configuration, and restoring configuration appears as shown next.

Figure 123 Maintenance > Backup/Restore

Backup/Restore

Backup Configuration
Click Backup to save the current configuration of your system to your computer.

Restore Configuration
To restore a previously saved configuration file to your system, browse to the location of the configuration file and click Upload.
File Path :

Back to Factory Defaults
Click Reset to clear all user-entered configuration information and return to factory defaults. After resetting, the

- Password will be 1234
- LAN IP address will be 192.168.1.1
- DHCP will be reset to server

The following table describes the labels in this screen.

Table 80 Maintenance > Backup/Restore

LABEL	DESCRIPTION
Backup	Click Backup to save the NBG6616's current configuration to your computer.
File Path	Type in the location of the file you want to upload in this field or click Browse... to find it.
Browse...	Click Browse... to find the file you want to upload. Remember that you must decompress compressed (.ZIP) files before you can upload them.

Table 80 Maintenance > Backup/Restore (continued)

LABEL	DESCRIPTION
Upload	<p>Click Upload to begin the upload process.</p> <p>Note: Do not turn off the NBG6616 while configuration file upload is in progress.</p> <p>After you see a "configuration upload successful" screen, you must then wait one minute before logging into the NBG6616 again. The NBG6616 automatically restarts in this time causing a temporary network disconnect.</p> <p>If you see an error screen, click Back to return to the Backup/Restore screen.</p>
Reset	<p>Pressing the Reset button in this section clears all user-entered configuration information and returns the NBG6616 to its factory defaults.</p> <p>You can also press the RESET button on the rear panel to reset the factory defaults of your NBG6616. Refer to the chapter about introducing the Web Configurator for more information on the RESET button.</p>

Note: If you uploaded the default configuration file you may need to change the IP address of your computer to be in the same subnet as that of the default NBG6616 IP address (192.168.1.1). See [Appendix B on page 200](#) for details on how to set up your computer's IP address.

25.8 Restart Screen

System restart allows you to reboot the NBG6616 without turning the power off.

Click **Maintenance > Restart** to open the following screen.

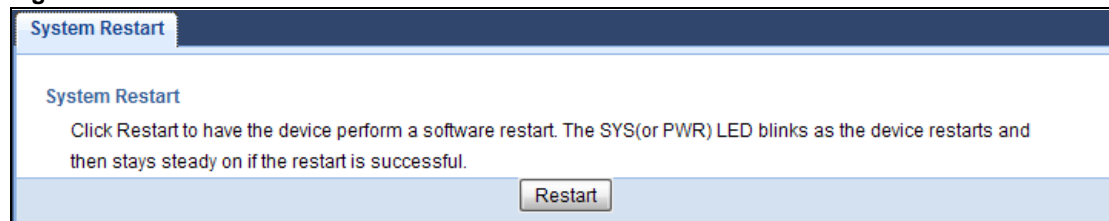
Figure 124 Maintenance > Restart

Click **Restart** to have the NBG6616 reboot. This does not affect the NBG6616's configuration.

25.9 Language Screen

Use this screen to change the language for the Web Configurator.

Select the language you prefer and click **Apply**. The Web Configurator language changes after a while without restarting the NBG6616.

Figure 125 Maintenance > Language

The screenshot shows a web-based configuration interface for the NBG6616. At the top, there is a blue header bar with the word "Language" in white. Below the header, the text "Language selection :" is followed by a dropdown menu currently set to "English". At the bottom right of the interface, there are two buttons: "Apply" and "Cancel".

25.10 System Operation Mode Overview

The **Sys OP Mode** (System Operation Mode) function lets you configure your NBG6616 as a router or access point. You can choose between **Router Mode**, and **Access Point Mode** depending on your network topology and the features you require from your device.

The following describes the device modes available in your NBG6616.

Router

A router connects your local network with another network, such as the Internet. The router has two IP addresses, the LAN IP address and the WAN IP address.

Figure 126 LAN and WAN IP Addresses in Router Mode

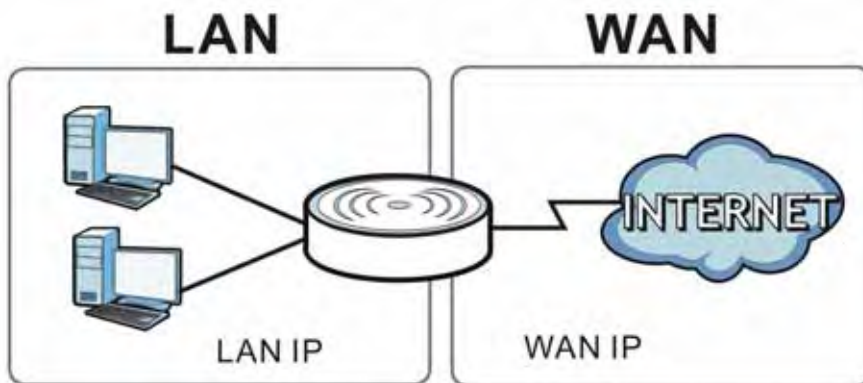

Access Point

An access point enabled all ethernet ports to be bridged together and be in the same subnet. To connect to the Internet, another device, such as a router, is required.

Figure 127 Access Point Mode

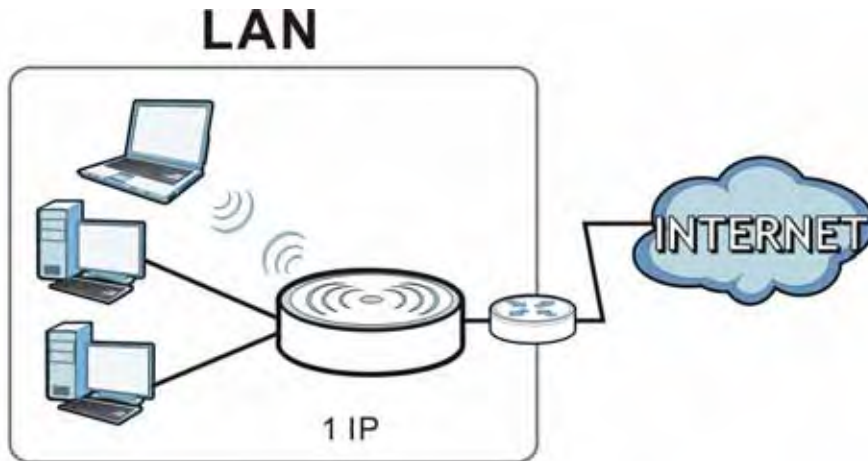

25.11 Sys OP Mode Screen

Use this screen to select how you want to use your NBG6616.

Figure 128 Maintenance > Sys OP Mode

The screenshot shows the "Sys OP Mode" configuration screen. Under "Configuration Mode", there are two radio buttons: "Router Mode" (selected) and "Access Point Mode". Below this is a "Note" section with two paragraphs:

Router: In this mode, the device is supported to connect to internet via ADSL/Cable Modem. PCs in LAN ports share the same IP to ISP through WAN Port.

Access Point: In this mode, all Ethernet ports are bridged together. The device allows the wireless-equipped computer can communicate with a wired network.

At the bottom of the screen are "Apply" and "Cancel" buttons.

The following table describes the labels in the **General** screen.

Table 81 Maintenance > Sys OP Mode

LABEL	DESCRIPTION
Configuration Mode	
Router Mode	Select Router Mode if your device routes traffic between a local network and another network such as the Internet. This mode offers services such as a firewall or bandwidth management. You can configure the IP address settings on your WAN port. Contact your ISP or system administrator for more information on appropriate settings.

Table 81 Maintenance > Sys OP Mode (continued)

LABEL	DESCRIPTION
Access Point Mode	Select Access Point Mode if your device bridges traffic between clients on the same network. <ul style="list-style-type: none">• In Access Point Mode, all Ethernet ports have the same IP address.• All ports on the rear panel of the device are LAN ports, including the port labeled WAN. There is no WAN port.• The DHCP server on your device is disabled.• Router functions (such as NAT, bandwidth management, remote management, firewall and so on) are not available when the NBG6616 is in Access Point Mode.• The IP address of the device on the local network is set to 192.168.1.2.
Apply	Click Apply to save your settings.
Cancel	Click Cancel to return your settings to the default (Router).

Note: If you select the incorrect system operation Mode you may not be able to connect to the Internet.

Troubleshooting

26.1 Overview

This chapter offers some suggestions to solve problems you might encounter. The potential problems are divided into the following categories.

- [Power, Hardware Connections, and LEDs](#)
- [NBG6616 Access and Login](#)
- [Internet Access](#)
- [Resetting the NBG6616 to Its Factory Defaults](#)
- [Wireless Connections](#)
- [USB Device Problems](#)

26.2 Power, Hardware Connections, and LEDs

The NBG6616 does not turn on. None of the LEDs turn on.

- 1 Make sure you are using the power adaptor or cord included with the NBG6616.
- 2 Make sure the power adaptor or cord is connected to the NBG6616 and plugged in to an appropriate power source. Make sure the power source is turned on.
- 3 Disconnect and re-connect the power adaptor or cord to the NBG6616.
- 4 If the problem continues, contact the vendor.

One of the LEDs does not behave as expected.

- 1 Make sure you understand the normal behavior of the LED. See [Section 1.7 on page 14](#).
- 2 Check the hardware connections. See the Quick Start Guide.
- 3 Inspect your cables for damage. Contact the vendor to replace any damaged cables.
- 4 Disconnect and re-connect the power adaptor to the NBG6616.

- 5 If the problem continues, contact the vendor.

26.3 NBG6616 Access and Login

I don't know the IP address of my NBG6616.

- 1 The default IP address of the NBG6616 in **Router Mode** is **192.168.1.1**. The default IP address of the NBG6616 in **Access Point Mode** is **192.168.1.2**.
- 2 If you changed the IP address and have forgotten it, you might get the IP address of the NBG6616 in **Router Mode** by looking up the IP address of the default gateway for your computer. To do this in most Windows computers, click **Start > Run**, enter **cmd**, and then enter **ipconfig**. The IP address of the **Default Gateway** might be the IP address of the NBG6616 (it depends on the network), so enter this IP address in your Internet browser.
- 3 If your NBG6616 in **Access Point Mode** is a DHCP client, you can find your IP address from the DHCP server. This information is only available from the DHCP server which allocates IP addresses on your network. Find this information directly from the DHCP server or contact your system administrator for more information.
- 4 Reset your NBG6616 to change all settings back to their default. This means your current settings are lost. See [Section 26.5 on page 188](#) in the **Troubleshooting** for information on resetting your NBG6616.

I forgot the password.

- 1 The default password is **1234**.
- 2 If this does not work, you have to reset the device to its factory defaults. See [Section 26.5 on page 188](#).

I cannot see or access the **Login** screen in the Web Configurator.

- 1 Make sure you are using the correct IP address.
 - The default IP address of the NBG6616 in **Router Mode** is **192.168.1.1**. The default IP address of the NBG6616 in **Access Point Mode** is **192.168.1.2**.
 - If you changed the IP address ([Section 12.4 on page 108](#)), use the new IP address.
 - If you changed the IP address and have forgotten it, see the troubleshooting suggestions for [I don't know the IP address of my NBG6616](#).

- 2 Check the hardware connections, and make sure the LEDs are behaving as expected. See the Quick Start Guide.
- 3 Make sure your Internet browser does not block pop-up windows and has JavaScript and Java enabled. See [Appendix A on page 191](#).
- 4 Make sure your computer is in the same subnet as the NBG6616. (If you know that there are routers between your computer and the NBG6616, skip this step.)
 - If there is a DHCP server on your network, make sure your computer is using a dynamic IP address. See [Section 12.4 on page 108](#).
 - If there is no DHCP server on your network, make sure your computer's IP address is in the same subnet as the NBG6616. See [Section 12.4 on page 108](#).
- 5 Reset the device to its factory defaults, and try to access the NBG6616 with the default IP address. See [Section 1.5 on page 13](#).
- 6 If the problem continues, contact the network administrator or vendor, or try one of the advanced suggestions.

Advanced Suggestions

- Try to access the NBG6616 using another service, such as Telnet. If you can access the NBG6616, check the remote management settings and firewall rules to find out why the NBG6616 does not respond to HTTP.
- If your computer is connected to the **WAN** port or is connected wirelessly, use a computer that is connected to a **LAN/ETHERNET** port.

I can see the **Login** screen, but I cannot log in to the NBG6616.

- 1 Make sure you have entered the password correctly. The default password is **1234**. This field is case-sensitive, so make sure [Caps Lock] is not on.
- 2 This can happen when you fail to log out properly from your last session. Try logging in again after 5 minutes.
- 3 Disconnect and re-connect the power adaptor or cord to the NBG6616.
- 4 If this does not work, you have to reset the device to its factory defaults. See [Section 26.5 on page 188](#).

26.4 Internet Access

I cannot access the Internet.

- 1 Check the hardware connections, and make sure the LEDs are behaving as expected. See the Quick Start Guide.
- 2 Go to **Maintenance > Sys OP Mode**. Check your System Operation Mode setting.
 - If the NBG6616 is in **Router Mode**, make sure the WAN port is connected to a broadband modem or router with Internet access. Your computer and the NBG6616 should be in the same subnet.
 - If the NBG6616 is in **Access Point Mode**, make sure the WAN port is connected to a broadband modem or router with Internet access and your computer is set to obtain an dynamic IP address.
- 3 If the NBG6616 is in **Router Mode**, make sure you entered your ISP account information correctly in the wizard or the WAN screen. These fields are case-sensitive, so make sure [Caps Lock] is not on.
- 4 If you are trying to access the Internet wirelessly, make sure the wireless settings in the wireless client are the same as the settings in the AP.
- 5 Disconnect all the cables from your device, and follow the directions in the Quick Start Guide again.
- 6 If the problem continues, contact your ISP.

I cannot access the Internet anymore. I had access to the Internet (with the NBG6616), but my Internet connection is not available anymore.

- 1 Check the hardware connections, and make sure the LEDs are behaving as expected. See the Quick Start Guide and [Section 1.7 on page 14](#).
- 2 Reboot the NBG6616.
- 3 If the problem continues, contact your ISP.

The Internet connection is slow or intermittent.

- 1 There might be a lot of traffic on the network. Look at the LEDs, and check [Section 1.7 on page 14](#). If the NBG6616 is sending or receiving a lot of information, try closing some programs that use the Internet, especially peer-to-peer applications.
- 2 Check the signal strength. If the signal strength is low, try moving the NBG6616 closer to the AP if possible, and look around to see if there are any devices that might be interfering with the wireless network (for example, microwaves, other wireless networks, and so on).
- 3 Reboot the NBG6616.
- 4 If the problem continues, contact the network administrator or vendor, or try one of the advanced suggestions.

Advanced Suggestion

- Check the settings for QoS. If it is disabled, you might consider activating it.

26.5 Resetting the NBG6616 to Its Factory Defaults

If you reset the NBG6616, you lose all of the changes you have made. The NBG6616 re-loads its default settings, and the password resets to **1234**. You have to make all of your changes again.

You will lose all of your changes when you push the **RESET** button.

To reset the NBG6616:

- 1 Make sure the power LED is on.
- 2 Press the **RESET** button for one to four seconds to restart/reboot the NBG6616.
- 3 Press the **RESET** button for longer than five seconds to set the NBG6616 back to its factory-default configurations.

If the NBG6616 restarts automatically, wait for the NBG6616 to finish restarting, and log in to the Web Configurator. The password is "1234".

If the NBG6616 does not restart automatically, disconnect and reconnect the NBG6616's power. Then, follow the directions above again.

26.6 Wireless Connections

I cannot access the NBG6616 or ping any computer from the WLAN.

- 1 Make sure the wireless LAN is enabled on the NBG6616.
- 2 Make sure the wireless adapter on your computer is working properly.
- 3 Make sure the wireless adapter installed on your computer is IEEE 802.11 compatible and supports the same wireless standard as the NBG6616.
- 4 Make sure your computer (with a wireless adapter installed) is within the transmission range of the NBG6616.
- 5 Check that both the NBG6616 and the wireless adapter on your computer are using the same wireless and wireless security settings.
- 6 Make sure traffic between the WLAN and the LAN is not blocked by the firewall on the NBG6616.

- 7 Make sure you allow the NBG6616 to be remotely accessed through the WLAN interface. Check your remote management settings.
 - See the chapter on [Wireless LAN](#) in the User's Guide for more information.

I set up URL keyword blocking, but I can still access a website that should be blocked.

Make sure that you enable parental control in the **Parental Control** screen, set up rules and turn on the rules. Make sure that the keywords that you type are listed in the rule's **Keyword List**.

If a keyword that is listed in the **Keyword List** is not blocked when it is found in a URL, customize the keyword blocking using commands. See the [Customizing Keyword Blocking URL Checking](#) section in the [Parental Control](#) chapter.

I cannot access the Web Configurator after I switched to AP mode.

When you change from router mode to AP mode, your computer must have an IP address in the range between "192.168.1.3" and "192.168.1.254".

Refer to [Appendix B on page 200](#) for instructions on how to change your computer's IP address.

What factors may cause intermittent or unstabled wireless connection? How can I solve this problem?

The following factors may cause interference:

- Obstacles: walls, ceilings, furniture, and so on.
- Building Materials: metal doors, aluminum studs.
- Electrical devices: microwaves, monitors, electric motors, cordless phones, and other wireless devices.

To optimize the speed and quality of your wireless connection, you can:

- Move your wireless device closer to the AP if the signal strength is low.
- Reduce wireless interference that may be caused by other wireless networks or surrounding wireless electronics such as cordless phones.
- Place the AP where there are minimum obstacles (such as walls and ceilings) between the AP and the wireless client.
- Reduce the number of wireless clients connecting to the same AP simultaneously, or add additional APs if necessary.
- Try closing some programs that use the Internet, especially peer-to-peer applications. If the wireless client is sending or receiving a lot of information, it may have too many programs open that use the Internet.

- Position the antennas for best reception. If the AP is placed on a table or floor, point the antennas upwards. If the AP is placed at a high position, point the antennas downwards. Try pointing the antennas in different directions and check which provides the strongest signal to the wireless clients.

26.7 USB Device Problems

I cannot access or see a USB device that is connected to the NBG6616.

- 1 Disconnect the problematic USB device, then reconnect it to the NBG6616.
- 2 Ensure that the USB device has power.
- 3 Check your cable connections.
- 4 Restart the NBG6616 by disconnecting the power and then reconnecting it.
- 5 If the USB device requires a special driver, install the driver from the installation disc that came with the device. After driver installation, reconnect the USB device to the NBG6616 and try to connect to it again with your computer.
- 6 If the problem persists, contact your vendor.

What kind of USB devices do the NBG6616 support?

- 1 It is strongly recommended to use version 2.0 or lower USB storage devices (such as memory sticks, USB hard drives) and/or USB devices. Other USB products are not guaranteed to function properly with the NBG6616.

Pop-up Windows, JavaScript and Java Permissions

In order to use the web configurator you need to allow:

- Web browser pop-up windows from your device.
- JavaScript (enabled by default).
- Java permissions (enabled by default).

Note: The screens used below belong to Internet Explorer version 6, 7 and 8. Screens for other Internet Explorer versions may vary.

Internet Explorer Pop-up Blockers

You may have to disable pop-up blocking to log into your device.

Either disable pop-up blocking (enabled by default in Windows XP SP (Service Pack) 2) or allow pop-up blocking and create an exception for your device's IP address.

Disable Pop-up Blockers

- 1 In Internet Explorer, select **Tools, Pop-up Blocker** and then select **Turn Off Pop-up Blocker**.

Figure 129 Pop-up Blocker

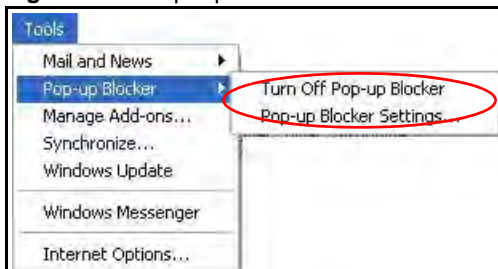

You can also check if pop-up blocking is disabled in the **Pop-up Blocker** section in the **Privacy** tab.

- 1 In Internet Explorer, select **Tools, Internet Options, Privacy**.
- 2 Clear the **Block pop-ups** check box in the **Pop-up Blocker** section of the screen. This disables any web pop-up blockers you may have enabled.

Figure 130 Internet Options: Privacy

- 3 Click **Apply** to save this setting.

Enable Pop-up Blockers with Exceptions

Alternatively, if you only want to allow pop-up windows from your device, see the following steps.

- 1 In Internet Explorer, select **Tools, Internet Options** and then the **Privacy** tab.
- 2 Select **Settings...** to open the **Pop-up Blocker Settings** screen.

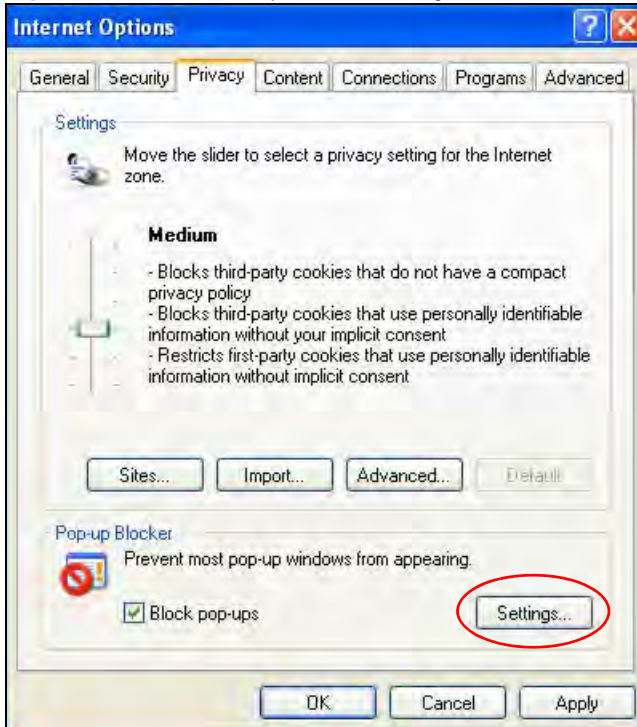
Figure 131 Internet Options: Privacy

- 3 Type the IP address of your device (the web page that you do not want to have blocked) with the prefix "http://". For example, http://192.168.167.1.
- 4 Click **Add** to move the IP address to the list of **Allowed sites**.

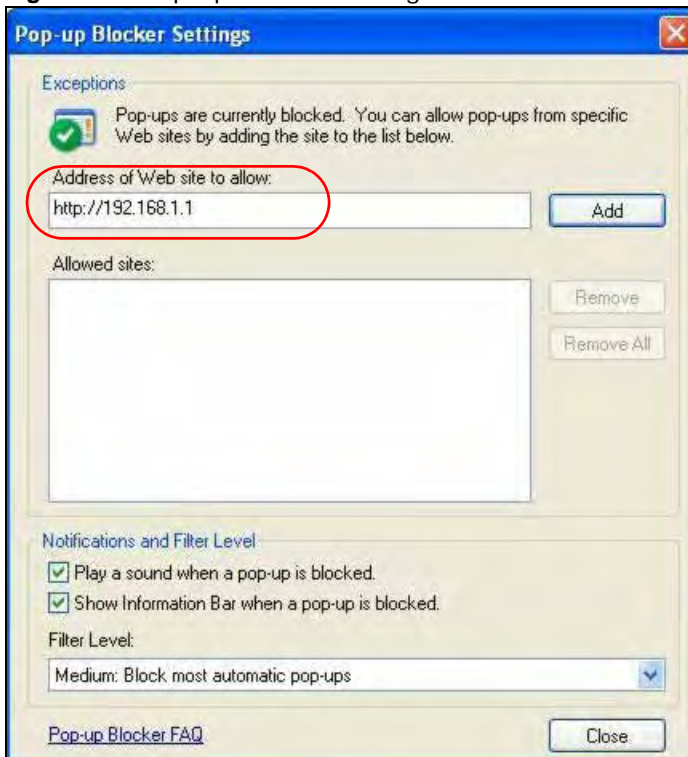
Figure 132 Pop-up Blocker Settings

- 5 Click **Close** to return to the **Privacy** screen.
- 6 Click **Apply** to save this setting.

JavaScript

If pages of the web configurator do not display properly in Internet Explorer, check that JavaScript are allowed.

- 1 In Internet Explorer, click **Tools**, **Internet Options** and then the **Security** tab.

Figure 133 Internet Options: Security

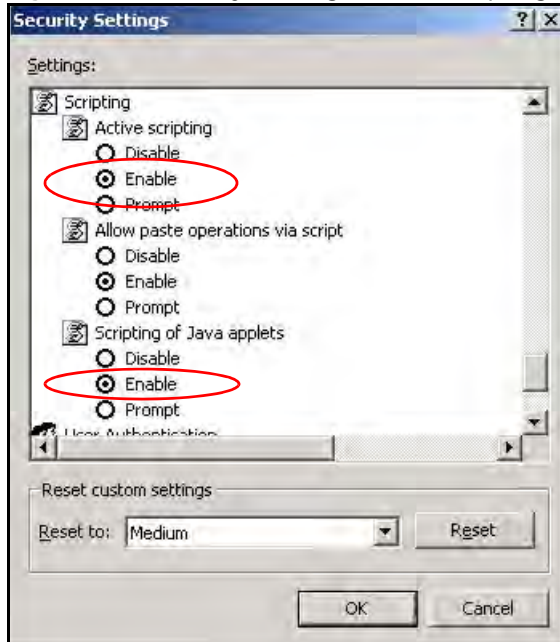

- 2 Click the **Custom Level...** button.
- 3 Scroll down to **Scripting**.
- 4 Under **Active scripting** make sure that **Enable** is selected (the default).
- 5 Under **Scripting of Java applets** make sure that **Enable** is selected (the default).
- 6 Click **OK** to close the window.

Figure 134 Security Settings - Java Scripting

Java Permissions

- 1 From Internet Explorer, click **Tools**, **Internet Options** and then the **Security** tab.
- 2 Click the **Custom Level...** button.
- 3 Scroll down to **Microsoft VM**.
- 4 Under **Java permissions** make sure that a safety level is selected.
- 5 Click **OK** to close the window.

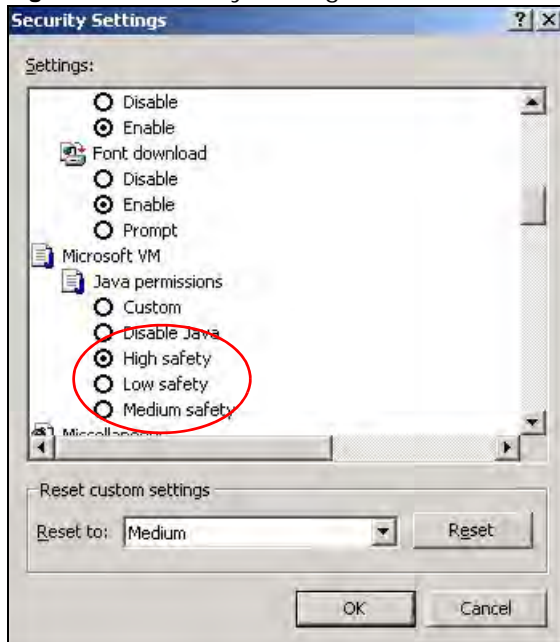
Figure 135 Security Settings - Java

JAVA (Sun)

- 1 From Internet Explorer, click **Tools, Internet Options** and then the **Advanced** tab.
- 2 Make sure that **Use Java 2 for <applet>** under **Java (Sun)** is selected.
- 3 Click **OK** to close the window.

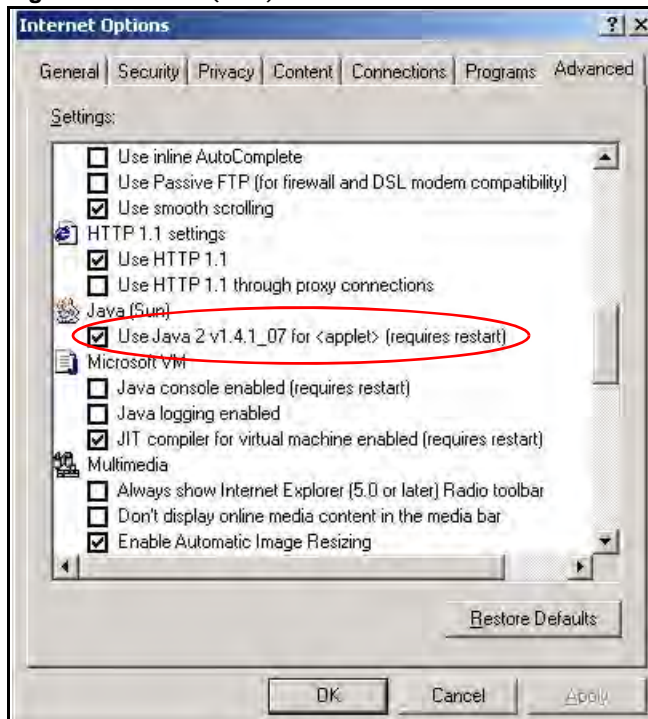
Figure 136 Java (Sun)

Mozilla Firefox

Mozilla Firefox 2.0 screens are used here. Screens for other versions may vary slightly. The steps below apply to Mozilla Firefox 3.0 as well.

You can enable Java, Javascript and pop-ups in one screen. Click **Tools**, then click **Options** in the screen that appears.

Figure 137 Mozilla Firefox: TOOLS > Options

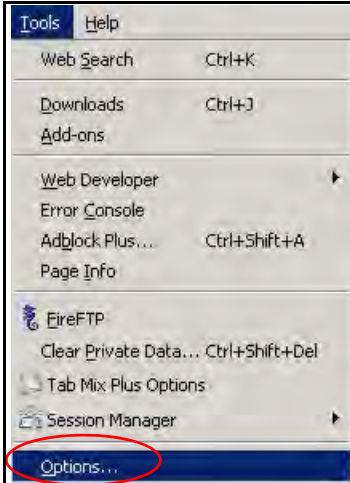

Click **Content** to show the screen below. Select the check boxes as shown in the following screen.

Figure 138 Mozilla Firefox Content Security

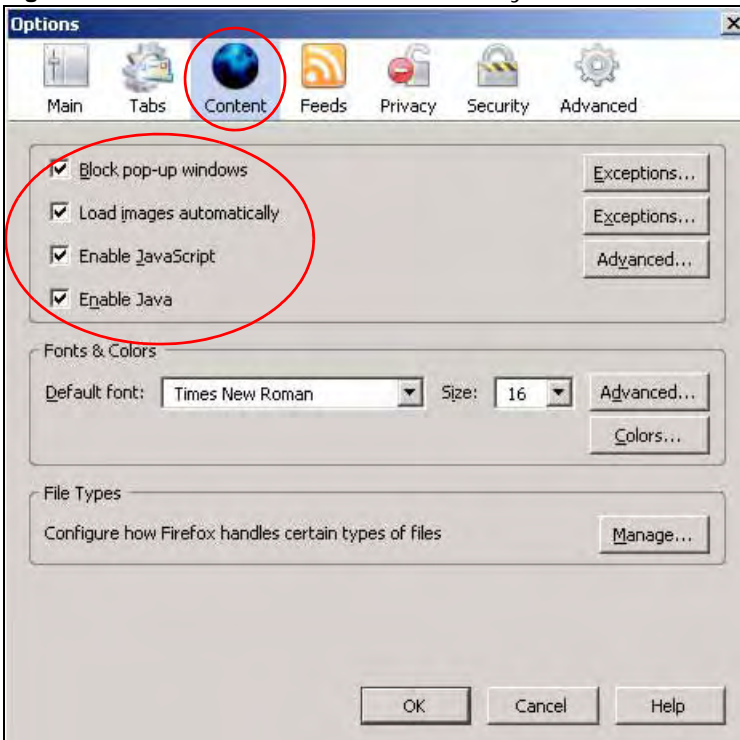

Opera

Opera 10 screens are used here. Screens for other versions may vary slightly.

Allowing Pop-Ups

From Opera, click **Tools**, then **Preferences**. In the **General** tab, go to **Choose how you prefer to handle pop-ups** and select **Open all pop-ups**.

Figure 139 Opera: Allowing Pop-Ups

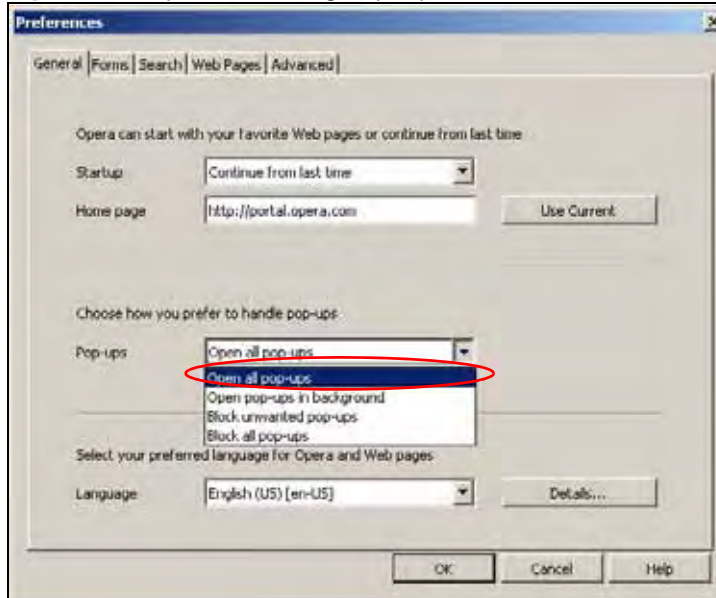

Enabling Java

From Opera, click **Tools**, then **Preferences**. In the **Advanced** tab, select **Content** from the left-side menu. Select the check boxes as shown in the following screen.

Figure 140 Opera: Enabling Java

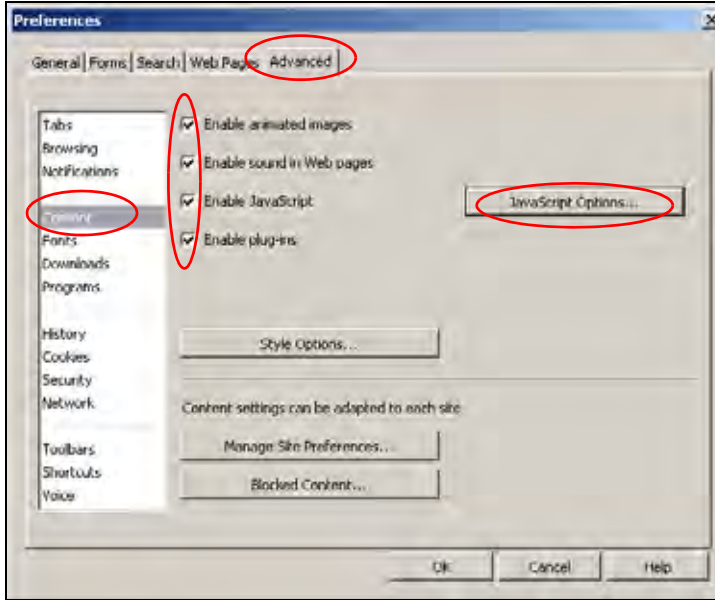

To customize JavaScript behavior in the Opera browser, click **JavaScript Options**.

Figure 141 Opera: JavaScript Options

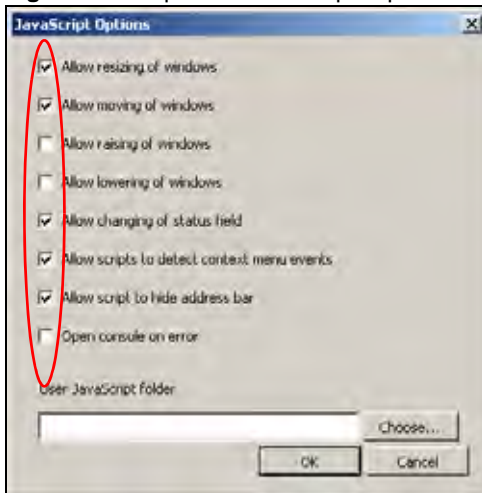

Select the items you want Opera's JavaScript to apply.

Setting Up Your Computer's IP Address

Note: Your specific NBG6616 may not support all of the operating systems described in this appendix. See the product specifications for more information about which operating systems are supported.

This appendix shows you how to configure the IP settings on your computer in order for it to be able to communicate with the other devices on your network. Windows Vista/XP/2000, Mac OS 9/OS X, and all versions of UNIX/LINUX include the software components you need to use TCP/IP on your computer.

If you manually assign IP information instead of using a dynamic IP, make sure that your network's computers have IP addresses that place them in the same subnet.

In this appendix, you can set up an IP address for:

- [Windows XP/NT/2000](#) on [page 200](#)
- [Windows Vista](#) on [page 204](#)
- [Windows 7](#) on [page 208](#)
- [Mac OS X: 10.3 and 10.4](#) on [page 212](#)
- [Mac OS X: 10.5 and 10.6](#) on [page 215](#)
- [Linux: Ubuntu 8 \(GNOME\)](#) on [page 218](#)
- [Linux: openSUSE 10.3 \(KDE\)](#) on [page 222](#)

Windows XP/NT/2000

The following example uses the default Windows XP display theme but can also apply to Windows 2000 and Windows NT.

- 1 Click **Start** > **Control Panel**.

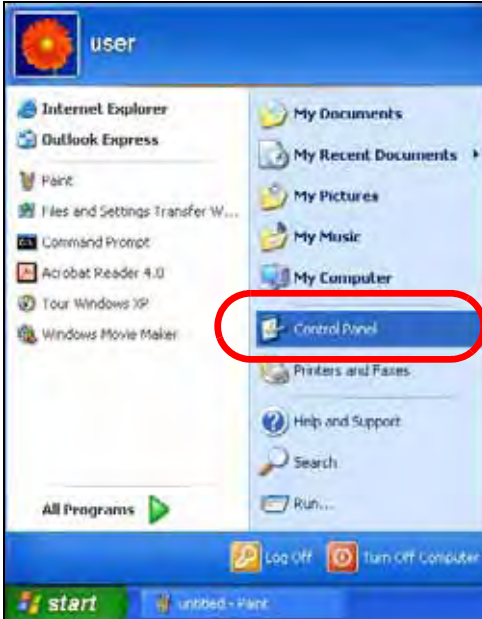

- 2 In the **Control Panel**, click the **Network Connections** icon.



- 3 Right-click **Local Area Connection** and then select **Properties**.

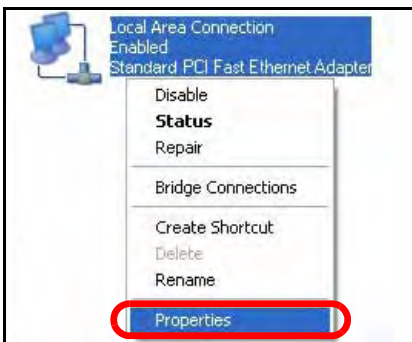

- 4 On the **General** tab, select **Internet Protocol (TCP/IP)** and then click **Properties**.

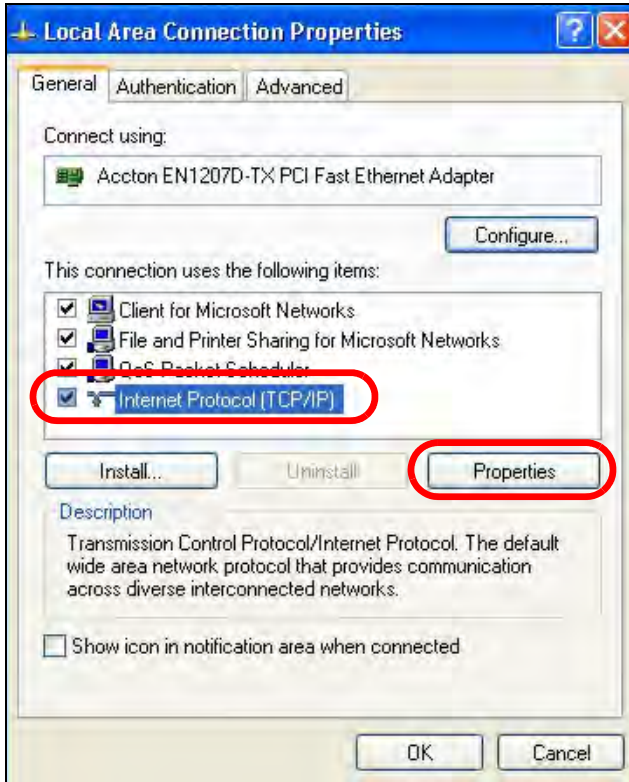

- 5 The **Internet Protocol TCP/IP Properties** window opens.

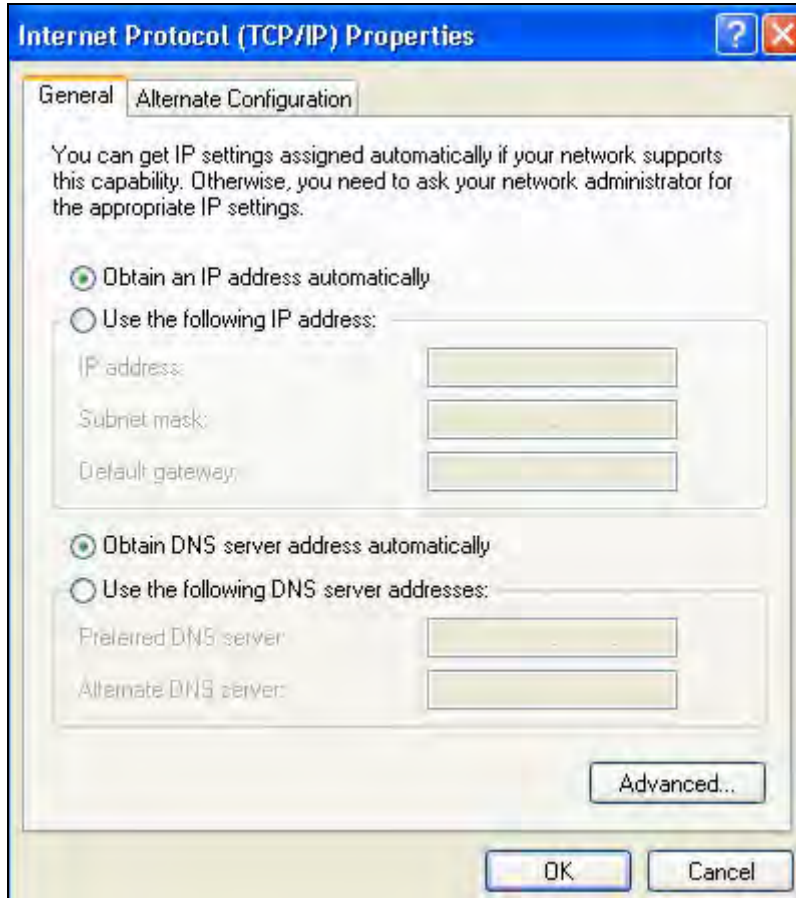

- 6 Select **Obtain an IP address automatically** if your network administrator or ISP assigns your IP address dynamically.

Select **Use the following IP Address** and fill in the **IP address**, **Subnet mask**, and **Default gateway** fields if you have a static IP address that was assigned to you by your network administrator or ISP. You may also have to enter a **Preferred DNS server** and an **Alternate DNS server**, if that information was provided.

- 7 Click **OK** to close the **Internet Protocol (TCP/IP) Properties** window.
- 8 Click **OK** to close the **Local Area Connection Properties** window.

Verifying Settings

- 1 Click **Start > All Programs > Accessories > Command Prompt**.
- 2 In the **Command Prompt** window, type "ipconfig" and then press [ENTER].

You can also go to **Start > Control Panel > Network Connections**, right-click a network connection, click **Status** and then click the **Support** tab to view your IP address and connection information.

Windows Vista

This section shows screens from Windows Vista Professional.

- 1 Click **Start > Control Panel**.

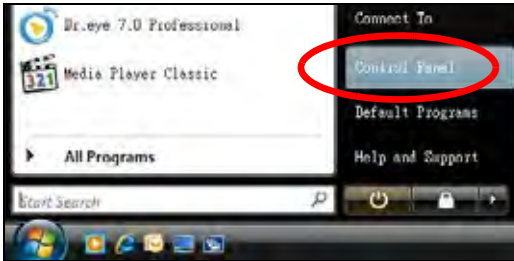

- 2 In the **Control Panel**, click the **Network and Internet** icon.

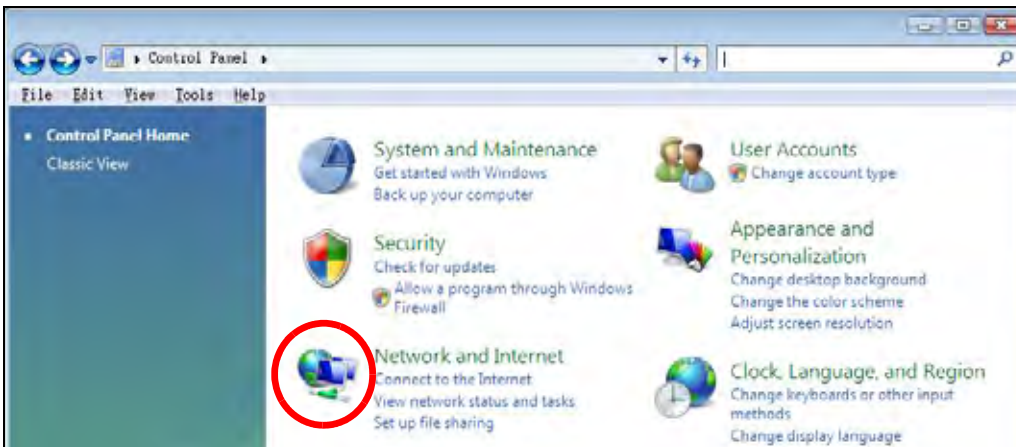

- 3 Click the **Network and Sharing Center** icon.



- 4 Click **Manage network connections**.

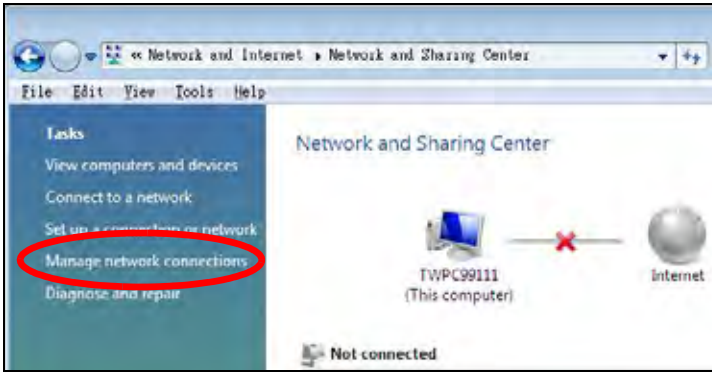

- 5 Right-click **Local Area Connection** and then select **Properties**.

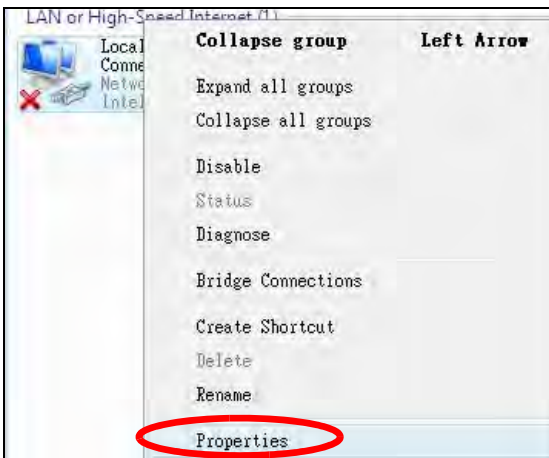

Note: During this procedure, click **Continue** whenever Windows displays a screen saying that it needs your permission to continue.

- 6 Select **Internet Protocol Version 4 (TCP/IPv4)** and then select **Properties**.

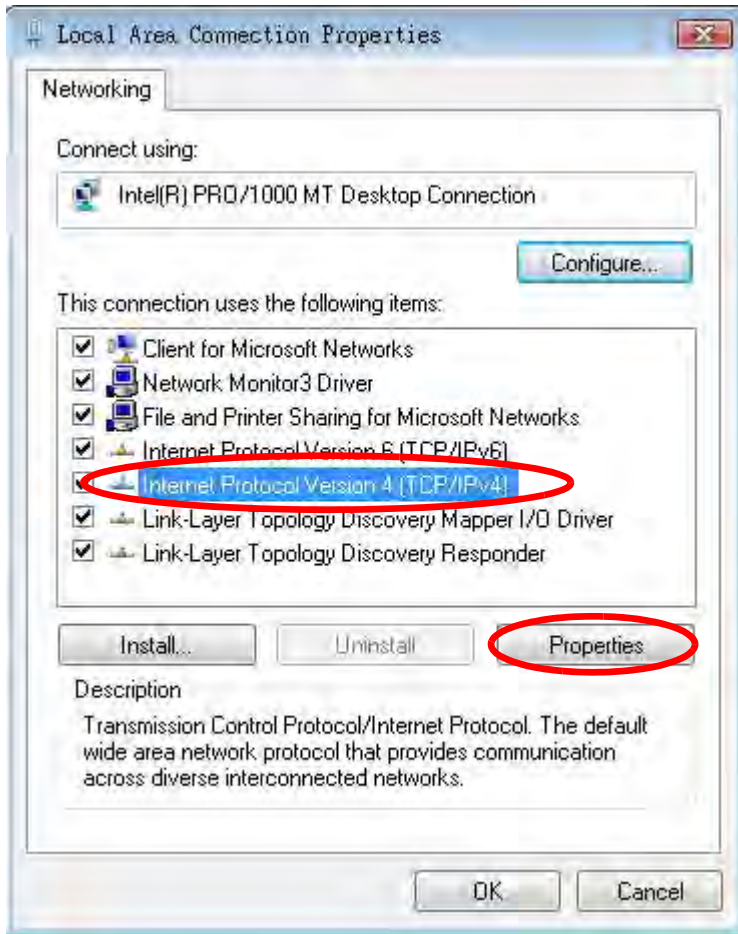

- 7 The **Internet Protocol Version 4 (TCP/IPv4) Properties** window opens.

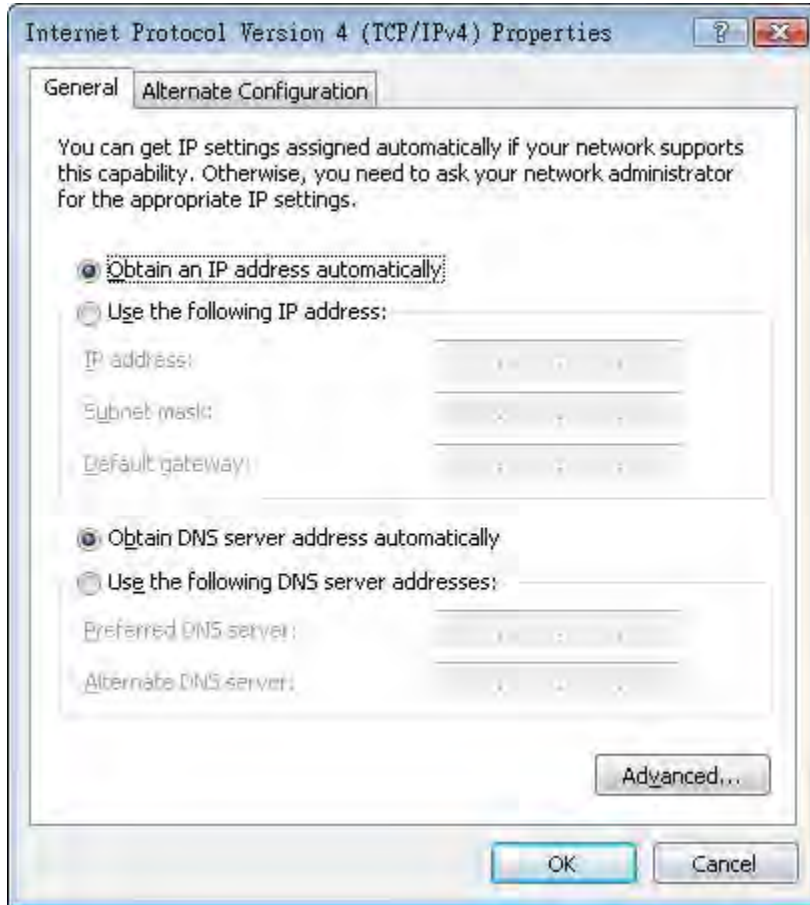

- 8 Select **Obtain an IP address automatically** if your network administrator or ISP assigns your IP address dynamically.
Select **Use the following IP Address** and fill in the **IP address**, **Subnet mask**, and **Default gateway** fields if you have a static IP address that was assigned to you by your network administrator or ISP. You may also have to enter a **Preferred DNS server** and an **Alternate DNS server**, if that information was provided. Click **Advanced**.
- 9 Click **OK** to close the **Internet Protocol (TCP/IP) Properties** window.
- 10 Click **OK** to close the **Local Area Connection Properties** window.

Verifying Settings

- 1 Click **Start > All Programs > Accessories > Command Prompt**.
- 2 In the **Command Prompt** window, type "ipconfig" and then press [ENTER].
You can also go to **Start > Control Panel > Network Connections**, right-click a network connection, click **Status** and then click the **Support** tab to view your IP address and connection information.

Windows 7

This section shows screens from Windows 7 Enterprise.

- 1 Click **Start > Control Panel**.

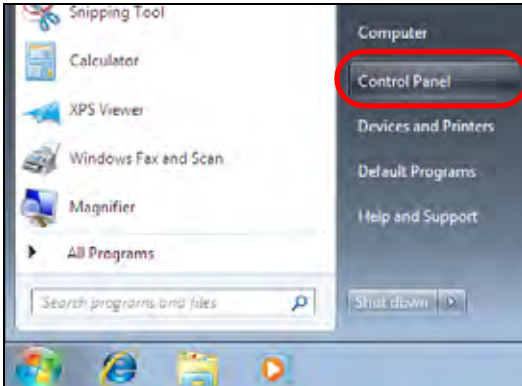

- 2 In the **Control Panel**, click **View network status and tasks** under the **Network and Internet** category.

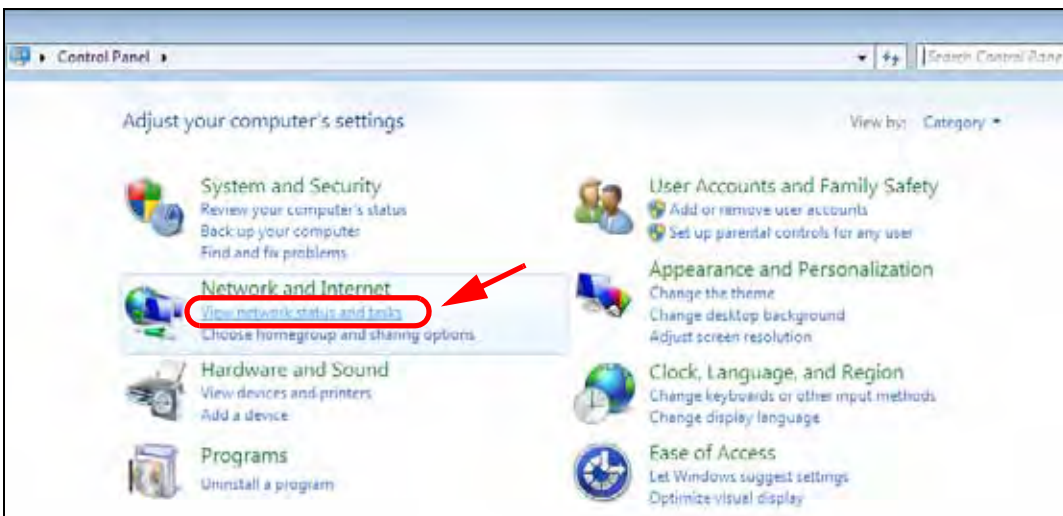

- 3 Click **Change adapter settings**.

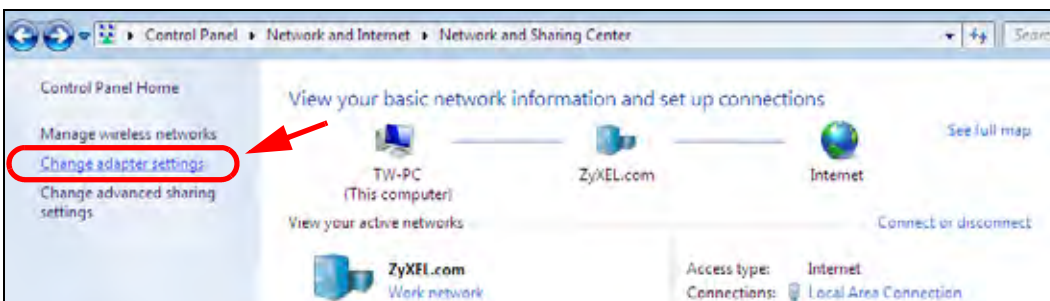

- 4 Double click **Local Area Connection** and then select **Properties**.

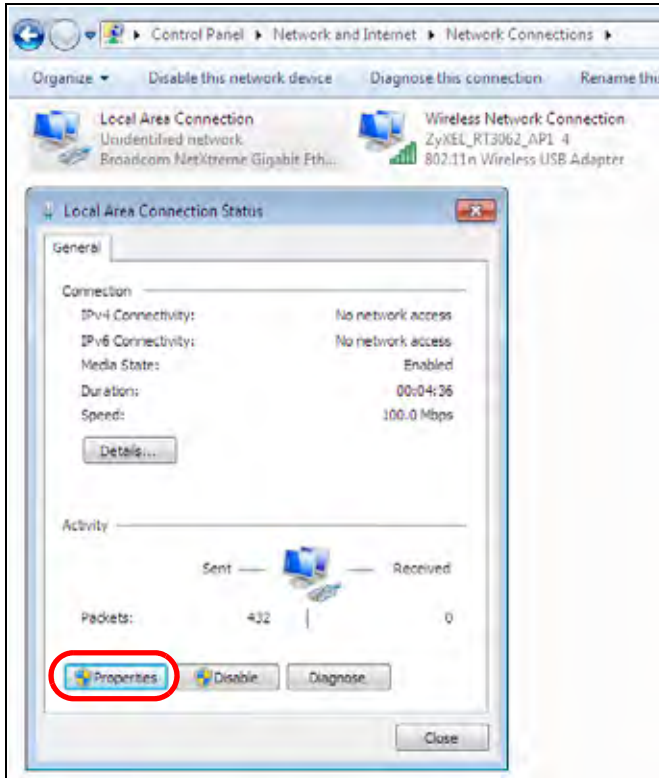

Note: During this procedure, click **Continue** whenever Windows displays a screen saying that it needs your permission to continue.

- 5 Select **Internet Protocol Version 4 (TCP/IPv4)** and then select **Properties**.

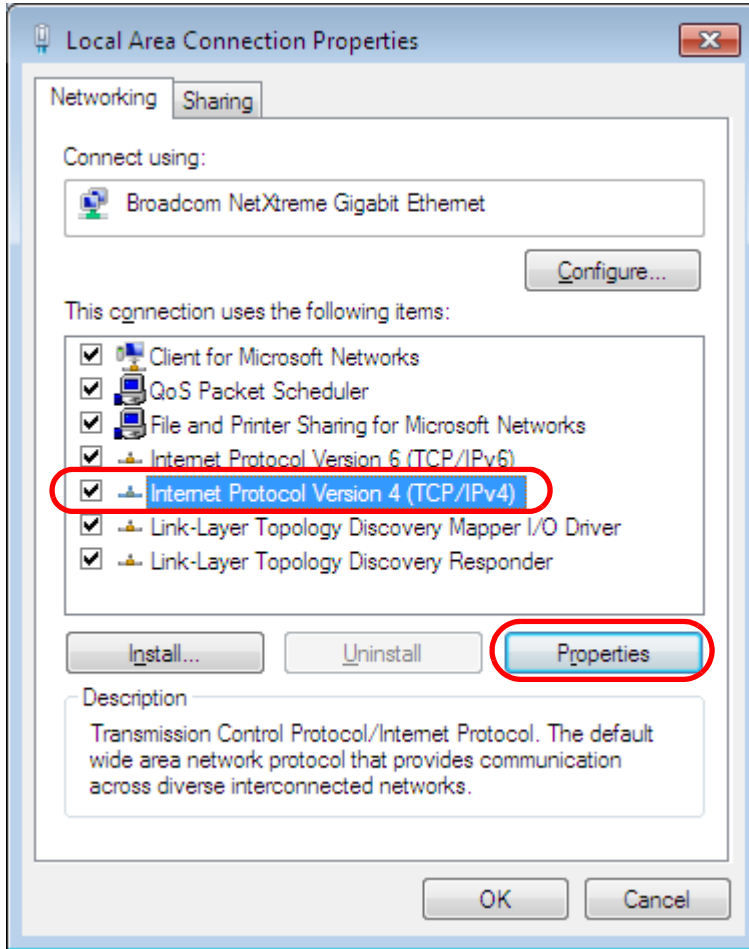

- 6 The **Internet Protocol Version 4 (TCP/IPv4) Properties** window opens.

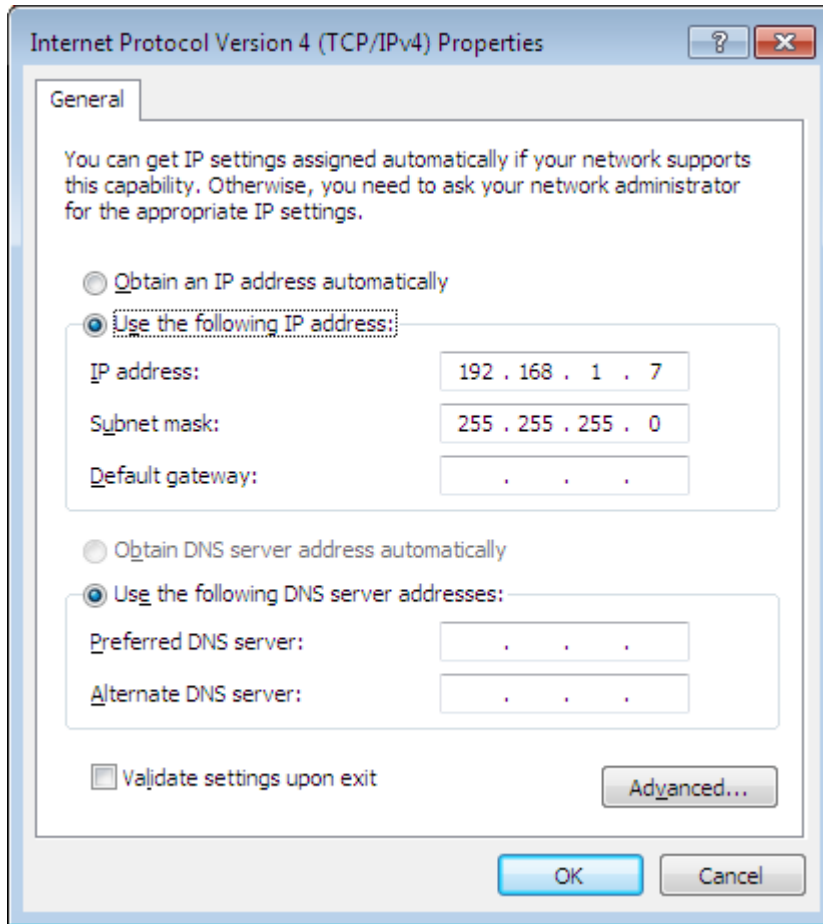

- 7 Select **Obtain an IP address automatically** if your network administrator or ISP assigns your IP address dynamically.

Select **Use the following IP Address** and fill in the **IP address**, **Subnet mask**, and **Default gateway** fields if you have a static IP address that was assigned to you by your network administrator or ISP. You may also have to enter a **Preferred DNS server** and an **Alternate DNS server**, if that information was provided. Click **Advanced** if you want to configure advanced settings for IP, DNS and WINS.

- 8 Click **OK** to close the **Internet Protocol (TCP/IP) Properties** window.
- 9 Click **OK** to close the **Local Area Connection Properties** window.

Verifying Settings

- 1 Click **Start > All Programs > Accessories > Command Prompt**.
- 2 In the **Command Prompt** window, type "ipconfig" and then press [ENTER].
- 3 The IP settings are displayed as follows.

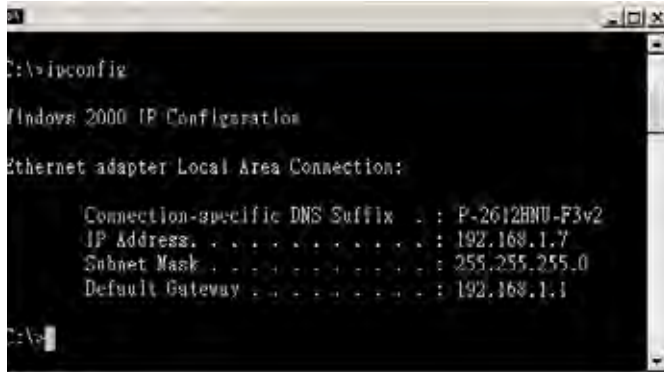

Mac OS X: 10.3 and 10.4

The screens in this section are from Mac OS X 10.4 but can also apply to 10.3.

- 1 Click **Apple** > **System Preferences**.



- 2 In the **System Preferences** window, click the **Network** icon.



- 3 When the **Network** preferences pane opens, select **Built-in Ethernet** from the network connection type list, and then click **Configure**.

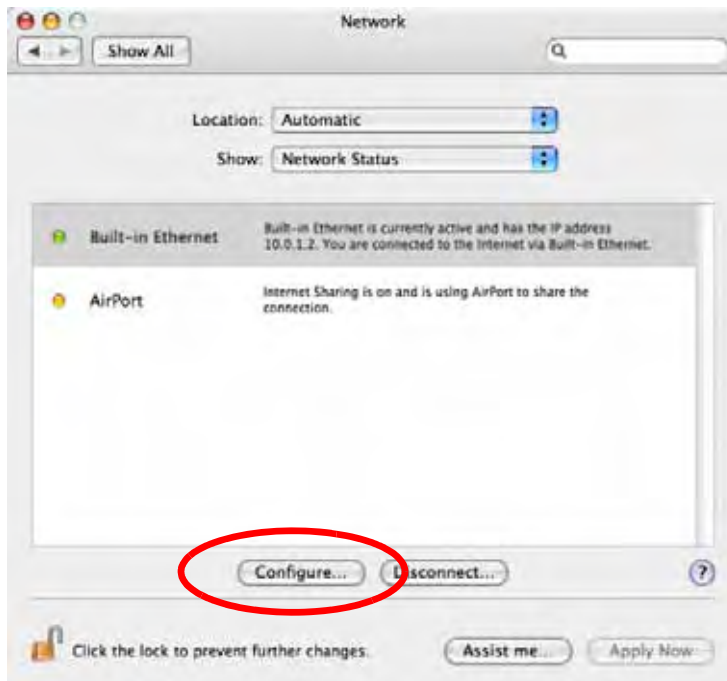

- 4 For dynamically assigned settings, select **Using DHCP** from the **Configure IPv4** list in the **TCP/IP** tab.

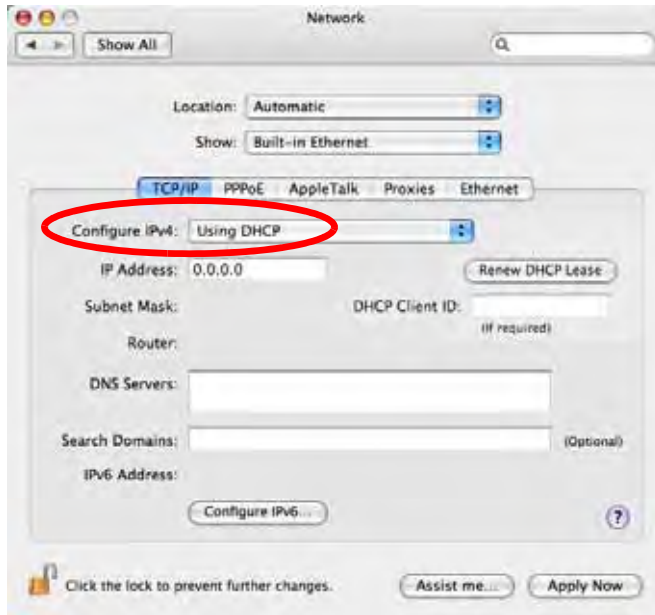

- 5 For statically assigned settings, do the following:
 - From the **Configure IPv4** list, select **Manually**.
 - In the **IP Address** field, type your IP address.
 - In the **Subnet Mask** field, type your subnet mask.
 - In the **Router** field, type the IP address of your device.

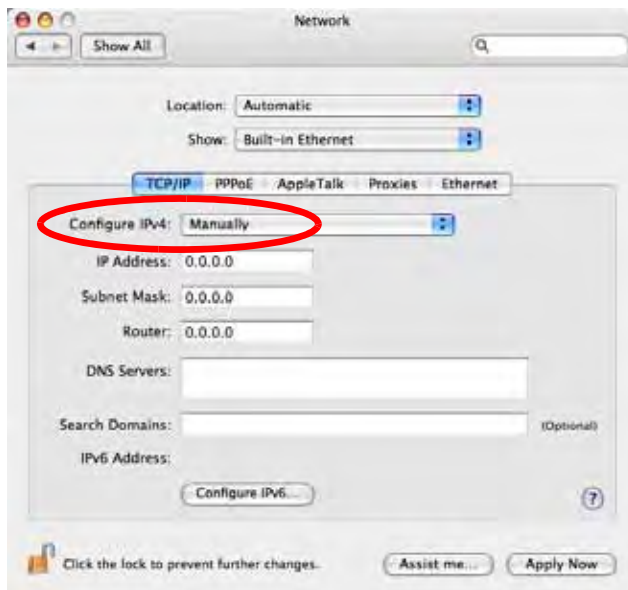

- 6 Click **Apply Now** and close the window.

Verifying Settings

Check your TCP/IP properties by clicking **Applications > Utilities > Network Utilities**, and then selecting the appropriate **Network Interface** from the **Info** tab.

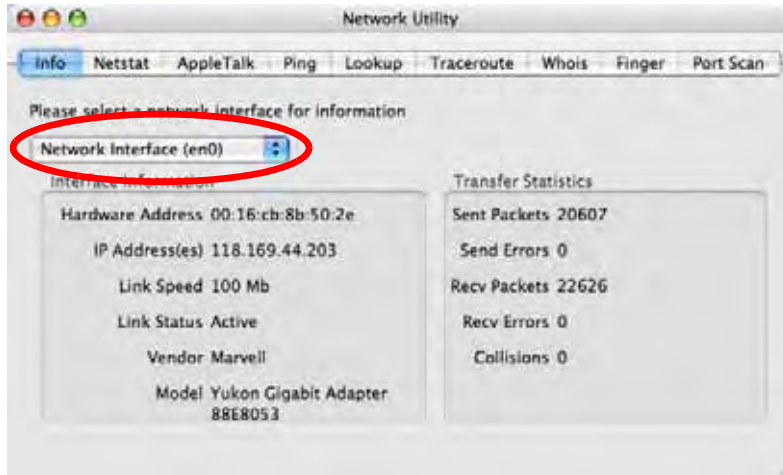
Figure 142 Mac OS X 10.4: Network Utility

Mac OS X: 10.5 and 10.6

The screens in this section are from Mac OS X 10.5 but can also apply to 10.6.

- 1 Click **Apple** > **System Preferences**.

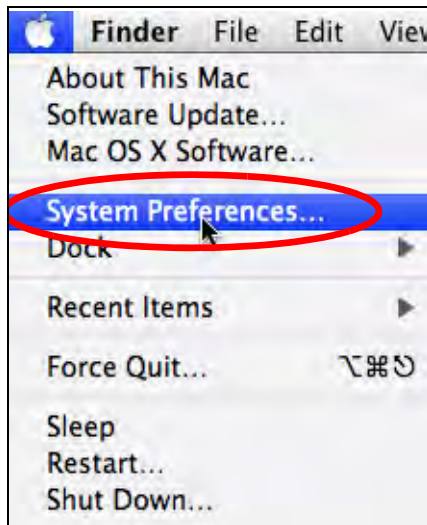

- 2 In **System Preferences**, click the **Network** icon.



- 3 When the **Network** preferences pane opens, select **Ethernet** from the list of available connection types.

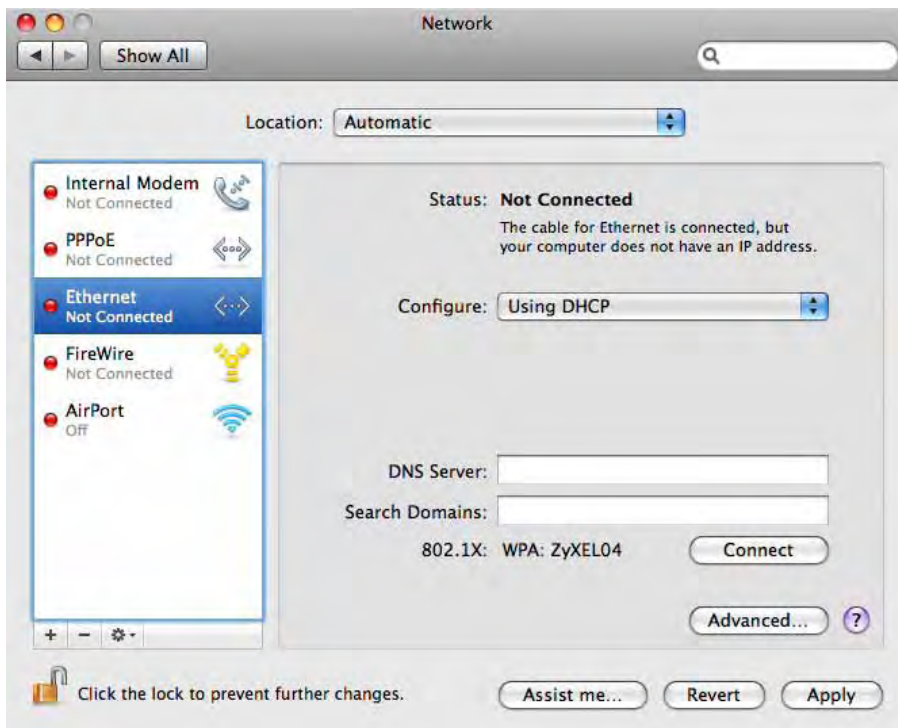

- 4 From the **Configure** list, select **Using DHCP** for dynamically assigned settings.

- 5 For statically assigned settings, do the following:
 - From the **Configure** list, select **Manually**.
 - In the **IP Address** field, enter your IP address.
 - In the **Subnet Mask** field, enter your subnet mask.
 - In the **Router** field, enter the IP address of your NBG6616.

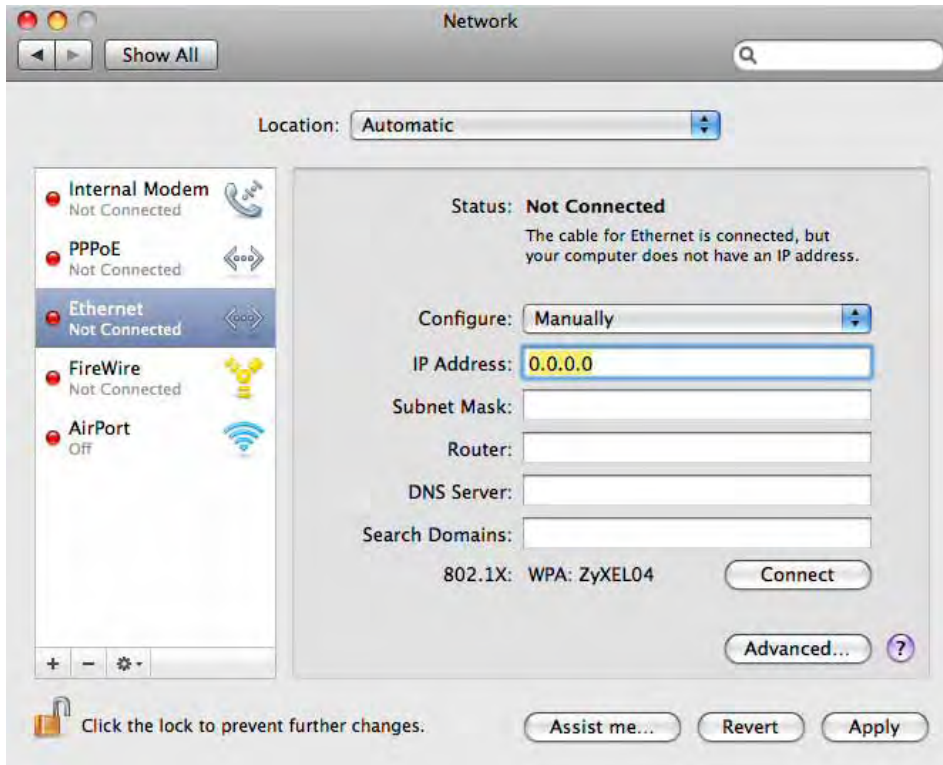

- 6 Click **Apply** and close the window.

Verifying Settings

Check your TCP/IP properties by clicking **Applications > Utilities > Network Utilities**, and then selecting the appropriate **Network interface** from the **Info** tab.

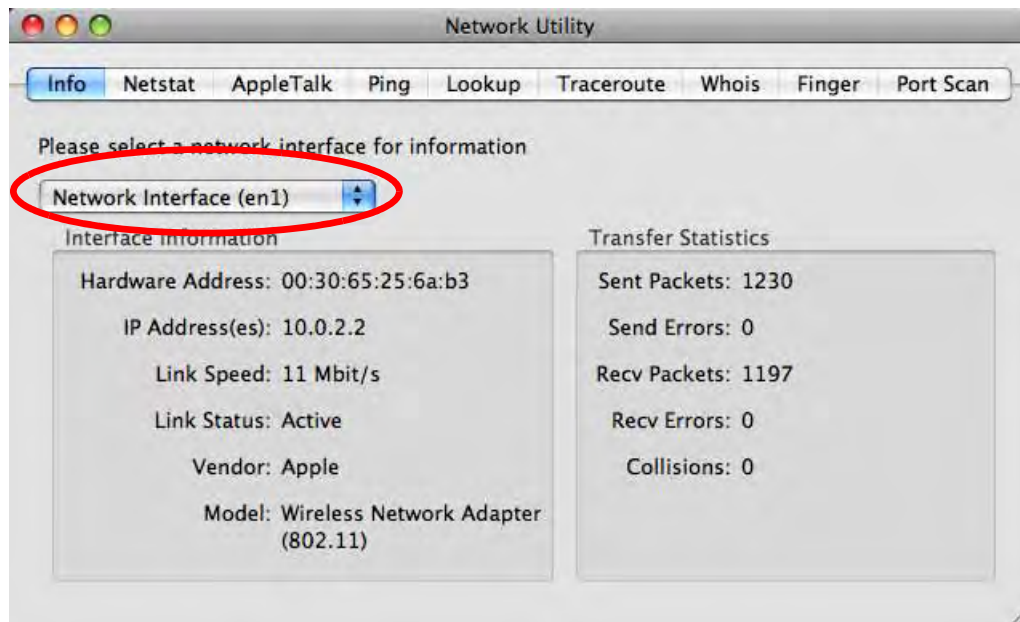
Figure 143 Mac OS X 10.5: Network Utility

Linux: Ubuntu 8 (GNOME)

This section shows you how to configure your computer's TCP/IP settings in the GNU Object Model Environment (GNOME) using the Ubuntu 8 Linux distribution. The procedure, screens and file locations may vary depending on your specific distribution, release version, and individual configuration. The following screens use the default Ubuntu 8 installation.

Note: Make sure you are logged in as the root administrator.

Follow the steps below to configure your computer IP address in GNOME:

- 1 Click **System > Administration > Network**.

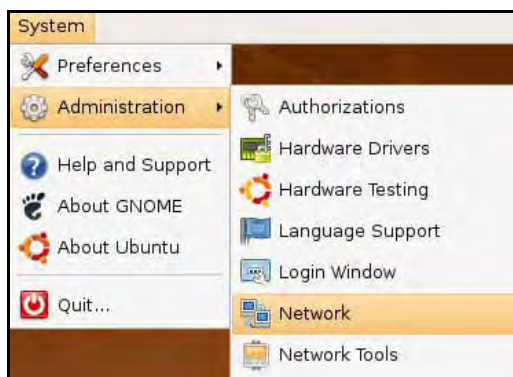

- 2 When the **Network Settings** window opens, click **Unlock** to open the **Authenticate** window. (By default, the **Unlock** button is greyed out until clicked.) You cannot make changes to your configuration unless you first enter your admin password.

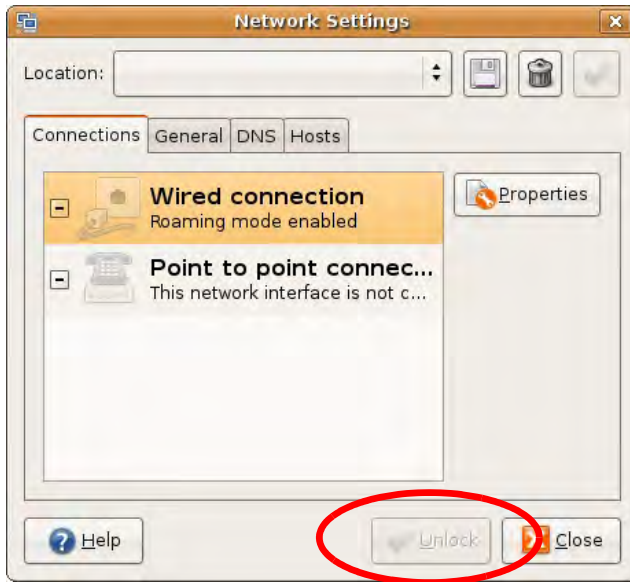

- 3 In the **Authenticate** window, enter your admin account name and password then click the **Authenticate** button.



- 4 In the **Network Settings** window, select the connection that you want to configure, then click **Properties**.



- 5 The **Properties** dialog box opens.



- In the **Configuration** list, select **Automatic Configuration (DHCP)** if you have a dynamic IP address.
 - In the **Configuration** list, select **Static IP address** if you have a static IP address. Fill in the **IP address**, **Subnet mask**, and **Gateway address** fields.
- 6 Click **OK** to save the changes and close the **Properties** dialog box and return to the **Network Settings** screen.
- 7 If you know your DNS server IP address(es), click the **DNS** tab in the **Network Settings** window and then enter the DNS server information in the fields provided.



- 8 Click the **Close** button to apply the changes.

Verifying Settings

Check your TCP/IP properties by clicking **System > Administration > Network Tools**, and then selecting the appropriate **Network device** from the **Devices** tab. The **Interface Statistics** column shows data if your connection is working properly.

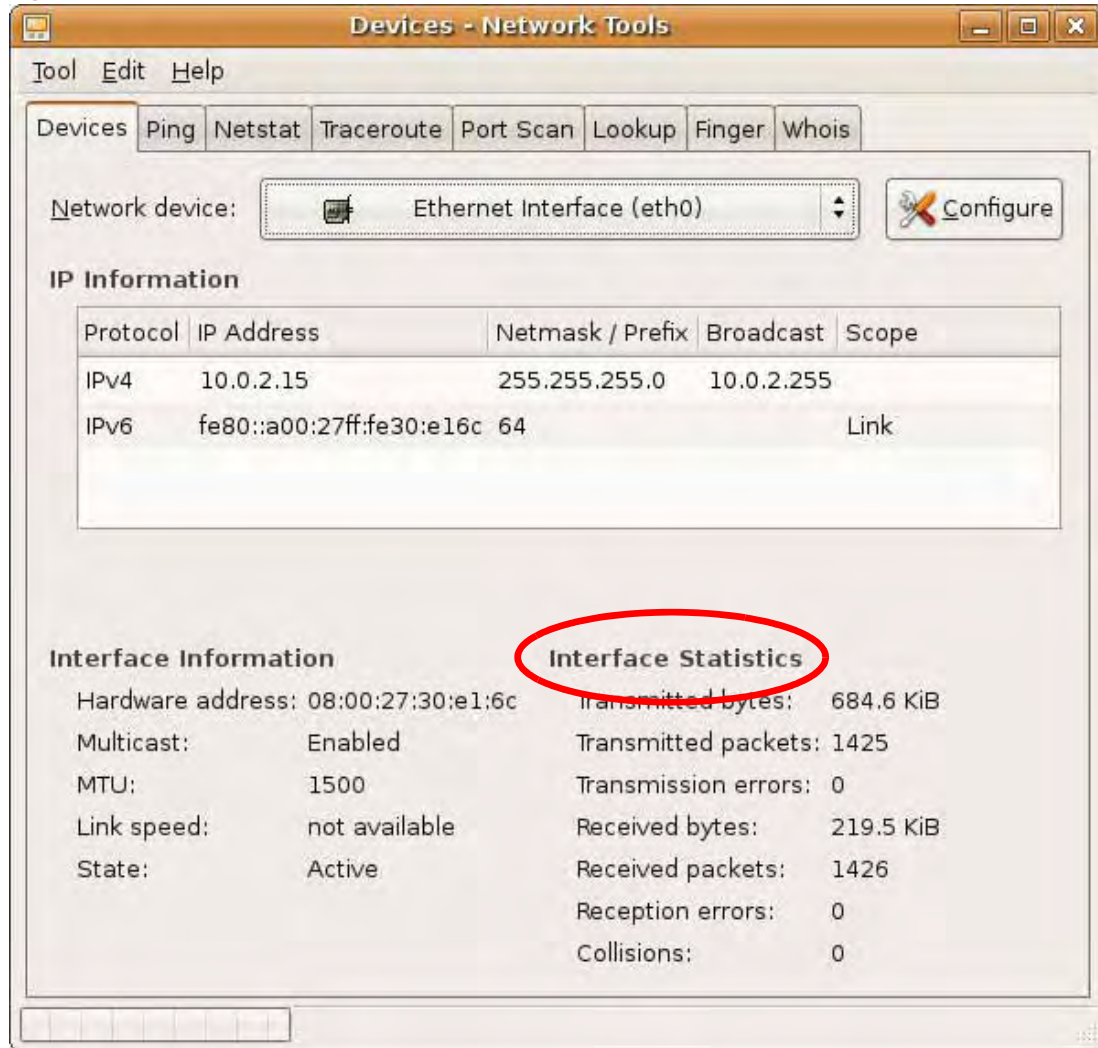
Figure 144 Ubuntu 8: Network Tools

Linux: openSUSE 10.3 (KDE)

This section shows you how to configure your computer's TCP/IP settings in the K Desktop Environment (KDE) using the openSUSE 10.3 Linux distribution. The procedure, screens and file locations may vary depending on your specific distribution, release version, and individual configuration. The following screens use the default openSUSE 10.3 installation.

Note: Make sure you are logged in as the root administrator.

Follow the steps below to configure your computer IP address in the KDE:

- 1 Click **K Menu > Computer > Administrator Settings (YaST)**.



- 2 When the **Run as Root - KDE su** dialog opens, enter the admin password and click **OK**.

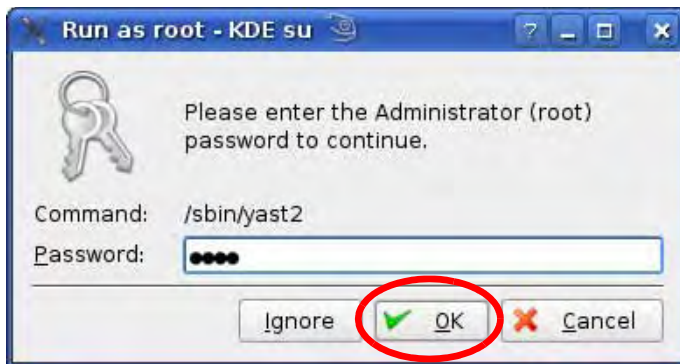

- 3 When the **YaST Control Center** window opens, select **Network Devices** and then click the **Network Card** icon.

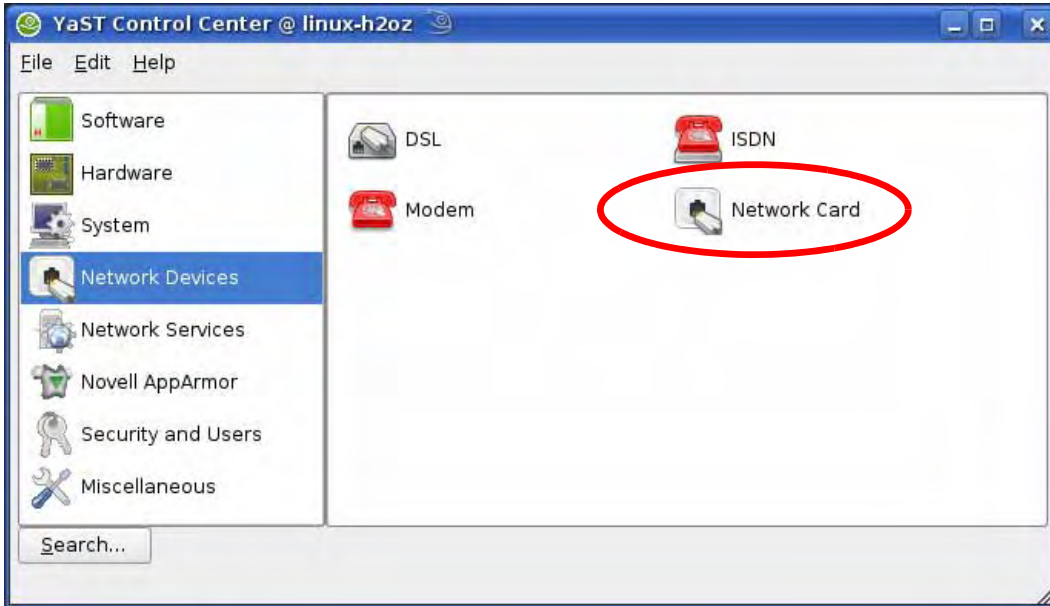

- 4 When the **Network Settings** window opens, click the **Overview** tab, select the appropriate connection **Name** from the list, and then click the **Configure** button.

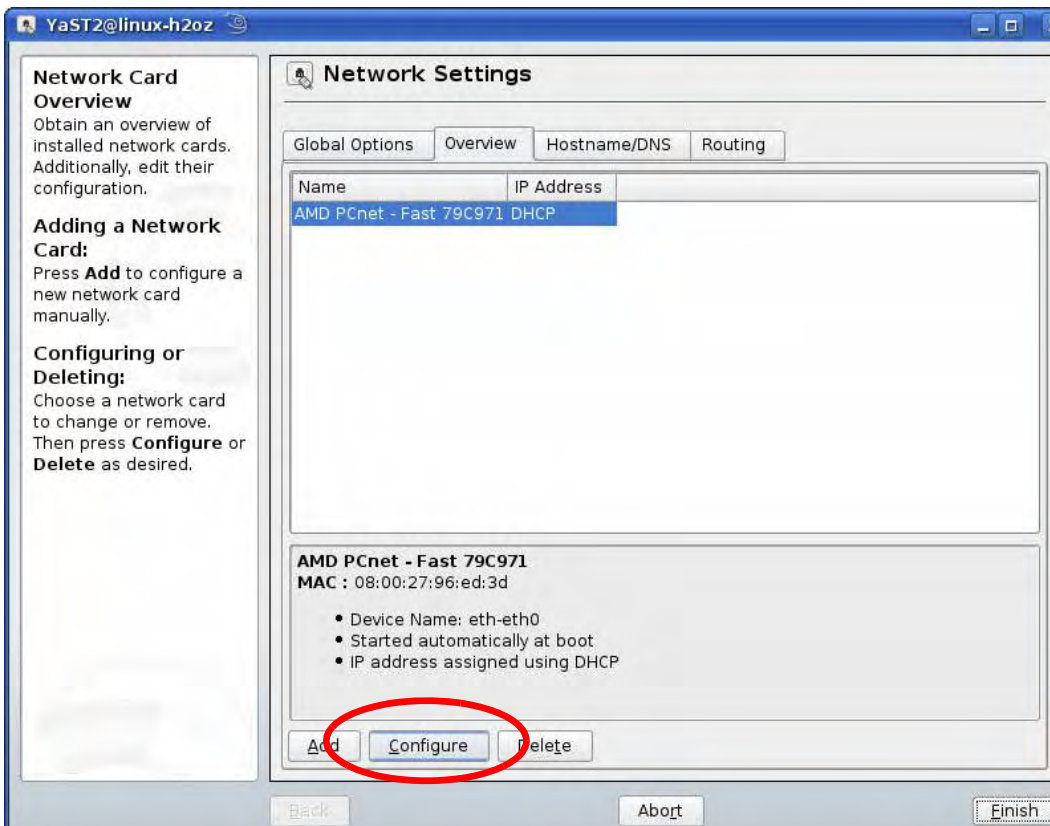

- 5 When the **Network Card Setup** window opens, click the **Address** tab

Figure 145 openSUSE 10.3: Network Card Setup

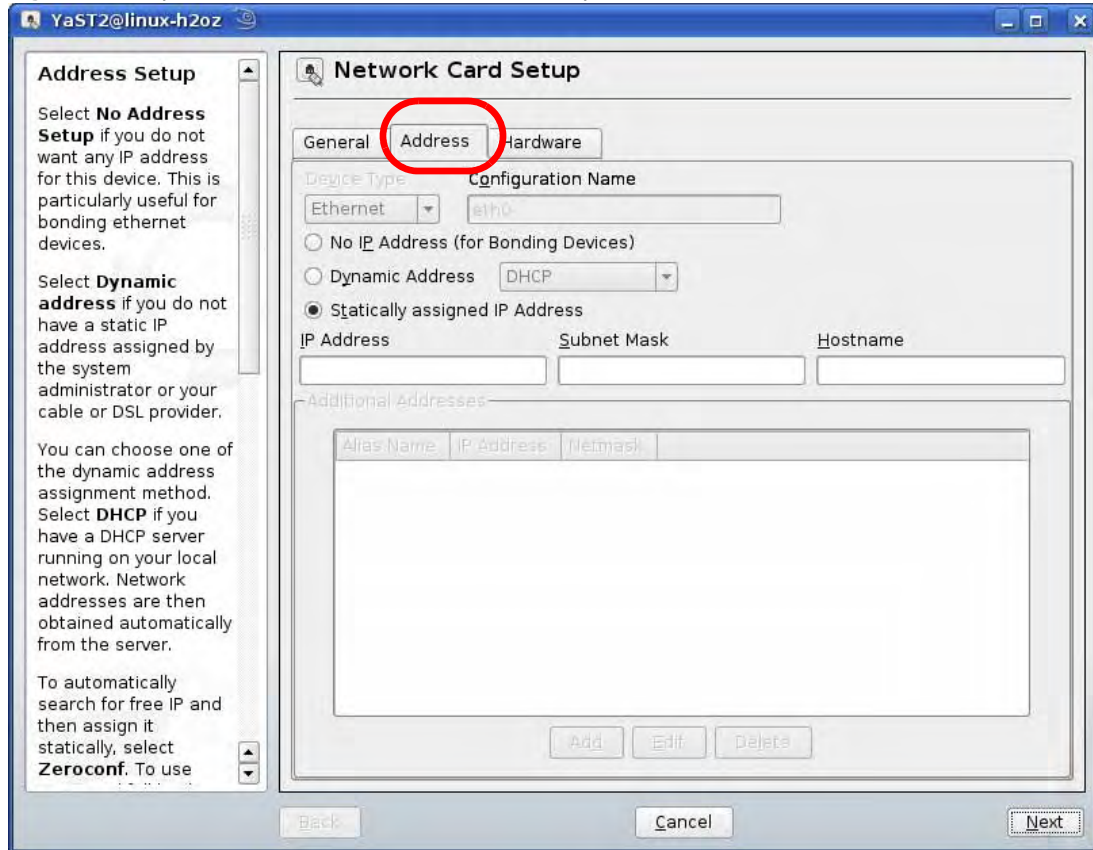

- 6 Select **Dynamic Address (DHCP)** if you have a dynamic IP address. Select **Statically assigned IP Address** if you have a static IP address. Fill in the **IP address**, **Subnet mask**, and **Hostname** fields.
- 7 Click **Next** to save the changes and close the **Network Card Setup** window.
- 8 If you know your DNS server IP address(es), click the **Hostname/DNS** tab in **Network Settings** and then enter the DNS server information in the fields provided.

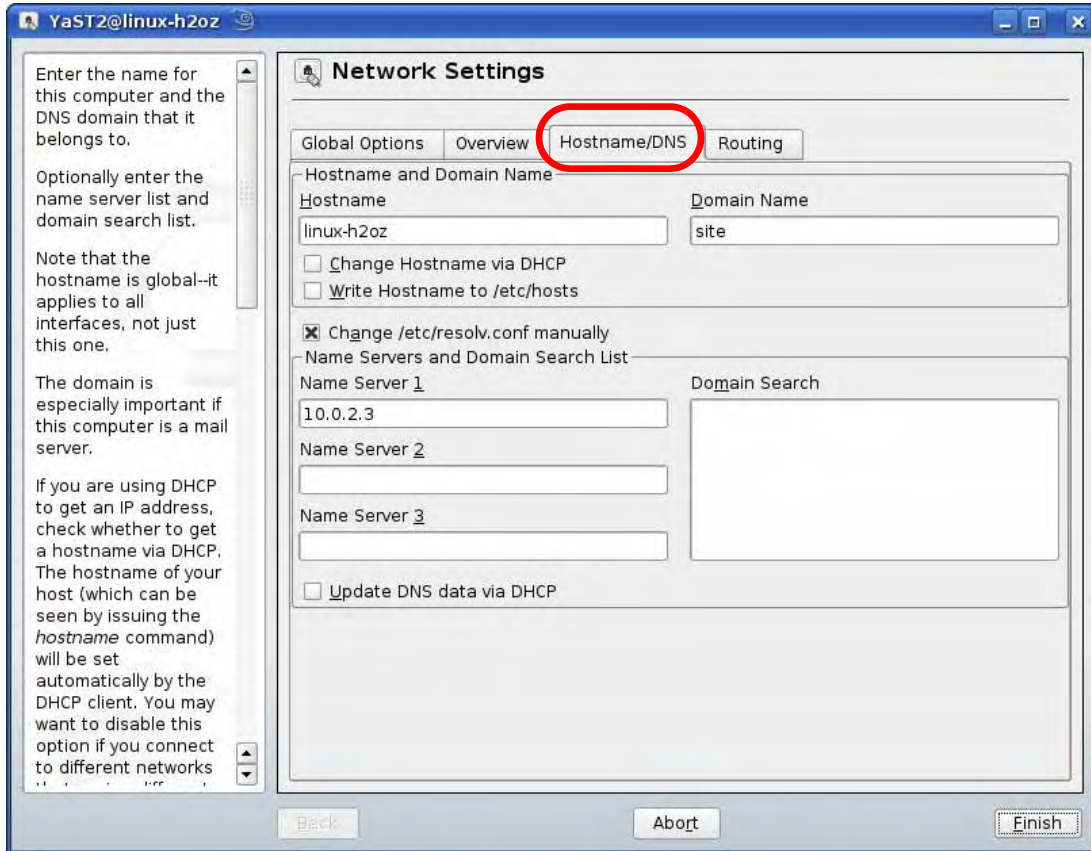

- Click **Finish** to save your settings and close the window.

Verifying Settings

Click the **KNetwork Manager** icon on the **Task bar** to check your TCP/IP properties. From the **Options** sub-menu, select **Show Connection Information**.

Figure 146 openSUSE 10.3: KNetwork Manager

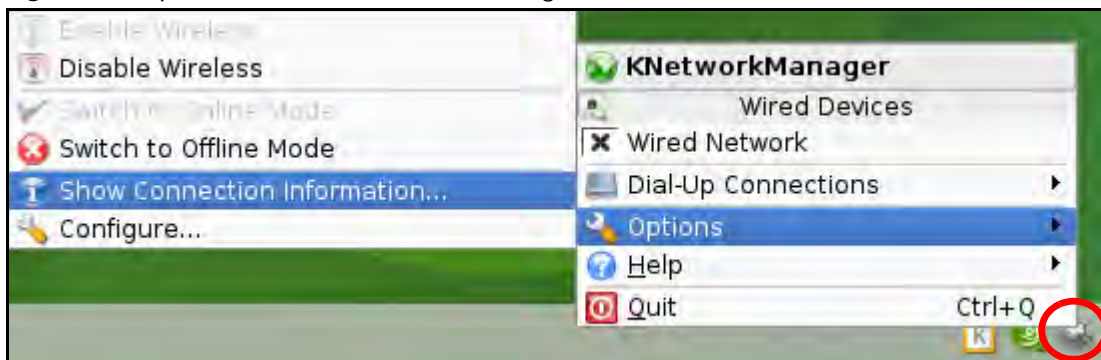

When the **Connection Status - KNetwork Manager** window opens, click the **Statistics tab** to see if your connection is working properly.

Figure 147 openSUSE: Connection Status - KNetwork Manager

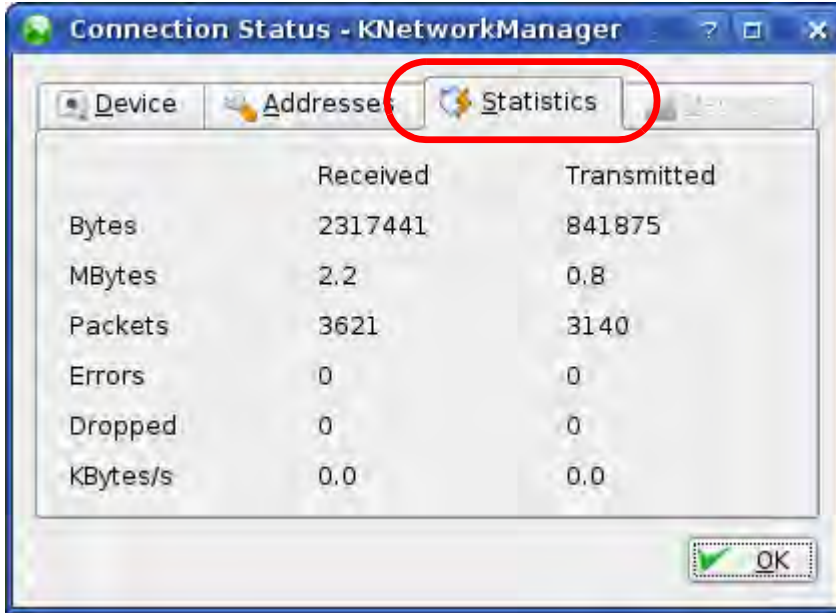

Common Services

The following table lists some commonly-used services and their associated protocols and port numbers. For a comprehensive list of port numbers, ICMP type/code numbers and services, visit the IANA (Internet Assigned Number Authority) web site.

- **Name:** This is a short, descriptive name for the service. You can use this one or create a different one, if you like.
- **Protocol:** This is the type of IP protocol used by the service. If this is **TCP/UDP**, then the service uses the same port number with TCP and UDP. If this is **USER-DEFINED**, the **Port(s)** is the IP protocol number, not the port number.
- **Port(s):** This value depends on the **Protocol**. Please refer to RFC 1700 for further information about port numbers.
 - If the **Protocol** is **TCP, UDP, or TCP/UDP**, this is the IP port number.
 - If the **Protocol** is **USER**, this is the IP protocol number.
- **Description:** This is a brief explanation of the applications that use this service or the situations in which this service is used.

Table 82 Commonly Used Services

NAME	PROTOCOL	PORT(S)	DESCRIPTION
AH (IPSEC_TUNNEL)	User-Defined	51	The IPSEC AH (Authentication Header) tunneling protocol uses this service.
AIM/New-ICQ	TCP	5190	AOL's Internet Messenger service. It is also used as a listening port by ICQ.
AUTH	TCP	113	Authentication protocol used by some servers.
BGP	TCP	179	Border Gateway Protocol.
BOOTP_CLIENT	UDP	68	DHCP Client.
BOOTP_SERVER	UDP	67	DHCP Server.
CU-SEEME	TCP UDP	7648 24032	A popular videoconferencing solution from White Pines Software.
DNS	TCP/UDP	53	Domain Name Server, a service that matches web names (for example www.zyxel.com) to IP numbers.
ESP (IPSEC_TUNNEL)	User-Defined	50	The IPSEC ESP (Encapsulation Security Protocol) tunneling protocol uses this service.
FINGER	TCP	79	Finger is a UNIX or Internet related command that can be used to find out if a user is logged on.
FTP	TCP TCP	20 21	File Transfer Program, a program to enable fast transfer of files, including large files that may not be possible by e-mail.
H.323	TCP	1720	NetMeeting uses this protocol.
HTTP	TCP	80	Hyper Text Transfer Protocol - a client/server protocol for the world wide web.

Table 82 Commonly Used Services (continued)

NAME	PROTOCOL	PORT(S)	DESCRIPTION
HTTPS	TCP	443	HTTPS is a secured http session often used in e-commerce.
ICMP	User-Defined	1	Internet Control Message Protocol is often used for diagnostic or routing purposes.
ICQ	UDP	4000	This is a popular Internet chat program.
IGMP (MULTICAST)	User-Defined	2	Internet Group Management Protocol is used when sending packets to a specific group of hosts.
IKE	UDP	500	The Internet Key Exchange algorithm is used for key distribution and management.
IRC	TCP/UDP	6667	This is another popular Internet chat program.
MSN Messenger	TCP	1863	Microsoft Networks' messenger service uses this protocol.
NEW-ICQ	TCP	5190	An Internet chat program.
NEWS	TCP	144	A protocol for news groups.
NFS	UDP	2049	Network File System - NFS is a client/server distributed file service that provides transparent file sharing for network environments.
NNTP	TCP	119	Network News Transport Protocol is the delivery mechanism for the USENET newsgroup service.
PING	User-Defined	1	Packet INternet Groper is a protocol that sends out ICMP echo requests to test whether or not a remote host is reachable.
POP3	TCP	110	Post Office Protocol version 3 lets a client computer get e-mail from a POP3 server through a temporary connection (TCP/IP or other).
PPTP	TCP	1723	Point-to-Point Tunneling Protocol enables secure transfer of data over public networks. This is the control channel.
PPTP_TUNNEL (GRE)	User-Defined	47	PPTP (Point-to-Point Tunneling Protocol) enables secure transfer of data over public networks. This is the data channel.
RCMD	TCP	512	Remote Command Service.
REAL_AUDIO	TCP	7070	A streaming audio service that enables real time sound over the web.
REXEC	TCP	514	Remote Execution Daemon.
RLOGIN	TCP	513	Remote Login.
RTELNET	TCP	107	Remote Telnet.
RTSP	TCP/UDP	554	The Real Time Streaming (media control) Protocol (RTSP) is a remote control for multimedia on the Internet.
SFTP	TCP	115	Simple File Transfer Protocol.
SMTP	TCP	25	Simple Mail Transfer Protocol is the message-exchange standard for the Internet. SMTP enables you to move messages from one e-mail server to another.
SNMP	TCP/UDP	161	Simple Network Management Program.
SNMP-TRAPS	TCP/UDP	162	Traps for use with the SNMP (RFC: 1215).

Table 82 Commonly Used Services (continued)

NAME	PROTOCOL	PORT(S)	DESCRIPTION
SQL-NET	TCP	1521	Structured Query Language is an interface to access data on many different types of database systems, including mainframes, midrange systems, UNIX systems and network servers.
SSH	TCP/UDP	22	Secure Shell Remote Login Program.
STRM WORKS	UDP	1558	Stream Works Protocol.
SYSLOG	UDP	514	Syslog allows you to send system logs to a UNIX server.
TACACS	UDP	49	Login Host Protocol used for (Terminal Access Controller Access Control System).
TELNET	TCP	23	Telnet is the login and terminal emulation protocol common on the Internet and in UNIX environments. It operates over TCP/IP networks. Its primary function is to allow users to log into remote host systems.
TFTP	UDP	69	Trivial File Transfer Protocol is an Internet file transfer protocol similar to FTP, but uses the UDP (User Datagram Protocol) rather than TCP (Transmission Control Protocol).
VDOLIVE	TCP	7000	Another videoconferencing solution.

Legal Information

Copyright

Copyright © 2014 by ZyXEL Communications Corporation.

The contents of this publication may not be reproduced in any part or as a whole, transcribed, stored in a retrieval system, translated into any language, or transmitted in any form or by any means, electronic, mechanical, magnetic, optical, chemical, photocopying, manual, or otherwise, without the prior written permission of ZyXEL Communications Corporation.

Published by ZyXEL Communications Corporation. All rights reserved.

Disclaimer

ZyXEL does not assume any liability arising out of the application or use of any products, or software described herein. Neither does it convey any license under its patent rights nor the patent rights of others. ZyXEL further reserves the right to make changes in any products described herein without notice. This publication is subject to change without notice.

Trademarks

Trademarks mentioned in this publication are used for identification purposes only and may be properties of their respective owners.

Certifications

Federal Communications Commission (FCC) Interference Statement

This device has been tested and found to comply with the limits for a Class B digital device pursuant to Part 15 of the FCC Rules. These limits are designed to provide reasonable protection against harmful interference in a residential installation. This device generates, uses, and can radiate radio frequency energy, and if not installed and used in accordance with the instructions, may cause harmful interference to radio communications. However, there is no guarantee that interference will not occur in a particular installation.

If this device does cause harmful interference to radio/television reception, which can be determined by turning the device off and on, the user is encouraged to try to correct the interference by one or more of the following measures:

- 1 Reorient or relocate the receiving antenna.
- 2 Increase the separation between the equipment and the receiver.
- 3 Connect the equipment into an outlet on a circuit different from that to which the receiver is connected.
- 4 Consult the dealer or an experienced radio/TV technician for help.

FCC Caution: Any changes or modifications not expressly approved by the party responsible for compliance could void the user's authority to operate this equipment.

The device complies with Part 15 of FCC rules. Operation is subject to the following two conditions:

- This device may not cause harmful interference.
- This device must accept any interference received, including interference that may cause undesired operations.
- This transmitter must not be co-located or operating in conjunction with any other antenna or transmitter. Operations in the 5.15-5.25GHz band are restricted to indoor usage only.

FCC Radiation Exposure Statement

- IEEE 802.11b, 802.11g or 802.11n (20MHz) operation of this product in the U.S.A. is firmware-limited to channels 1 through 11. IEEE 802.11n (40MHz) operation of this product in the U.S.A. is firmware-limited to channels 3 through 9.
- This equipment complies with FCC radiation exposure limits set forth for an uncontrolled environment. This equipment should be installed and operated with minimum distance 21 cm between the radiator & your body.

Industry Canada Statement

This device complies with RSS-210 of the Industry Canada Rules. Operation is subject to the following two conditions:

- 1) this device may not cause interference and
- 2) this device must accept any interference, including interference that may cause undesired operation of the device

Antenna having a higher gain is strictly prohibited per regulations of Industry Canada. The required antenna impedance is 50 ohms.

To reduce potential radio interference to other users, the antenna type and its gain should be so chosen that the EIRP is not more than required for successful communication.

IC Radiation Exposure Statement

This equipment complies with IC radiation exposure limits set forth for an uncontrolled environment. End users must follow the specific operating instructions for satisfying RF exposure compliance.

注意！

依據 低功率電波輻射性電機管理辦法

第十二條 經型式認證合格之低功率射頻電機，非經許可，公司、商號或使用
者均不得擅自變更頻率、加大功率或變更原設計之特性及功能。

第十四條 低功率射頻電機之使用不得影響飛航安全及干擾合法通信；經發現有干擾現象時，應立即停用，並改善至無干擾時方得繼續使用。前項合法通信，指依電信規定作業之無線電信。低功率射頻電機須忍受合法通信或工業、科學及醫療用電波輻射性電機設備之干擾。

在 5.25 - 5.35 GHz 頻帶內操作之無線資訊傳輸設備，限於室內使用。

電磁波曝露量 MPE 標準值 1mW/cm²，本產品使用時建議應距離人體 21 cm。

Notices

Changes or modifications not expressly approved by the party responsible for compliance could void the user's authority to operate the equipment.

This Class B digital apparatus complies with Canadian ICES-003.

Cet appareil numérique de la classe B est conforme à la norme NMB-003 du Canada.

Viewing Certifications

Go to <http://www.zyxel.com> to view this product's documentation and certifications.

ZyXEL Limited Warranty

ZyXEL warrants to the original end user (purchaser) that this product is free from any defects in material or workmanship for a specific period (the Warranty Period) from the date of purchase. The Warranty Period varies by region. Check with your vendor and/or the authorized ZyXEL local distributor for details about the Warranty Period of this product. During the warranty period, and upon proof of purchase, should the product have indications of failure due to faulty workmanship and/or materials, ZyXEL will, at its discretion, repair or replace the defective products or components without charge for either parts or labor, and to whatever extent it shall deem necessary to restore the product or components to proper operating condition. Any replacement will consist of a new or re-manufactured functionally equivalent product of equal or higher value, and will be solely at the discretion of ZyXEL. This warranty shall not apply if the product has been modified, misused, tampered with, damaged by an act of God, or subjected to abnormal working conditions.

Note

Repair or replacement, as provided under this warranty, is the exclusive remedy of the purchaser. This warranty is in lieu of all other warranties, express or implied, including any implied warranty of merchantability or fitness for a particular use or purpose. ZyXEL shall in no event be held liable for indirect or consequential damages of any kind to the purchaser.

To obtain the services of this warranty, contact your vendor. You may also refer to the warranty policy for the region in which you bought the device at http://www.zyxel.com/web/support_warranty_info.php.

Registration

Register your product online to receive e-mail notices of firmware upgrades and information at www.zyxel.com for global products, or at www.us.zyxel.com for North American products.

Open Source Licenses

This product contains in part some free software distributed under GPL license terms and/or GPL like licenses. Open source licenses are provided with the firmware package. You can download the latest firmware at www.zyxel.com. To obtain the source code covered under those Licenses, please contact support@zyxel.com.tw to get it.

Regulatory Information

European Union

The following information applies if you use the product within the European Union.

Declaration of Conformity with Regard to EU Directive 1999/5/EC (R&TTE Directive)

Compliance Information for 2.4GHz and 5GHz Wireless Products Relevant to the EU and Other Countries Following the EU Directive 1999/5/EC (R&TTE Directive)

[Czech]	ZyXEL tímto prohlašuje, že tento zařazení je ve shodě se základními požadavky a dalšími příslušnými ustanoveními směrnice 1999/5/EC.
[Danish]	Undertegnede ZyXEL erklærer herved, at følgende udstyr overholder de væsentlige krav og øvrige relevante krav i direktiv 1999/5/EF.
[German]	Hiermit erklärt ZyXEL, dass sich das Gerät Ausstattung in Übereinstimmung mit den grundlegenden Anforderungen und den übrigen einschlägigen Bestimmungen der Richtlinie 1999/5/EU befindet.
[Estonian]	Käesolevaga kinnitab ZyXEL seadme seadmed vastavust direktiivi 1999/5/EÜ põhinõuetele ja nimetatud direktiivist tulenevatele teistele asjakohastele sätetele.
English	Hereby, ZyXEL declares that this equipment is in compliance with the essential requirements and other relevant provisions of Directive 1999/5/EC.
[Spanish]	Por medio de la presente ZyXEL declara que el equipo cumple con los requisitos esenciales y cualesquiera otras disposiciones aplicables o exigibles de la Directiva 1999/5/CE.
[Greek]	ΜΕ ΤΗΝ ΠΑΡΟΥΣΑ ΖΥΧΕΛ ΔΗΛΩΝΕΙ ΟΤΙ ΕΞΟΛΙΣΜΟΣ ΣΥΜΜΟΡΦΩΝΕΤΑΙ ΠΡΟΣ ΤΙΣ ΟΥΣΙΩΔΕΙΣ ΑΠΑΙΤΗΣΕΙΣ ΚΑΙ ΤΙΣ ΛΟΙΠΕΣ ΣΧΕΤΙΚΕΣ ΔΙΑΤΑΞΕΙΣ ΤΗΣ ΟΔΗΓΙΑΣ 1999/5/ΕΚ.
[French]	Par la présente ZyXEL déclare que l'appareil équipements est conforme aux exigences essentielles et aux autres dispositions pertinentes de la directive 1999/5/EC.

[Italian]	Con la presente ZyXEL dichiara che questo attrezzatura è conforme ai requisiti essenziali ed alle altre disposizioni pertinenti stabilite dalla direttiva 1999/5/CE.
[Latvian]	Ar šo ZyXEL deklarē, ka iekārtas atbilst Direktīvas 1999/5/EK būtiskajām prasībām un citiem ar to saistītajiem noteikumiem.
[Lithuanian]	Šiuo ZyXEL deklaruoją, kad šis įranga atitinka esminius reikalavimus ir kitas 1999/5/EB Direktyvos nuostatas.
[Dutch]	Hierbij verklaart ZyXEL dat het toestel uitrusting in overeenstemming is met de essentiële eisen en de andere relevante bepalingen van richtlijn 1999/5/EC.
[Maltese]	Hawnhekk, ZyXEL, jiddikjara li dan tagħmir jikkonforma mal-ħtiġijiet essenzjali u ma provvedimenti oħrajn rilevanti li hemm fid-Dirrettiva 1999/5/EC.
[Hungarian]	Alulírott, ZyXEL nyilatkozom, hogy a berendezés megfelel a vonatkozó alapvető követelményeknek és az 1999/5/EK irányelv egyéb előírásainak.
[Polish]	Niniejszym ZyXEL oświadcza, że sprzęt jest zgodny z zasadniczymi wymogami oraz pozostałymi stosownymi postanowieniami Dyrektywy 1999/5/EC.
[Portuguese]	ZyXEL declara que este equipamento está conforme com os requisitos essenciais e outras disposições da Directiva 1999/5/EC.
[Slovenian]	ZyXEL izjavlja, da je ta oprema v skladu z bistvenimi zahtevami in ostalimi relevantnimi določili direktive 1999/5/EC.
[Slovak]	ZyXEL týmto vyhlasuje, že zariadenia spĺňa základné požiadavky a všetky príslušné ustanovenia Smernice 1999/5/EC.
[Finnish]	ZyXEL vakuuttaa täten että laitteet tyyppinen laite on direktiivin 1999/5/EY oleellisten vaatimusten ja sitä koskevien direktiivin muiden ehtojen mukainen.
[Swedish]	Härmed intygar ZyXEL att denna utrustning står i överensstämmelse med de väsentliga egenskapskrav och övriga relevanta bestämmelser som framgår av direktiv 1999/5/EC.
[Bulgarian]	С настоящото ZyXEL декларира, че това оборудване е в съответствие със съществените изисквания и другите приложими разпоредбите на Директива 1999/5/EC.
[Icelandic]	Hér með lýsir, ZyXEL því yfir að þessi búnaður er í samræmi við grunnkröfur og önnur viðeigandi ákvæði tilskipunar 1999/5/EC.
[Norwegian]	Erklærer herved ZyXEL at dette utstyret er i samsvar med de grunnleggende kravene og andre relevante bestemmelser i direktiv 1999/5/EF.
[Romanian]	Prin prezenta, ZyXEL declară că acest echipament este în conformitate cu cerințele esențiale și alte prevederi relevante ale Directivei 1999/5/EC.



National Restrictions

This product may be used in all EU countries (and other countries following the EU directive 1999/5/EC) without any limitation except for the countries mentioned below:

Ce produit peut être utilisé dans tous les pays de l'UE (et dans tous les pays ayant transposés la directive 1999/5/CE) sans aucune limitation, excepté pour les pays mentionnés ci-dessous:

Questo prodotto è utilizzabile in tutte i paesi EU (ed in tutti gli altri paesi che seguono le direttive EU 1999/5/EC) senza nessuna limitazione, eccetto per i paesi menzionati di seguito:

Das Produkt kann in allen EU Staaten ohne Einschränkungen eingesetzt werden (sowie in anderen Staaten die der EU Direktive 1995/5/CE folgen) mit Ausnahme der folgenden aufgeführten Staaten:

In the majority of the EU and other European countries, the 2, 4- and 5-GHz bands have been made available for the use of wireless local area networks (LANs). Later in this document you will find an overview of countries in which additional restrictions or requirements or both are applicable.

The requirements for any country may evolve. ZyXEL recommends that you check with the local authorities for the latest status of their national regulations for both the 2,4- and 5-GHz wireless LANs.

The following countries have restrictions and/or requirements in addition to those given in the table labeled "Overview of Regulatory Requirements for Wireless LANs":

Frequency Band (MHz)	Max Power Level (EIRP) ¹ (mW)	Indoor ONLY	Indoor and Outdoor
2400-2483.5	100		✓
5150-5350	200	✓	
5470-5725	1000		✓

Belgium

The Belgian Institute for Postal Services and Telecommunications (BIPT) must be notified of any outdoor wireless link having a range exceeding 300 meters. Please check <http://www.bipt.be> for more details.

Draadloze verbindingen voor buitengebruik en met een reikwijdte van meer dan 300 meter dienen aangemeld te worden bij het Belgisch Instituut voor postdiensten en telecommunicatie (BIPT). Zie <http://www.bipt.be> voor meer gegevens.

Les liaisons sans fil pour une utilisation en extérieur d'une distance supérieure à 300 mètres doivent être notifiées à l'Institut Belge des services Postaux et des Télécommunications (IBPT). Visitez <http://www.ibpt.be> pour de plus amples détails.

Denmark

In Denmark, the band 5150 - 5350 MHz is also allowed for outdoor usage.

I Danmark må frekvensbåndet 5150 - 5350 også anvendes udendørs.

Italy

This product meets the National Radio Interface and the requirements specified in the National Frequency Allocation Table for Italy. Unless this wireless LAN product is operating within the boundaries of the owner's property, its use requires a "general authorization." Please check <http://www.sviluppoeconomico.gov.it/> for more details.

Questo prodotto è conforme alla specifiche di Interfaccia Radio Nazionali e rispetta il Piano Nazionale di ripartizione delle frequenze in Italia. Se non viene installato all'interno del proprio fondo, l'utilizzo di prodotti Wireless LAN richiede una "Autorizzazione Generale". Consultare <http://www.sviluppoeconomico.gov.it/> per maggiori dettagli.

Latvia

The outdoor usage of the 2.4 GHz band requires an authorization from the Electronic Communications Office. Please check <http://www.esd.lv> for more details.

2.4 GHz frekvenču joslas izmantošanai ārpus telpām nepieciešama atļauja no Elektronisko sakaru direkcijas. Vairāk informācijas: <http://www.esd.lv>.

Notes:

1. Although Norway, Switzerland and Liechtenstein are not EU member states, the EU Directive 1999/5/EC has also been implemented in those countries.
2. The regulatory limits for maximum output power are specified in EIRP. The EIRP level (in dBm) of a device can be calculated by adding the gain of the antenna used (specified in dBi) to the output power available at the connector (specified in dBm).

List of national codes

COUNTRY	ISO 3166 2 LETTER CODE	COUNTRY	ISO 3166 2 LETTER CODE
Austria	AT	Malta	MT
Belgium	BE	Netherlands	NL
Cyprus	CY	Poland	PL
Czech Republic	CR	Portugal	PT
Denmark	DK	Slovakia	SK
Estonia	EE	Slovenia	SI
Finland	FI	Spain	ES
France	FR	Sweden	SE
Germany	DE	United Kingdom	GB
Greece	GR	Iceland	IS
Hungary	HU	Liechtenstein	LI
Ireland	IE	Norway	NO
Italy	IT	Switzerland	CH
Latvia	LV	Bulgaria	BG
Lithuania	LT	Romania	RO
Luxembourg	LU	Turkey	TR

Safety Warnings

- Do NOT use this product near water, for example, in a wet basement or near a swimming pool.
- Do NOT expose your device to dampness, dust or corrosive liquids.
- Do NOT store things on the device.
- Do NOT install, use, or service this device during a thunderstorm. There is a remote risk of electric shock from lightning.
- Connect ONLY suitable accessories to the device.
- Do NOT open the device or unit. Opening or removing covers can expose you to dangerous high voltage points or other risks. ONLY qualified service personnel should service or disassemble this device. Please contact your vendor for further information.
- Make sure to connect the cables to the correct ports.
- Place connecting cables carefully so that no one will step on them or stumble over them.
- Always disconnect all cables from this device before servicing or disassembling.
- Use ONLY an appropriate power adaptor or cord for your device.
- Connect the power adaptor or cord to the right supply voltage (for example, 110V AC in North America or 230V AC in Europe).
- Do NOT allow anything to rest on the power adaptor or cord and do NOT place the product where anyone can walk on the power adaptor or cord.
- Do NOT use the device if the power adaptor or cord is damaged as it might cause electrocution.
- If the power adaptor or cord is damaged, remove it from the power outlet.
- Do NOT attempt to repair the power adaptor or cord. Contact your local vendor to order a new one.
- Do not use the device outside, and make sure all the connections are indoors. There is a remote risk of electric shock from lightning.
- Do NOT obstruct the device ventilation slots, as insufficient airflow may harm your device.
- Antenna Warning! This device meets ETSI and FCC certification requirements when using the included antenna(s). Only use the included antenna(s).
- If you wall mount your device, make sure that no electrical lines, gas or water pipes will be damaged.

Your product is marked with this symbol, which is known as the WEEE mark. WEEE stands for Waste Electronics and Electrical Equipment. It means that used electrical and electronic products should not be mixed with general waste. Used electrical and electronic equipment should be treated separately.



Customer Support

In the event of problems that cannot be solved by using this manual, you should contact your vendor. If you cannot contact your vendor, then contact a ZyXEL office for the region in which you bought the device.

Regional websites are listed below.

See also http://www.zyxel.com/about_zyxel/zyxel_worldwide.shtml.

Please have the following information ready when you contact an office.

Required Information

- Product model and serial number.
- Warranty Information.
- Date that you received your device.
- Brief description of the problem and the steps you took to solve it.

Corporate Headquarters (Worldwide)

Taiwan

- ZyXEL Communications Corporation
- <http://www.zyxel.com>

Asia

China

- ZyXEL Communications (Shanghai) Corp.
- ZyXEL Communications (Beijing) Corp.
- ZyXEL Communications (Tianjin) Corp.
- <http://www.zyxel.cn>

India

- ZyXEL Technology India Pvt Ltd
- <http://www.zyxel.in>

Kazakhstan

- ZyXEL Kazakhstan
- <http://www.zyxel.kz>

Korea

- ZyXEL Korea Corp.
- <http://www.zyxel.kr>

Malaysia

- ZyXEL Malaysia Sdn Bhd.
- <http://www.zyxel.com.my>

Pakistan

- ZyXEL Pakistan (Pvt.) Ltd.
- <http://www.zyxel.com.pk>

Philippines

- ZyXEL Philippines
- <http://www.zyxel.com.ph>

Singapore

- ZyXEL Singapore Pte Ltd.
- <http://www.zyxel.com.sg>

Taiwan

- ZyXEL Communications Corporation
- <http://www.zyxel.com>

Thailand

- ZyXEL Thailand Co., Ltd
- <http://www.zyxel.co.th>

Vietnam

- ZyXEL Communications Corporation-Vietnam Office
- <http://www.zyxel.com/vn/vi>

Europe

Austria

- ZyXEL Deutschland GmbH
- <http://www.zyxel.de>

Belarus

- ZyXEL BY
- <http://www.zyxel.by>

Belgium

- ZyXEL Communications B.V.
- <http://www.zyxel.com/be/nl/>

Bulgaria

- ZyXEL България
- <http://www.zyxel.com/bg/bg/>

Czech

- ZyXEL Communications Czech s.r.o
- <http://www.zyxel.cz>

Denmark

- ZyXEL Communications A/S
- <http://www.zyxel.dk>

Estonia

- ZyXEL Estonia
- <http://www.zyxel.com/ee/et/>

Finland

- ZyXEL Communications
- <http://www.zyxel.fi>

France

- ZyXEL France
- <http://www.zyxel.fr>

Germany

- ZyXEL Deutschland GmbH
- <http://www.zyxel.de>

Hungary

- ZyXEL Hungary & SEE
- <http://www.zyxel.hu>

Latvia

- ZyXEL Latvia

- <http://www.zyxel.com/lv/lv/homepage.shtml>

Lithuania

- ZyXEL Lithuania
- <http://www.zyxel.com/lt/lt/homepage.shtml>

Netherlands

- ZyXEL Benelux
- <http://www.zyxel.nl>

Norway

- ZyXEL Communications
- <http://www.zyxel.no>

Poland

- ZyXEL Communications Poland
- <http://www.zyxel.pl>

Romania

- ZyXEL Romania
- <http://www.zyxel.com/ro/ro>

Russia

- ZyXEL Russia
- <http://www.zyxel.ru>

Slovakia

- ZyXEL Communications Czech s.r.o. organizacna zlozka
- <http://www.zyxel.sk>

Spain

- ZyXEL Spain
- <http://www.zyxel.es>

Sweden

- ZyXEL Communications
- <http://www.zyxel.se>

Switzerland

- Studerus AG

- <http://www.zyxel.ch/>

Turkey

- ZyXEL Turkey A.S.
- <http://www.zyxel.com.tr>

UK

- ZyXEL Communications UK Ltd.
- <http://www.zyxel.co.uk>

Ukraine

- ZyXEL Ukraine
- <http://www.ua.zyxel.com>

Latin America

Argentina

- ZyXEL Communication Corporation
- <http://www.zyxel.com/ec/es/>

Ecuador

- ZyXEL Communication Corporation
- <http://www.zyxel.com/ec/es/>

Middle East

Egypt

- ZyXEL Communication Corporation
- <http://www.zyxel.com/homepage.shtml>

Middle East

- ZyXEL Communication Corporation
- <http://www.zyxel.com/homepage.shtml>

North America

USA

- ZyXEL Communications, Inc. - North America Headquarters
- <http://www.us.zyxel.com/>

Oceania

Australia

- ZyXEL Communications Corporation
- <http://www.zyxel.com/au/en/>

Africa

South Africa

- Nology (Pty) Ltd.
- <http://www.zyxel.co.za>

A

ActiveX [136](#)
Address Assignment [75](#)
AP [12](#)
AP Mode
 menu [53](#)
 status screen [51](#)
AP+Bridge [12](#)

B

Bandwidth management
 overview [147](#)
 priority [149](#)
 services [153](#)
BitTorrent [153](#)
Bridge/Repeater [12](#)

C

certifications [231](#)
 notices [232](#)
 viewing [232](#)
Channel [44, 52](#)
channel [85](#)
CIFS [166](#)
Common Internet File System, see CIFS
Configuration
 restore [179](#)
contact information [236](#)
content filtering
 by keyword (in URL) [138](#)
Cookies [136](#)
copyright [231](#)
CPU usage [45, 52](#)
customer support [236](#)

D

Daylight saving [177](#)
DDNS [126](#)
 see also Dynamic DNS
 service providers [126, 144](#)
DHCP [70, 111](#)
 DHCP server
 see also Dynamic Host Configuration Protocol
DHCP server [108, 111](#)
Digital Living Network Alliance [165](#)
disclaimer [231](#)
DLNA [164, 165](#)
 indexing [167](#)
 overview [164](#)
 rescan [167](#)
DLNA-compliant client [165](#)
DNS [113](#)
DNS Server [75](#)
DNS server [113](#)
documentation
 related [2](#)
Domain Name System [113](#)
Domain Name System. See DNS.
duplex setting [45, 53](#)
Dynamic DNS [126](#)
Dynamic Host Configuration Protocol [111](#)
DynDNS [126, 144](#)
DynDNS see also DDNS [126, 144](#)

E

encryption [86](#)
 and local (user) database [87](#)
 key [87](#)
 WPA compatible [87](#)
ESSID [188](#)

F

- FCC interference statement [231](#)
- file sharing [165](#)
 - access right [168, 170](#)
 - bandwidth [170](#)
 - example [170](#)
 - FTP [169](#)
 - overview [165](#)
 - Samba [167](#)
 - user account [168, 169](#)
 - Windows Explorer [167](#)
 - work group [167](#)
- File Transfer Program [153](#)
- Firewall [132](#)
 - Firewall overview
 - guidelines [132](#)
 - ICMP packets [133](#)
 - network security
 - Stateful inspection [132](#)
- firewall
 - stateful inspection [131](#)
- Firmware upload [177](#)
 - file extension
 - using HTTP
- firmware version [44, 52](#)
- FTP. see also File Transfer Program [153](#)

G

- General wireless LAN screen [89](#)
- Guest WLAN [87](#)
- Guest WLAN Bandwidth [88](#)
- Guide
 - Quick Start [2](#)

H

- HTTP [153](#)
- Hyper Text Transfer Protocol [153](#)

I

- IGMP [76](#)
 - see also Internet Group Multicast Protocol
 - version
- IGMP version [76](#)
- Internet Group Multicast Protocol [76](#)
- IP Address [109, 119](#)
- IP alias [108](#)
- IP Pool [112](#)

J

- Java [136](#)

L

- LAN [107](#)
 - IP pool setup [108](#)
- LAN overview [107](#)
- LAN setup [107](#)
- LAN TCP/IP [108](#)
- Language [180](#)
- Link type [45, 53](#)
- local (user) database [86](#)
 - and encryption [87](#)
- Local Area Network [107](#)

M

- MAC [100](#)
- MAC address [75, 86](#)
 - cloning [75](#)
- MAC address filter [86](#)
- MAC address filtering [100](#)
- MAC filter [100](#)
- managing the device
 - good habits [13](#)
 - using the web configurator. See web configurator.
 - using the WPS. See WPS.
- MBSSID [12](#)

Media access control [100](#)
media client [164](#)
media file [164](#), [167](#)
 type [167](#)
media server [164](#)
 overview [164](#)
media file play [164](#)
Memory usage [45](#), [53](#)
mode [12](#)
Multicast [76](#)
 IGMP [76](#)

N

NAT [116](#), [119](#)
 global [117](#)
 how it works [118](#)
 inside [117](#)
 local [117](#)
 outside [117](#)
 overview [116](#)
 port forwarding [123](#)
 see also Network Address Translation
 server [117](#)
 server sets [123](#)
NAT Traversal [158](#)
Navigation Panel [45](#), [53](#)
navigation panel [45](#), [53](#)
Network Address Translation [116](#), [119](#)

O

operating mode [12](#)
other documentation [2](#)

P

P2P [153](#)
peer-to-peer [153](#)
Point-to-Point Protocol over Ethernet [79](#)
Pool Size [112](#)
Port forwarding [119](#), [123](#)

 default server [119](#), [123](#)
 example [123](#)
 local server [119](#)
 port numbers
 services
port speed [45](#), [53](#)
PPPoE [79](#)
 dial-up connection
product registration [232](#)

Q

Quality of Service (QoS) [102](#)
Quick Start Guide [2](#)

R

RADIUS server [86](#)
registration
 product [232](#)
related documentation [2](#)
Remote management
 and NAT [155](#)
 limitations [154](#)
 system timeout [155](#)
Reset button [13](#)
Reset the device [13](#)
Restore configuration [179](#)
Roaming [102](#)
Router Mode
 status screen [42](#)
RTS/CTS Threshold [85](#), [102](#)

S

Samba [166](#)
Scheduling [105](#)
Server Message Block, see SMB
Service and port numbers [135](#), [152](#)
Service Set [39](#), [89](#), [99](#)
Service Set IDentification [39](#), [89](#), [99](#)

Service Set IDentity. See SSID.
Session Initiated Protocol [153](#)
SIP [153](#)
SMB [166](#)
SSID [39](#), [44](#), [52](#), [85](#), [89](#), [99](#)
stateful inspection firewall [131](#)
Static DHCP [112](#)
Static Route [128](#)
Status [42](#)
Subnet Mask [109](#), [110](#)
Summary
 DHCP table [70](#)
 Packet statistics [71](#)
 Wireless station status [72](#)
System General Setup [174](#)
System restart [180](#)

T

TCP/IP configuration [111](#)
Time setting [176](#)
trademarks [231](#)
trigger port [124](#)
Trigger port forwarding [124](#)
 example [124](#)
 process [124](#)

U

Universal Plug and Play [158](#)
 Application [158](#)
 Security issues [158](#)
UPnP [158](#)
USB media sharing [164](#)
user authentication [86](#)
 local (user) database [86](#)
 RADIUS server [86](#)
User Name [127](#)

V

VoIP [153](#)

W

Wake On LAN [156](#)
WAN (Wide Area Network) [74](#)
WAN MAC address [75](#)
warranty [232](#)
 note [232](#)
Web Configurator
 how to access [17](#)
 Overview [17](#)
web configurator [12](#)
Web Proxy [137](#)
WEP Encryption [93](#), [95](#)
WEP encryption [92](#)
WEP key [92](#)
windows media player [164](#)
Wireless association list [72](#)
wireless channel [188](#)
wireless LAN [188](#)
wireless LAN scheduling [105](#)
Wireless network
 basic guidelines [85](#)
 channel [85](#)
 encryption [86](#)
 example [84](#)
 MAC address filter [86](#)
 overview [84](#)
 security [85](#)
 SSID [85](#)
Wireless security [85](#)
 overview [85](#)
 type [85](#)
wireless security [188](#)
Wireless tutorial [56](#)
Wizard setup [20](#)
WLAN button [13](#)
WoL [156](#)
work group [166](#)
 name [166](#)
 Windows [166](#)

World Wide Web [153](#)

WPA compatible [87](#)

WPS [12](#)

WWW [153](#)

X

Xbox Live [153](#)