



NBG6617

AC1300 MU-MIMO Dual-Band Wireless Gigabit Router

Version 1.00
Edition 2, 06/2016

User's Guide

Default Login Details

LAN IP Address	http://192.168.1.1 (Router Mode) http://192.168.1.2 (Access Point Mode)
Password	1234

IMPORTANT!

READ CAREFULLY BEFORE USE.

KEEP THIS GUIDE FOR FUTURE REFERENCE.

Screenshots and graphics in this book may differ slightly from your product due to differences in your product firmware or your computer operating system. Every effort has been made to ensure that the information in this manual is accurate.

Related Documentation

- Quick Start Guide

The Quick Start Guide shows how to connect the NBG6617 and access the Web Configurator wizards. It contains information on setting up your network and configuring for Internet access.

- More Information

Go to **support.zyxel.com** to find other information on the NBG6617.



Contents Overview

User's Guide	9
Introduction	10
Introducing the Web Configurator	15
eaZy 123 Wizard	18
NBG6617 Modes	27
Easy Mode	28
Router Mode	36
Access Point Mode	42
Tutorials	49
Technical Reference	59
Status	60
WAN	62
Wireless LAN	80
LAN	99
Applications	104
Security	129
Maintenance	135
Troubleshooting	149

Table of Contents

Contents Overview	3
Table of Contents	4
Part I: User's Guide	9
Chapter 1	
Introduction	10
1.1 Overview	10
1.2 Applications	10
1.3 Ways to Manage the NBG6617	10
1.4 Good Habits for Managing the NBG6617	11
1.5 Resetting the NBG6617	11
1.5.1 How to Use the RESET Button	11
1.6 The WPS Button	11
1.7 LEDs	12
1.8 Wall Mounting	13
Chapter 2	
Introducing the Web Configurator	15
2.1 Overview	15
2.2 Accessing the Web Configurator	15
2.2.1 Login Screen	16
2.2.2 Change Default Password Screen	16
Chapter 3	
eaZy 123 Wizard	18
3.1 Overview	18
3.2 Accessing the eaZy 123 Wizard	18
3.3 Internet Type	20
3.3.1 WAN Selection Type: Automatic - DHCP	21
3.3.2 WAN Selection Type: PPPoE	21
3.3.3 WAN Selection Type: Static	22
3.4 Wireless Network	23
Chapter 4	
NBG6617 Modes	27
4.1 Overview	27

4.1.1 Web Configurator Modes	27
4.1.2 Device Modes	27
Chapter 5	
Easy Mode	28
5.1 Overview	28
5.2 What You Can Do	28
5.3 What You Need to Know	29
5.4 Navigation Panel	29
5.5 Network Map	29
5.6 Control Panel	31
5.6.1 Wi-Fi	32
5.6.2 Guest Wi-Fi	33
5.6.3 Parental Control	34
5.6.4 Notification	34
Chapter 6	
Router Mode	36
6.1 Overview	36
6.2 Router Mode Status Screen	36
6.2.1 Navigation Panel	39
Chapter 7	
Access Point Mode	42
7.1 Overview	42
7.2 What You Can Do	42
7.3 What You Need to Know	42
7.3.1 Setting your NBG6617 to AP Mode	43
7.3.2 Accessing the Web Configurator in Access Point Mode	43
7.3.3 Configuring your WLAN and Maintenance Settings	44
7.4 AP Mode Status Screen	44
7.4.1 Navigation Panel	46
7.5 LAN Screen	46
Chapter 8	
Tutorials	49
8.1 Overview	49
8.2 Set Up a Wireless Network Using WPS	49
8.2.1 Push Button Configuration (PBC)	49
8.2.2 PIN Configuration	50
8.3 Connect to NBG6617 Wireless Network without WPS	51
8.3.1 Configure Your Notebook	53
8.4 Using Guest SSIDs on the NBG6617	55

8.4.1 Configuring Security Settings of Guest SSIDs56

Part II: Technical Reference 59

**Chapter 9
Status 60**

9.1 Overview60
 9.1.1 What You Can Do60
 9.2 Client Tables Screen60

**Chapter 10
WAN 62**

10.1 Overview62
 10.2 What You Can Do62
 10.3 What You Need To Know62
 10.3.1 Configuring Your Internet Connection63
 10.4 Internet Connection Screen65
 10.4.1 IPoE Encapsulation65
 10.4.2 PPPoE Encapsulation70
 10.5 NAT74
 10.5.1 General Screen74
 10.5.2 Port Trigger Screen76
 10.5.3 Passthrough Screen77
 10.6 Dynamic DNS Screen78

**Chapter 11
Wireless LAN 80**

11.1 Overview80
 11.1.1 What You Can Do81
 11.1.2 What You Should Know81
 11.2 Wireless Screen85
 11.3 Wireless Security87
 11.3.1 No Security87
 11.3.2 WPA-PSK/WPA2-PSK88
 11.3.3 WPA/WPA289
 11.4 Guest Wireless Screen91
 11.4.1 Guest Wireless Edit92
 11.5 MAC Filter Screen93
 11.6 Advanced Screen94
 11.7 WPS Screen96
 11.8 Scheduling Screen97

Chapter 12	
LAN	99
12.1 Overview	99
12.2 What You Can Do	99
12.3 What You Need To Know	99
12.4 LAN IP Screen	100
12.5 Static DHCP Screen	101
12.6 IPv6 LAN Screen	102
Chapter 13	
Applications	104
13.1 Overview	104
13.1.1 What You Can Do	104
13.1.2 What You Need To Know	104
13.1.3 Before You Begin	106
13.2 Parental Control	106
13.2.1 General Screen	106
13.2.2 Notification Screen	110
13.3 Bandwidth Management	112
13.3.1 General Screen	113
13.3.2 Advanced Screen	113
13.4 USB Media Sharing Screen	117
13.5 UPnP Screen	118
13.6 File Sharing	119
13.6.1 SAMBA Server Screen	120
13.6.2 FTP Server Screen	121
13.6.3 Example of Accessing Your Shared Files From a Computer	123
13.7 ONE Connect Screen	126
13.8 Technical Reference	127
Chapter 14	
Security	129
14.1 Overview	129
14.1.1 What You Can Do	129
14.1.2 What You Need To Know	129
14.2 IPv4 Firewall Screen	130
14.3 IPv6 Firewall Screen	132
Chapter 15	
Maintenance	135
15.1 Overview	135
15.2 What You Can Do	135
15.3 General Screen	135

Table of Contents

15.4 Password Screen	136
15.5 Time Screen	137
15.6 Firmware Upgrade Screen	139
15.7 Backup/Restore Screen	140
15.8 Restart Screen	141
15.9 Language Screen	141
15.10 Remote Management Screen	142
15.10.1 Remote Access	142
15.10.2 Wake On LAN	144
15.11 Log Screen	145
15.12 System Operation Mode Overview	146
15.13 Operation Mode Screen	147
Chapter 16	
Troubleshooting.....	149
16.1 Overview	149
16.2 Power, Hardware Connections, and LEDs	149
16.3 NBG6617 Access and Login	150
16.4 Internet Access	151
16.5 Resetting the NBG6617 to Its Factory Defaults	153
16.6 Wireless Connections	153
16.7 USB Device Problems	155
Appendix A Customer Support	156
Appendix B Setting Up Your Computer's IP Address	162
Appendix C Common Services	188
Appendix D Legal Information	191
Index	200

PART I

User's Guide

Introduction

1.1 Overview

This chapter introduces the main features and applications of the NBG6617.

The NBG6617 extends the range of your existing wired network without additional wiring, providing easy network access to mobile users. You can set up a wireless network with other IEEE 802.11a/b/g/n/ac compatible devices. The NBG6617 is able to function both 2.4GHz and 5GHz networks at the same time.

A range of services such as a firewall and content filtering are also available for secure Internet computing.

There is one USB 3.0 port on the side panel of your NBG6617. You can connect USB (version 3.0 or lower) memory sticks, USB hard drives, or USB devices for file sharing. The NBG6617 automatically detects the USB devices.

1.2 Applications

You can have the following networks with the NBG6617:

- **Wired.** You can connect network devices via the Ethernet ports of the NBG6617 so that they can communicate with each other and access the Internet.
- **Wireless.** Wireless clients can connect to the NBG6617 to access network resources. You can use WPS (Wi-Fi Protected Setup) to create an instant network connection with another WPS-compatible device.
- **WAN.** Connect to a broadband modem/router for Internet access.

1.3 Ways to Manage the NBG6617

Use any of the following methods to manage the NBG6617.

- **WPS (Wi-Fi Protected Setup).** You can use the WPS button or the WPS section of the Web Configurator to set up a wireless network with your NBG6617.
- **Web Configurator.** This is recommended for everyday management of the NBG6617 using a (supported) web browser.

1.4 Good Habits for Managing the NBG6617

Do the following things regularly to make the NBG6617 more secure and to manage the NBG6617 more effectively.

- Change the password. Use a password that's not easy to guess and that consists of different types of characters, such as numbers and letters.
- Write down the password and put it in a safe place.
- Back up the configuration (and make sure you know how to restore it). Restoring an earlier working configuration may be useful if the device becomes unstable or even crashes. If you forget your password, you will have to reset the NBG6617 to its factory default settings. If you backed up an earlier configuration file, you would not have to totally re-configure the NBG6617. You could simply restore your last configuration.

1.5 Resetting the NBG6617

If you forget your password or IP address, or you cannot access the Web Configurator, you will need to use the **RESET** button at the back of the NBG6617 to reload the factory-default configuration file. This means that you will lose all configurations that you had previously saved, the password will be reset to "1234" and the IP address will be reset to "192.168.1.1".

1.5.1 How to Use the RESET Button

- 1 Make sure the power LED is on.
- 2 Press the **RESET** button for one to four seconds to restart/reboot the NBG6617.
- 3 Press the **RESET** button for longer than five seconds to set the NBG6617 back to its factory-default configurations.

1.6 The WPS Button

Your NBG6617 supports Wi-Fi Protected Setup (WPS), which is an easy way to set up a secure wireless network. WPS is an industry standard specification, defined by the Wi-Fi Alliance.

WPS allows you to quickly set up a wireless network with strong security, without having to configure security settings manually. Each WPS connection works between two devices. Both devices must support WPS (check each device's documentation to make sure).

Depending on the devices you have, you can either press a button (on the device itself, or in its configuration utility) or enter a PIN (a unique Personal Identification Number that allows one device to authenticate the other) in each of the two devices. When WPS is activated on a device, it has two minutes to find another device that also has WPS activated. Then, the two devices connect and set up a secure network by themselves.

You can use the WPS button () on the top panel of the NBG6617 to activate WPS in order to quickly set up a wireless network with strong security.

- 1 Make sure the power LED is on (not blinking).
- 2 Press the WPS button for more than three seconds and release it. Press the WPS button on another WPS-enabled device within range of the NBG6617.

Note: You must activate WPS in the NBG6617 and in another wireless device within two minutes of each other.

For more information on using WPS, see [Section 8.2 on page 49](#).

1.7 LEDs

Figure 1 Top Panel, WPS Button and USB Slot

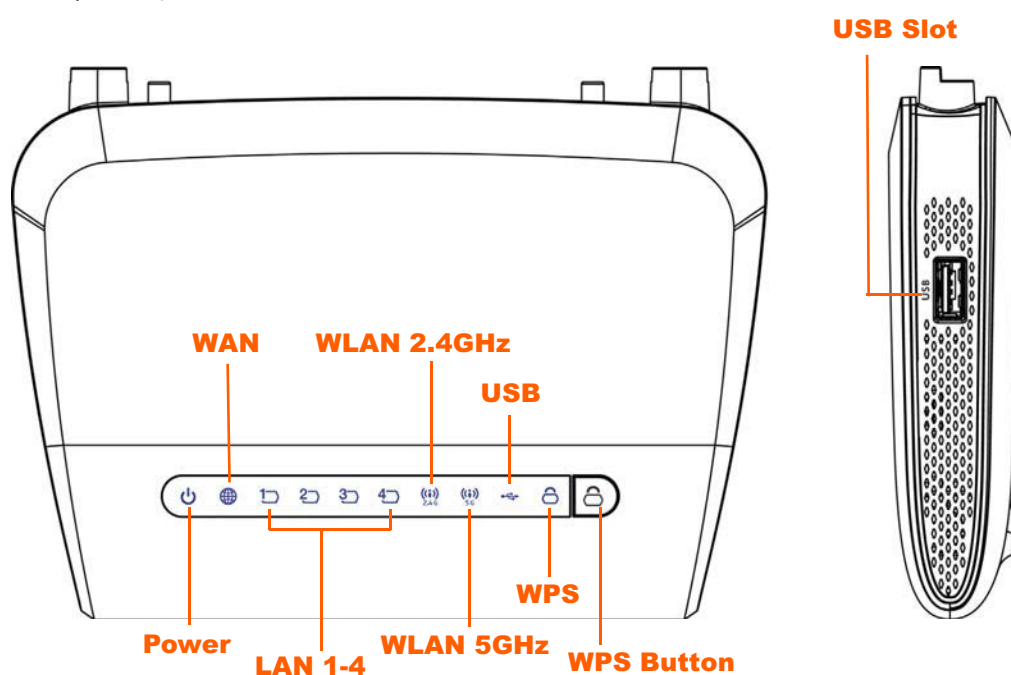

The following table describes the top panel LEDs.

Table 1 Top Panel LEDs

LED	COLOR	STATUS	DESCRIPTION
Power	Green	On	The NBG6617 is receiving power and functioning properly.
		Off	The NBG6617 is not receiving power.
WAN	Green	On	The NBG6617 has a successful 10/100/1000MB WAN connection.
		Blinking	The NBG6617 is sending/receiving data through the WAN.
		Off	The WAN connection is not ready, or has failed.
LAN 1-4	Green	On	The NBG6617 has a successful 10/100/1000MB Ethernet connection.
		Blinking	The NBG6617 is sending/receiving data through the LAN.
		Off	The LAN is not connected.

Table 1 Top Panel LEDs (continued)

LED	COLOR	STATUS	DESCRIPTION
WLAN 2.4GHz	Green	On	The NBG6617 is ready, but is not sending/receiving data through the wireless LAN 2.4 GHz band.
		Blinking	The NBG6617 is sending/receiving data through the wireless LAN 2.4 GHz band.
		Off	The wireless LAN 2.4 GHz band is not ready or has failed.
WLAN 5GHz	Green	On	The NBG6617 is ready, but is not sending/receiving data through the wireless LAN 5 GHz band.
		Blinking	The NBG6617 is sending/receiving data through the wireless LAN 5 GHz band.
		Off	The wireless LAN 5 GHz band is not ready or has failed.
USB	Green	On	The NBG6617 has a USB device installed.
		Blinking	The NBG6617 is transmitting and/or receiving data from routers through an installed USB device.
		Off	There is no USB device connected to the NBG6617.
WPS	Green	On	WPS is enabled.
		Blinking	The NBG6617 is negotiating a WPS connection with a wireless client.
		Off	WPS is disabled.

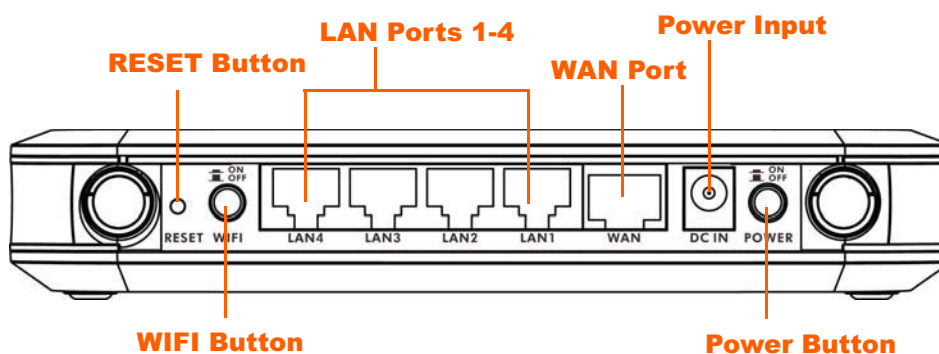
Figure 2 Rear Panel

1.8 Wall Mounting

You may need screw anchors if mounting on a concrete or brick wall.

Table 2 Wall Mounting Information

<u>Distance between holes</u>	<u>12.356 cm</u>
<u>M4 Screws</u>	<u>Two</u>
<u>Screw anchors (optional)</u>	<u>Two</u>

- Select a position free of obstructions on a wall strong enough to hold the weight of the device.

- 2 Mark two holes on the wall at the appropriate distance apart for the screws.

Be careful to avoid damaging pipes or cables located inside the wall when drilling holes for the screws.

- 3 If using screw anchors, drill two holes for the screw anchors into the wall. Push the anchors into the full depth of the holes, then insert the screws into the anchors. Do not insert the screws all the way in - leave a small gap of about 0.5 cm.

If not using screw anchors, use a screwdriver to insert the screws into the wall. Do not insert the screws all the way in - leave a gap of about 0.5 cm.

- 4 Make sure the screws are fastened well enough to hold the weight of the NBG6617 with the connection cables.

- 5 Align the holes on the back of the NBG6617 with the screws on the wall. Hang the NBG6617 on the screws.

Figure 3 Wall Mounting Example

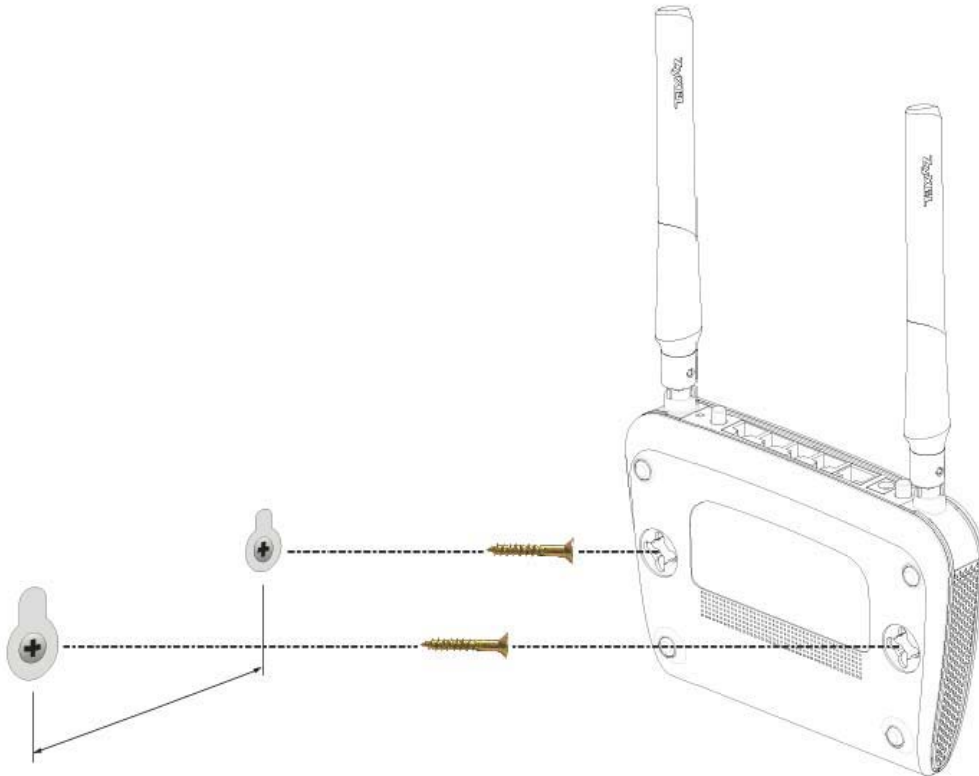

Introducing the Web Configurator

2.1 Overview

This chapter describes how to access the NBG6617 Web Configurator and provides an overview of its screens.

The Web Configurator is an HTML-based management interface that allows easy setup and management of the NBG6617 via Internet browser. Use a browser that supports HTML5, such as Internet Explorer 9.0 and later versions, Mozilla Firefox 21 and later versions, Safari 6.0 and later versions or Google Chrome 26.0 and later versions. The recommended screen resolution is 1024 by 768 pixels.

In order to use the Web Configurator you need to allow:

- Web browser pop-up windows from your device. Web pop-up blocking is enabled by default in Windows XP SP (Service Pack) 2.
- JavaScript (enabled by default).
- Java permissions (enabled by default).

Refer to the Troubleshooting chapter ([Chapter 16 on page 149](#)) to see how to make sure these functions are allowed in Internet Explorer.

2.2 Accessing the Web Configurator

- 1 Make sure your NBG6617 hardware is properly connected and prepare your computer or computer network to connect to the NBG6617 (refer to the Quick Start Guide).
- 2 Launch your web browser.
- 3 The NBG6617 is in router mode by default. Type "http://192.168.1.1" as the website address. If the NBG6617 obtains a WAN IP address or a DNS server IP address in the same subnet as the LAN IP address 192.168.1.1, the default LAN IP address will be changed to 10.0.0.1 automatically. See [Auto-IP Change on page 64](#) for more information.

If the NBG6617 is in access point, the IP address is 192.168.1.2. See [Chapter 4 on page 27](#) for more information about the modes of the NBG6617.

Your computer must be in the same subnet in order to access this website address.

2.2.1 Login Screen

Note: If this is the first time you are accessing the Web Configurator, you may be redirected to the eaZy123 wizard. Refer to [Chapter 3 on page 18](#) for the eaZy123 setup screens.

The Web Configurator initially displays the following login screen.

Figure 4 Login screen



The following table describes the labels in this screen.

Table 3 Login screen

LABEL	DESCRIPTION
Please enter the device's administrator password	Type "1234" (default) as the password. Click Login .

2.2.2 Change Default Password Screen

You should see a screen asking you to change your password (highly recommended) as shown next.

Figure 5 Change Default Password Screen

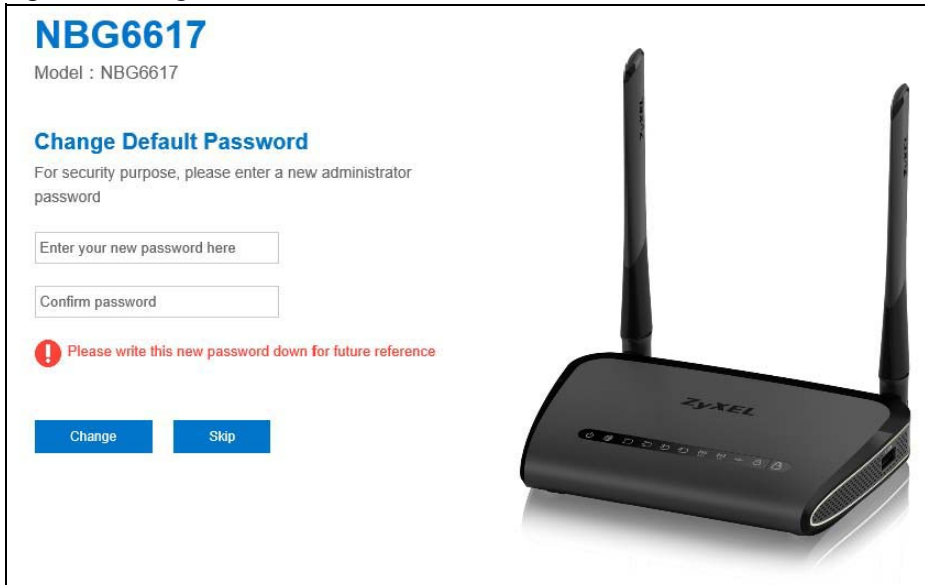

The following table describes the labels in this screen.

Table 4 Change Default Password Screen

LABEL	DESCRIPTION
Enter your new password here	Type a new password.
Confirm password	Retype the password for confirmation.
Change	Click Change to save your changes back to the NBG6617.
Skip	Click Skip if you do not want to change the password this time.

Note: The management session automatically times out when the time period set in the **Administrator Inactivity Timer** field expires (default five minutes; go to [Chapter 15 on page 135](#) to change this). Simply log back into the NBG6617 if this happens.

eaZy 123 Wizard

3.1 Overview

This chapter provides information on the eaZy 123 setup screens in the Web Configurator.

The Web Configurator's eaZy 123 setup wizard helps you configure your device to access the Internet. Refer to your ISP for your Internet account information. Leave a field blank if you don't have that information.

3.2 Accessing the eaZy 123 Wizard

Launch your web browser and type "http://192.168.1.1" as the website address. Type "1234" (default) as the password and click **Login**.

Note: The eaZy 123 wizard appears automatically when the NBG6617 is accessed for the first time or when you reset the NBG6617 to its default factory settings. If you didn't configure the wizard screens, you will be redirected to the login page when you connect to the Internet.

If you have already configured the wizard screens and want to open it again, click  on the upper right corner of any Web Configurator screen. The eaZy 123 wizard attempts to detect which WAN connection type you are using.

If the eaZy 123 wizard does not detect a connection type, you must select one from the drop-down list box. Check with your ISP to make sure you use the correct type.

If you do not have the Internet connection, the following screen opens.

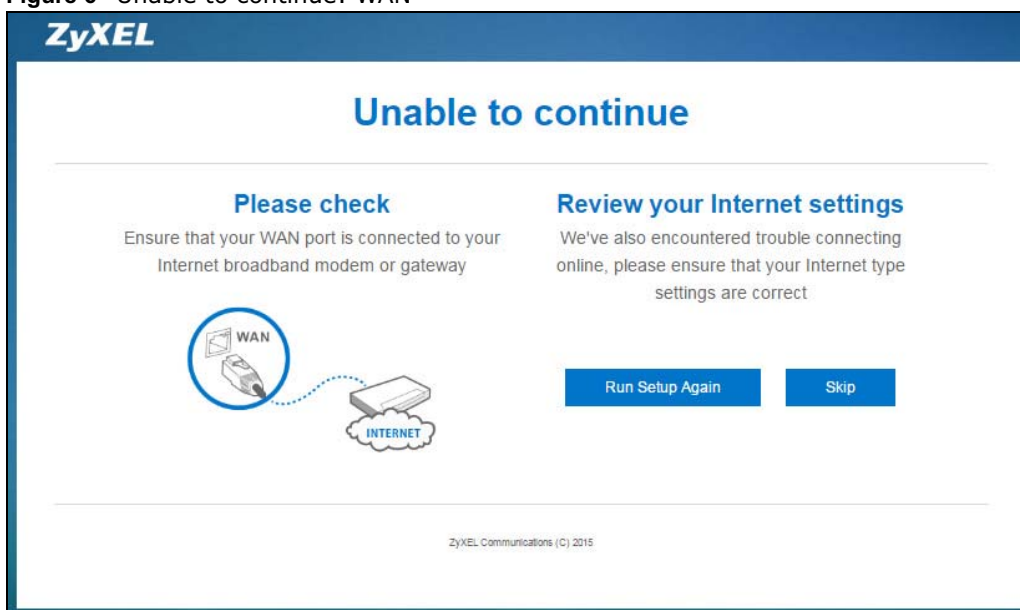
Figure 6 Unable to continue: WAN

If you do not press the Wi-Fi button located on the NBG6617's rear panel, the following screen opens.

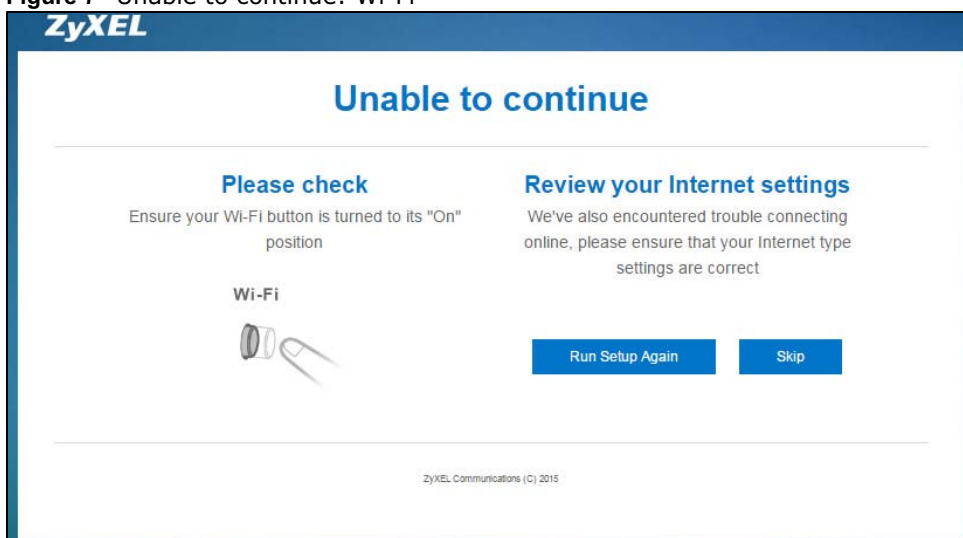
Figure 7 Unable to continue: Wi-Fi

Note: If you get an error message, check your hardware connections. Make sure your Internet connection is up and running.

The wizard screen opens.

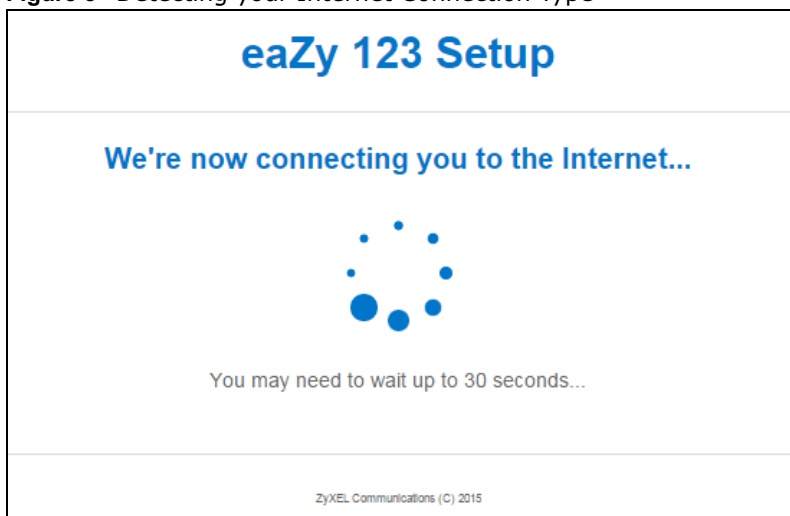
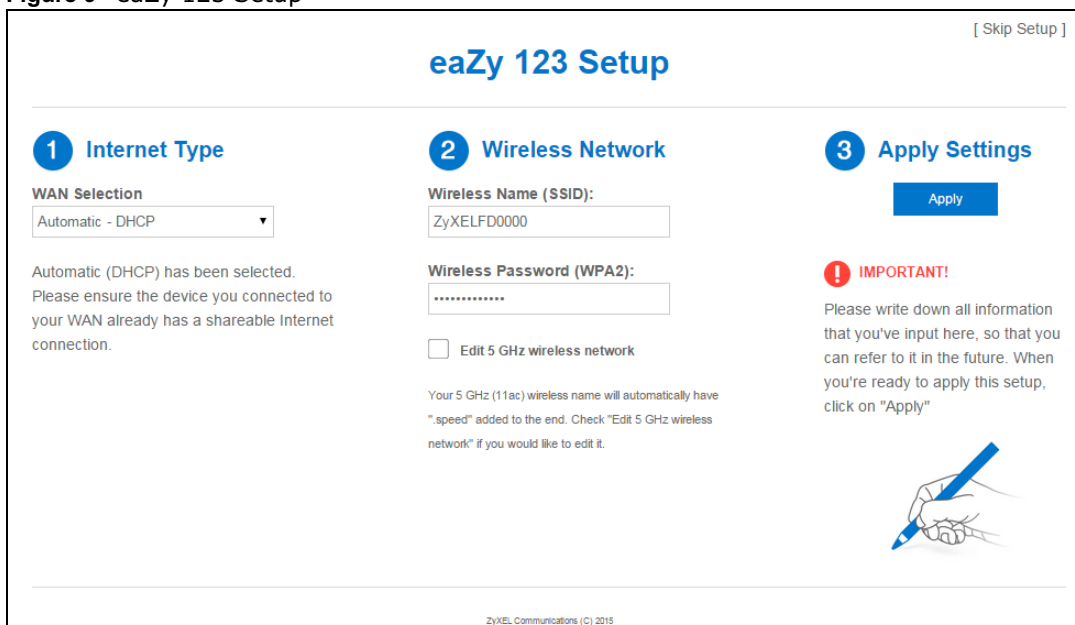
Figure 8 Detecting your Internet Connection Type**Figure 9** eaZy 123 Setup

3.3 Internet Type

The NBG6617 offers three WAN selection types. They are **Automatic - DHCP**, **PPPoE** or **Static**. Configure the Internet type settings on your NBG6617 in the first part. The following screen depends on your Internet connection type. Enter the details provided by your Internet Service Provider (ISP) in the fields (if any).

Check with your ISP to make sure you use the correct type. This wizard screen varies according to the connection type that you select.

3.3.1 WAN Selection Type: Automatic - DHCP

Select the **Automatic - DHCP** option if your ISP did not assign you a fixed IP address.

Figure 10 WAN Selection Type: Automatic - DHCP

The screenshot shows the 'eaZy 123 Setup' wizard with three main steps: 1. Internet Type, 2. Wireless Network, and 3. Apply Settings. Step 1 is highlighted with a blue box. In Step 1, 'Automatic - DHCP' is selected under 'WAN Selection'. Step 2 shows 'ZyXELFD0000' for 'Wireless Name (SSID)' and a password field. Step 3 has an 'Apply' button and an 'IMPORTANT!' warning to write down the information. A hand holding a pen is shown at the bottom right of the wizard.

3.3.2 WAN Selection Type: PPPoE

Point-to-Point Protocol over Ethernet (PPPoE) functions as a dial-up connection. PPPoE is an IETF (Internet Engineering Task Force) standard specifying how a host personal computer interacts with a broadband modem (for example DSL, cable, wireless, etc.) to achieve access to high-speed data networks.

For the service provider, PPPoE offers an access and authentication method that works with existing access control systems (for instance, RADIUS).

One of the benefits of PPPoE is the ability to let end users access one of multiple network services, a function known as dynamic service selection. This enables the service provider to easily create and offer new IP services for specific users.

Operationally, PPPoE saves significant effort for both the subscriber and the ISP/carrier, as it requires no specific configuration of the broadband modem at the subscriber's site.

By implementing PPPoE directly on the NBG6617 (rather than individual computers), the computers on the LAN do not need PPPoE software installed, since the NBG6617 does that part of the task. Furthermore, with NAT, all of the LAN's computers will have Internet access.

Figure 11 WAN Selection Type: PPPoE

[Skip Setup]

eaZy 123 Setup

1 Internet Type

WAN Selection

PPPoE

PPPoE Username:

yourname@isp.com

PPPoE Password:

yourisp-password

Static IP (Optional):

123.123.123.123

Please input your PPPoE username and password. This information is provided by your Internet Service Provider. Usually this Internet type is for DSL users.

2 Wireless Network

Wireless Name (SSID):

ZyXELFD0000

Wireless Password (WPA2):

.....

Edit 5 GHz wireless network

5 GHz Wireless Name (SSID):

ZyXELFD0000.speed

5 GHz Wireless Password (WPA2):

.....

Your 5 GHz (11ac) wireless name will automatically have "speed" added to the end. Check "Edit 5 GHz wireless network" if you would like to edit it.

3 Apply Settings

Apply

! IMPORTANT!

Please write down all information that you've input here, so that you can refer to it in the future. When you're ready to apply this setup, click on "Apply"

ZyXEL Communications (C) 2015

The following table describes the labels in this screen.

Table 5 WAN Selection Type: PPPoE

LABEL	DESCRIPTION
WAN Selection	Select the PPPoE (Point-to-Point Protocol over Ethernet) option for a dial-up connection.
PPPoE Username	Type the user name given to you by your ISP.
PPPoE Password	Type the password associated with the user name above.
Static IP (Optional)	Enter the WAN IP address assigned by your ISP.

Note: If you get an error message, make sure you have entered the correct information provided by your ISP.

3.3.3 WAN Selection Type: Static

Choose **Static** as the **WAN Selection Type** when the WAN port is used as a regular Ethernet. Click **Next**.

Figure 12 WAN Selection Type: Static

[Skip Setup]

eaZy 123 Setup

1 Internet Type

WAN Selection

Static

IP Address:

123.123.123.123

Subnet mask:

255.255.255.0

Gateway IP Address (Optional):

8.8.8.8

Please input your static IP information. This information is provided by your Internet Service Provider.

2 Wireless Network

Wireless Name (SSID):

ZyXELFD0000

Wireless Password (WPA2):

.....

Edit 5 GHz wireless network

5 GHz Wireless Name (SSID):

ZyXELFD0000.speed

5 GHz Wireless Password (WPA2):

.....

Your 5 GHz (11ac) wireless name will automatically have ".speed" added to the end. Check "Edit 5 GHz wireless network" if you would like to edit it.

3 Apply Settings

Apply

! IMPORTANT!

Please write down all information that you've input here, so that you can refer to it in the future. When you're ready to apply this setup, click on "Apply"

ZyXEL Communications (C) 2015

The following table describes the labels in this screen.

Table 6 WAN Selection Type: Static

LABEL	DESCRIPTION
WAN Selection	Select the Static option when the WAN port is using a fixed IP address.
IP Address	Enter the IP address provided by your ISP.
Subnet Mask	Enter the IP subnet mask in this field.
Gateway IP Address (Optional)	Enter the gateway IP address in this field.

Note: If you get an error screen, make sure your Internet connection is working and select the right WAN Selection Type. Contact your ISP if you are not sure of your Internet Connection type.

3.4 Wireless Network

Configure the wireless network settings on your NBG6617 in the second part. The default wireless security setting is WPA2-PSK.

Figure 13 Wireless Network

[Skip Setup]

eaZy 123 Setup

1 Internet Type

WAN Selection
PPPoE

PPPoE Username:
yourname@isp.com

PPPoE Password:
yourisp-password

Static IP (Optional):
123.123.123.123

Please input your PPPoE username and password. This information is provided by your Internet Service Provider. Usually this Internet type is for DSL users.

2 Wireless Network

Wireless Name (SSID):
ZyXELFD0000

Wireless Password (WPA2):

Edit 5 GHz wireless network

5 GHz Wireless Name (SSID):
ZyXELFD0000.speed

5 GHz Wireless Password (WPA2):

Your 5 GHz (11ac) wireless name will automatically have "speed" added to the end. Check "Edit 5 GHz wireless network" if you would like to edit it.

3 Apply Settings

Apply

! IMPORTANT!

Please write down all information that you've input here, so that you can refer to it in the future. When you're ready to apply this setup, click on "Apply"

ZyXEL Communications (C) 2015

The following table describes the labels in this screen.

Table 7 Wireless Network

LABEL	DESCRIPTION
Wireless Name (SSID)	Enter a descriptive name for the wireless LAN. Note: The setting here applies to 2.4 GHz wireless radios. If you change this field on the NBG6617, make sure all wireless stations use the same SSID in order to access the network.
Wireless Password (WPA2)	Type from 8 to 63 case-sensitive ASCII characters. You can set up the most secure wireless connection by configuring WPA in the wireless LAN screens.
Edit 5 GHz wireless network	Select this check box to configure different SSID and wireless security settings for the NBG6617's 5 GHz wireless network. If you do not select this option, the NBG6617 uses the same SSID and Wi-Fi key (you configured above) for the 5 GHz wireless network.
5GHz Wireless Name (SSID)	Enter a descriptive name for the wireless LAN. If you change this field on the NBG6617, make sure all wireless stations use the same SSID in order to access the network.
5GHz Wireless Password (WPA2)	Type from 8 to 63 case-sensitive ASCII characters. You can set up the most secure wireless connection by configuring WPA in the wireless LAN screens.

Click the **Apply** button in the third part to save your settings.

Figure 14 Apply your Wi-Fi settings

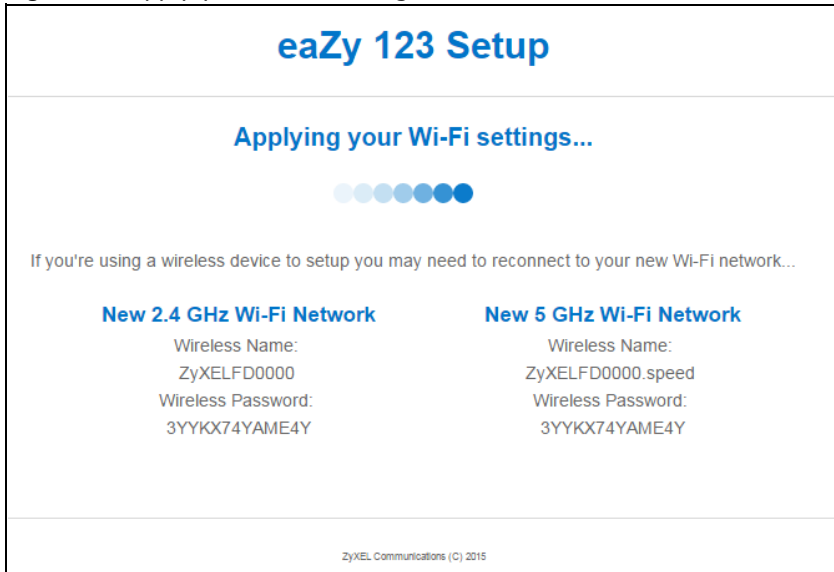

Congratulations! Open a web browser, such as Internet Explorer, to visit your favorite website.

Note: If you cannot access the Internet when your computer is connected to one of the NBG6617's LAN ports, check your connections. Then turn the NBG6617 off, wait for a few seconds then turn it back on. If that does not work, log in to the web configurator again and check you have typed all information correctly. See the User's Guide for more suggestions.

Figure 15 Congratulations

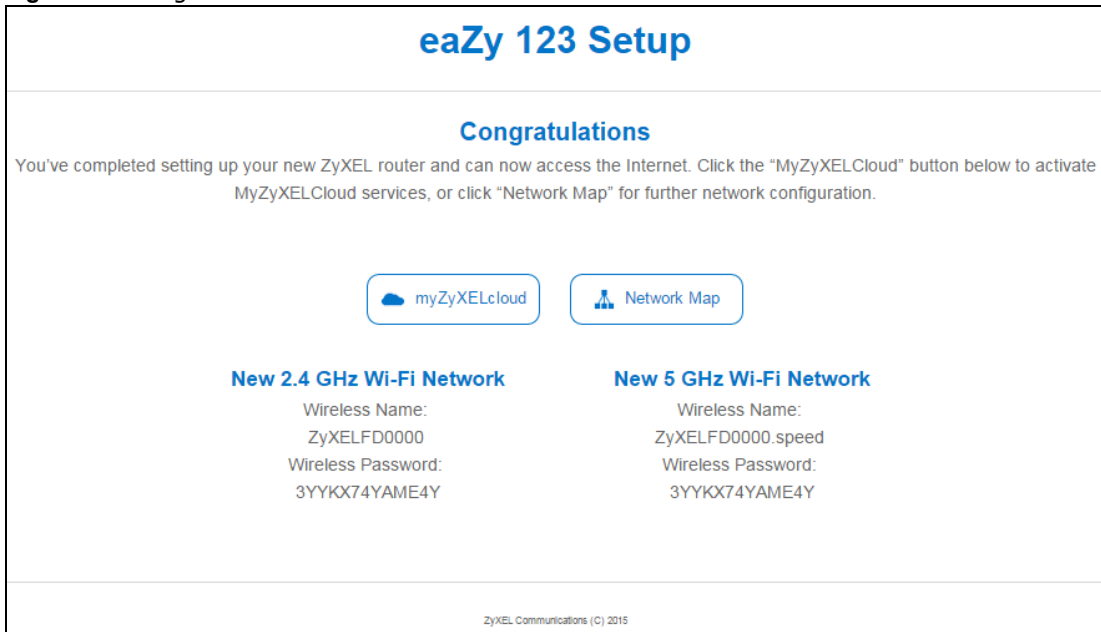

You can click the **My ZyXEL Cloud Service** button to go to <https://mycloud.zyxel.com>, where you can create an account and register your NBG6617. At the time of writing, you can have free DDNS

service to get a domain name mapped to the NBG6617's dynamic IP address. With DDNS, you can use the domain name to remotely access the NBG6617's Web Configurator through the Internet.

You have successfully set up your NBG6617 to operate on your network and access the Internet.

NBG6617 Modes

4.1 Overview

This chapter introduces the different modes available on your NBG6617. First, the term "mode" refers to two things in this User's Guide.

- **Web Configurator mode.** This refers to the Web Configurator interface you want to use for editing NBG6617 features.
- **Device mode.** This is the operating mode of your NBG6617, or simply how the NBG6617 is being used in the network.

4.1.1 Web Configurator Modes

This refers to the configuration interface of the Web Configurator, which has two modes:

- **Easy:** The Web Configurator shows this mode by default. Refer to [Chapter 5 on page 28](#) for more information on the screens in this mode. This interface may be sufficient for users who just want to use the device.
- **Expert:** Advanced users can change to this mode to customize all the functions of the NBG6617. Click > **Expert Mode** after logging into the Web Configurator. The User's Guide [Chapter 9 on page 60](#) through [Chapter 15 on page 147](#) discusses the screens in this mode.

4.1.2 Device Modes

This refers to the operating mode of the NBG6617, which can act as a:

- **Router:** This is the default device mode of the NBG6617. Use this mode to connect the local network to another network, like the Internet. Go to [Section 6.2 on page 36](#) to view the **Status** screen in this mode.
- **Access Point:** Use this mode if you want to extend your network by allowing network devices to connect to the NBG6617 wirelessly. Go to [Section 7.4 on page 44](#) to view the **Status** screen in this mode.

For more information on these modes and to change the mode of your NBG6617, refer to [Chapter 15 on page 147](#).

The menu for changing device modes is available in **Expert Mode** only.

Note: Choose your device mode carefully to avoid having to change it later.

When changing to another mode, the IP address of the NBG6617 changes. The running applications and services of the network devices connected to the NBG6617 can be interrupted.

Easy Mode

5.1 Overview

The Web Configurator is set to **Easy Mode** by default. You can configure several key features of the NBG6617 in this mode. This mode is useful to users who are not fully familiar with some features that are usually intended for network administrators.

When you log in to the Web Configurator, the following screen opens.

Figure 16 Easy Mode

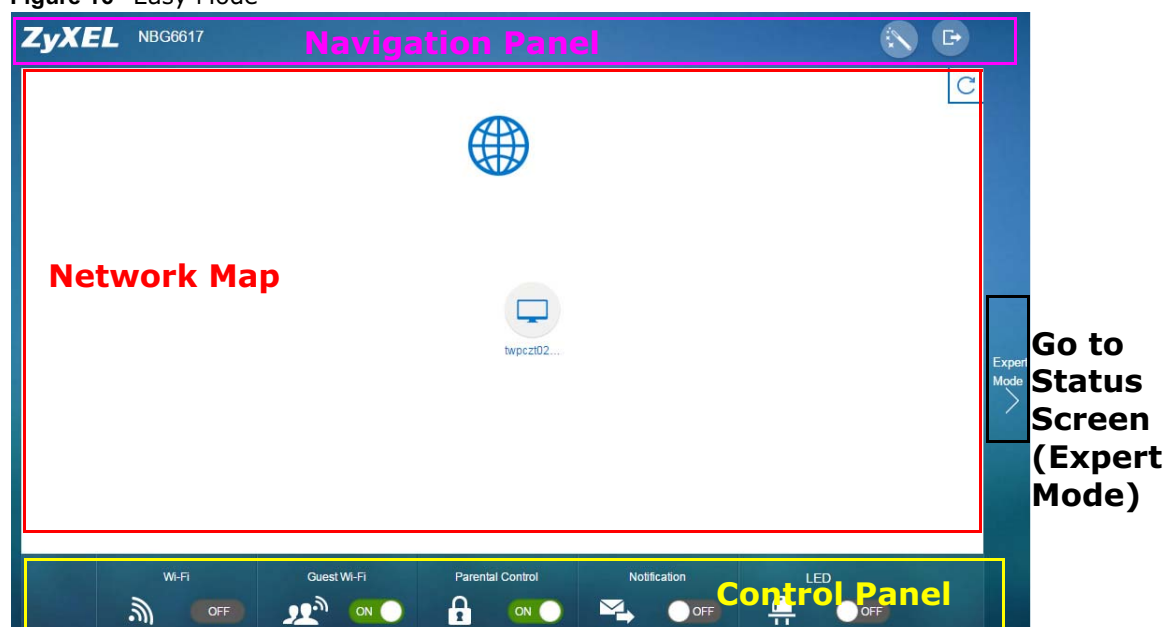

5.2 What You Can Do

You can do the following in this mode:

- Use this **Navigation Panel** to open the eaZy123 wizard or log out the NBG6617 ([Section 5.4 on page 29](#)).
- Use the **Network Map** screen to check if your NBG6617 is connected to the Internet ([Section 5.5 on page 29](#)).
- Use the **Control Panel** to configure and enable NBG6617 features, including guest Wi-Fi, wireless security, parental control and so on ([Section 5.6 on page 31](#)).

5.3 What You Need to Know

Between the different device modes, the **Control Panel** (Section 5.6 on page 31) changes depending on which features are applicable to the mode:

- **Router Mode:** All **Control Panel** features are available.
- **Access Point Mode:** **Parental Control** and **Notification** are not available.

5.4 Navigation Panel

Use this navigation panel to opt out of the **Easy** mode.

Figure 17 Easy Mode: Navigation Panel



The following table describes the labels in this screen.

Table 8 Easy Mode: Navigation Panel



ITEM	DESCRIPTION
 Firmware Notification	Click this icon to open a screen where you can click Check here to redirect your screen to the firmware upgrade page. This icon only displays when new firmware is released.
 Wizard	Click this icon to open the eaZy123 wizard for the NBG6617.
 Logout	Click this to end the Web Configurator session.

Figure 18 Easy Mode: Navigation Panel: Firmware Notification



5.5 Network Map

When you log into the Web Configurator, the Network Map is shown as follows.

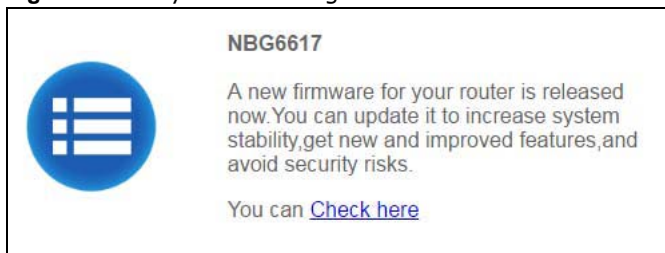
Figure 19 Easy Mode: Network Map

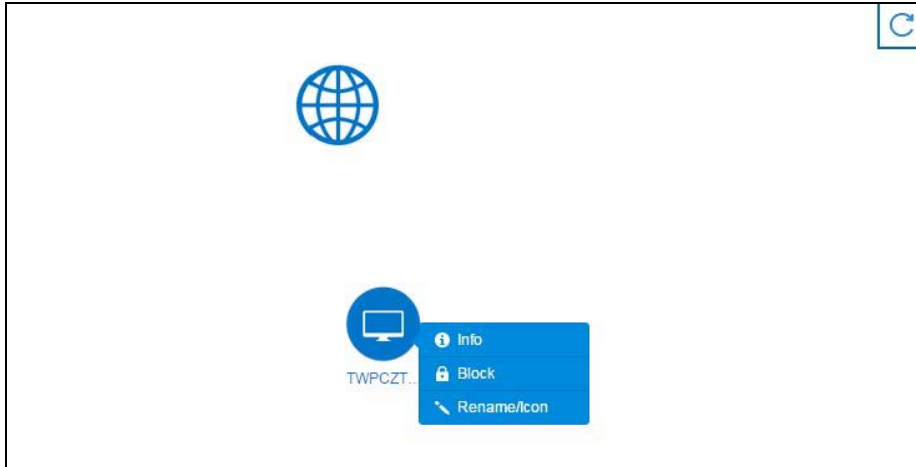

This screen displays whether the NBG6617 connects to the Internet. It also shows the devices connected to the NBG6617, including those connecting wirelessly. Click the **Refresh** button to refresh the network map.

The following table describes the icons in this screen.

Table 9 Easy Mode: Network Map





ITEM	DESCRIPTION
	This icon shows the NBG6617's connection status. This icon is grayed out if the user is unable to access the Internet.
	Click this button to refresh the NBG6617's connection status and the network map.
 Info	Click this to view the device's information that is currently connected to the NBG6617.
 Block	Click this to block the device from accessing the Internet through the NBG6617.
 Rename / Icon	Click this to rename the device or change the device's icon.

Figure 20 Easy Mode: Network Map: Info



Figure 21 Easy Mode: Network Map: Rename / Icon

Click **Apply** to save your changes back to the NBG6617. Click **Cancel** to reload the previous configuration for this screen.

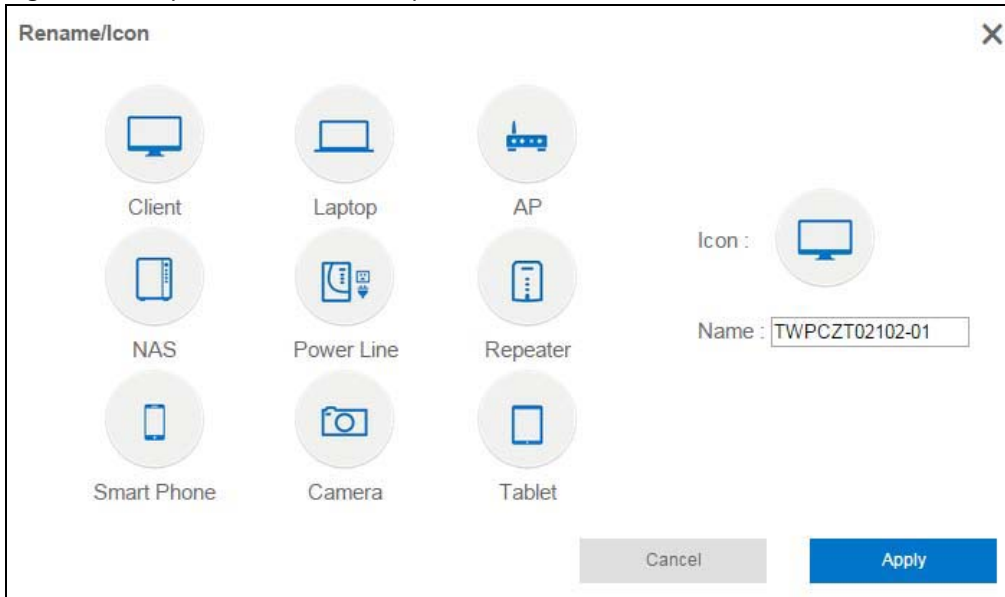
5.6 Control Panel

The features configurable in **Easy Mode** are shown in the **Control Panel**.

Figure 22 Easy Mode: Control Panel

Switch **ON** to enable the feature. Otherwise, switch **OFF**. If the feature is turned on, the green light flashes. If it is turned off, the blue light flashes.

Additionally, click the feature to open a screen where you can edit its settings.

The following table describes the labels in this screen.

Table 10 Easy Mode: Control Panel

ITEM	DESCRIPTION
Wi-Fi	Switch ON to enable the NBG6617's default Wi-Fi network, and click this to configure its wireless radio, SSID, security mode and wireless password. Refer to Section 5.6.1 on page 32 to see this screen.
Guest Wi-Fi	Switch ON to enable the guest Wi-Fi network, and click this to configure its wireless security settings.

Table 10 Easy Mode: Control Panel (continued)

ITEM	DESCRIPTION
Parental Control	Switch ON to enable parental control, and click this to view the parental control rules. Otherwise, switch OFF . Refer to Section 5.6.3 on page 34 to see this screen.
Notification	Switch ON to have the NBG6617 send e-mail notifications when the user(s) is connected to the NBG6617 for Internet access during the specified time periods. Otherwise, switch OFF . Refer to Section 5.6.4 on page 34 to see this screen.

5.6.1 Wi-Fi

Use this screen to configure security for the NBG6617's default wireless LAN. You can enter the SSID and select the wireless security mode in the following screen. See [Chapter 14 on page 129](#) for how to configure wireless network.

Note: You can enable the wireless function of your NBG6617 by first turning on the **WIFI** switch in the rear panel.

Figure 23 Easy Mode: Wi-Fi

The following table describes the labels in this screen.

Table 11 Easy Mode: Wi-Fi

LABEL	DESCRIPTION
Wireless Radio	Choose whether you want to apply the wireless security to 2.4G Hz , 5G Hz or Both wireless radios.
Network Name (SSID)	(Service Set IDentity) The SSID identifies the Service Set with which a wireless station is associated. Wireless stations associating to the access point (AP) must have the same SSID. Enter a descriptive name (up to 32 keyboard characters) for the wireless LAN.

Table 11 Easy Mode: Wi-Fi

LABEL	DESCRIPTION
Security Mode	Select WPA2-PSK to enable data encryption. Or Select No Security to allow wireless clients to communicate with the access points without any data encryption.
Password	This field appears when you choose WPA2-PSK as the security mode. Type a pre-shared key from 8 to 63 case-sensitive keyboard characters.
Verify Password	Type the password again to confirm.
Cancel	Click Cancel to reload the previous configuration for this screen.
Apply	Click Apply to save your changes back to the NBG6617.

5.6.2 Guest Wi-Fi

This screen allows you to configure guest wireless network settings on the NBG6617. Users connected to the guest wireless network can access the Internet via the NBG6617, but not other networks connected to the NBG6617. See [Chapter 11 on page 80](#) for how to enable and set up the guest wireless network.

Figure 24 Easy Mode: Guest Wi-Fi

The following table describes the labels in this screen.

Table 12 Easy Mode: Guest Wi-Fi

LABEL	DESCRIPTION
Wireless Radio	Choose whether you want to apply the wireless settings to the 2.4G Hz or 5G Hz wireless radio.
Network Name (SSID)	The SSID (Service Set IDentity) identifies the Service Set with which a wireless client is associated. Enter a descriptive name (up to 32 printable characters found on a typical English language keyboard) for the guest wireless network.
Security Mode	Select WPA2-PSK to enable data encryption. Or select No Security to allow wireless clients to communicate with the NBG6617 without any data encryption.

Table 12 Easy Mode: Guest Wi-Fi

LABEL	DESCRIPTION
Password	This field appears when you choose WPA2-PSK as the security mode. Type a pre-shared key from 8 to 63 case-sensitive keyboard characters.
Verify Password	Type the password again to confirm.
Cancel	Click Cancel to reload the previous configuration for this screen.
Apply	Click Apply to save your changes back to the NBG6617.

5.6.3 Parental Control

Use this screen to view the parental control rules configured on the NBG6617. See [Section 13.2 on page 106](#) for how to enable and configure parental control rules.

Figure 25 Easy Mode: Parental Control

Status	User Name	Schedule	Bonus	Remaining time
	Test	Block	<input type="button" value="Bonus"/>	16:4:39
	example	Allow	<input type="button" value="Bonus"/>	None

The following table describes the labels in this screen.

Table 13 Easy Mode: Parental Control

LABEL	DESCRIPTION
Status	This indicates whether the rule is active or not. A yellow bulb signifies that this rule is active. A gray bulb signifies that this rule is not active.
User Name	This shows the name of the user to which this rule applies.
Schedule	This shows whether the user is allowed to access the Internet (Allow) or not (Block).
Bonus	If the user is currently not permitted to access the Internet, you can click the Bonus to allow access for a specified period of time. A screen then displays allowing you to set how long (in minutes) the user is allowed to access the Internet. This button is grayed out if the user is now able to access the Internet.
Remaining time	This field displays the amount of Internet access time that remains for each user before the NBG6617 blocks the user from accessing the Internet. None means there is no extra Internet access time.

5.6.4 Notification

Use this screen to view the e-mail notification rules configured on the NBG6617. See [Section 13.2.2 on page 110](#) for how to configure e-mail notification rules and e-mail settings.

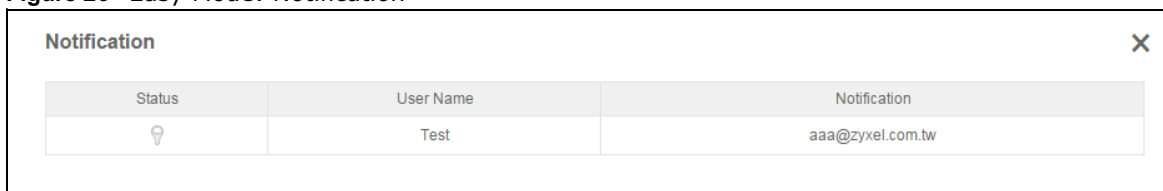
Figure 26 Easy Mode: Notification

Status	User Name	Notification
⚪	Test	aaa@zyxel.com.tw

The following table describes the labels in this screen.

Table 14 Easy Mode: Notification

LABEL	DESCRIPTION
Notification	
Status	This indicates whether the rule is active or not. A yellow bulb signifies that this rule is active. A gray bulb signifies that this rule is not active.
User Name	This shows the name of the user to which this rule applies.
Notification	This shows the e-mail address to which the notification is sent.

Router Mode

6.1 Overview

The NBG6617 is set to router mode by default. Routers are used to connect the local network to another network (for example, the Internet). In the figure below, the NBG6617 connects the local network (**LAN1 ~ LAN4**) to the Internet.

Figure 27 NBG6617 Network

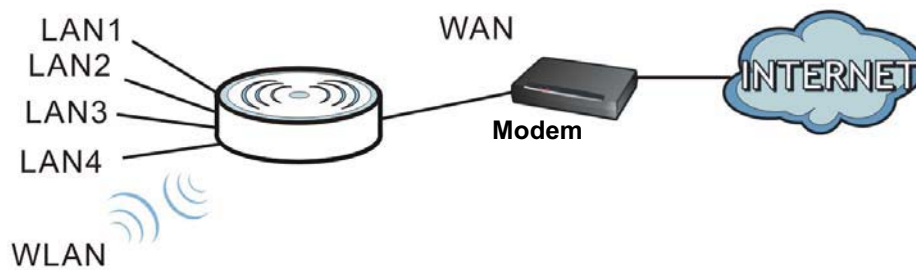



Note: After clicking **Login**, the **Easy Mode** appears. Refer to [Chapter 5 on page 28](#) for the **Easy Mode** screens. Change to **Expert Mode** to see the screens described in the sections following this.

6.2 Router Mode Status Screen

Click **Expert Mode** > **Status** > **System Status** to open the status screen.

Figure 28 Expert Mode: Status > System Status: Router Mode

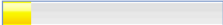
Device Information	
Item	Data
Host Name:	NBG6617
Model Number:	NBG6617
Firmware Version:	V1.00(ABCT.0)b2
Sys OP Mode:	Router Mode
WAN Information	
- MAC Address:	66:AA:BB:CC:DD:63
- IP Address:	
- IP Subnet Mask:	
- Default Gateway:	
- IPv6 Address:	
LAN Information:	
- MAC Address:	66:AA:BB:CC:DD:62
- IP Address:	192.168.1.1
- IP Subnet Mask:	255.255.255.0
- DHCP:	Server
- IPv6 Address:	
WLAN 2.4G Information:	
- WLAN OP Mode:	Access Point Mode
- MAC Address:	66:AA:BB:CC:DD:60
- SSID:	ZyXELCCDD62
- Channel:	6
- Security:	WPA2-PSK
WLAN 5G Information:	
- WLAN OP Mode:	Access Point Mode
- MAC Address:	66:AA:BB:CC:DD:61
- SSID:	ZyXELCCDD62.speed
- Channel:	108
- Security:	WPA2-PSK
Firewall:	Enable

System Status	
Item	Data
System Up Time:	0day 2hr 0min 55sec
Current Date/Time:	2016-05-18/14:02:01
System Resource:	
- CPU Usage:	 9%
- Memory Usage:	 53%

Interface Status		
Interface	Status	Rate
WAN	Down	
LAN1	Down	
LAN2	Down	
LAN3	Down	
LAN4	Down	
WLAN 2.4G	UP	400 M
WLAN 5G	UP	866 M

Printer Information	
Item	Data
Printer Name:	None

The following table describes the labels shown in the **Status** screen.

Table 15 Expert Mode: Status > System Status: Router Mode

LABEL	DESCRIPTION
Device Information	
Item	This column shows the type of data the NBG6617 is recording.
Data	This column shows the actual data recorded by the NBG6617.
Host Name	This is the System Name you enter in the Maintenance > General screen. It is for identification purposes.
Model Number	This is the model name of your device.
Firmware Version	This is the firmware version.
Sys OP Mode	This is the device mode (Section 4.1.2 on page 27) to which the NBG6617 is set - Router Mode .
WAN Information	
MAC Address	This shows the WAN Ethernet adapter MAC Address of your device.
IP Address	This shows the WAN port's IP address.
IP Subnet Mask	This shows the WAN port's subnet mask.
Default Gateway	This shows the WAN port's gateway IP address.
IPv6 Address	This shows the IPv6 address of the NBG6617 on the WAN.
LAN Information	
MAC Address	This shows the LAN Ethernet adapter MAC Address of your device.

Table 15 Expert Mode: Status > System Status: Router Mode (continued)

LABEL	DESCRIPTION
IP Address	This shows the LAN port's IP address.
IP Subnet Mask	This shows the LAN port's subnet mask.
DHCP	This shows the LAN port's DHCP role - Server or Disable .
IPv6 Address	This shows the IPv6 address of the NBG6617 on the LAN.
WLAN 2.4G Information	
WLAN OP Mode	This is the device mode (Section 4.1.2 on page 27) to which the NBG6617's wireless LAN is set - Access Point Mode .
MAC Address	This shows the 2.4GHz wireless adapter MAC Address of your device.
SSID	This shows a descriptive name used to identify the NBG6617 in the 2.4GHz wireless LAN.
Channel	This shows the channel number which you select manually.
Security	This shows the level of wireless security the NBG6617 is using.
WLAN 5G Information	
WLAN OP Mode	This is the device mode (Section 4.1.2 on page 27) to which the NBG6617's wireless LAN is set - Access Point Mode .
MAC Address	This shows the 5GHz wireless adapter MAC Address of your device.
SSID	This shows a descriptive name used to identify the NBG6617 in the 5GHz wireless LAN.
Channel	This shows the channel number which you select manually.
Security	This shows the level of wireless security the NBG6617 is using.
Firewall	This shows whether the firewall is enabled or not.
System Status	
System Up Time	This is the total time the NBG6617 has been on.
Current Date/Time	This field displays your NBG6617's present date and time.
System Resource	
- CPU Usage	This displays what percentage of the NBG6617's processing ability is currently used. When this percentage is close to 100%, the NBG6617 is running at full load, and the throughput is not going to improve anymore. If you want some applications to have more throughput, you should turn off other applications (for example, using bandwidth management.)
- Memory Usage	This shows what percentage of the heap memory the NBG6617 is using.
Interface Status	
Interface	This displays the NBG6617 port types. The port types are: WAN , LAN and WLAN .
Status	For the LAN and WAN ports, this field displays Down (line is down) or Up (line is up or connected). For the 2.4GHz/5GHz WLAN, it displays Up when the 2.4GHz/5GHz WLAN is enabled or Down when the 2.4G/5G WLAN is disabled.
Rate	For the LAN ports, this displays the port speed and duplex setting or is left blank when the line is disconnected. For the WAN port, it displays the port speed and duplex setting if you're using Ethernet encapsulation. This field displays N/A when the line is disconnected. For the 2.4GHz/5GHz WLAN, it displays the maximum transmission rate when the 2.4GHz/5GHz WLAN is enabled and N/A when the WLAN is disabled.

Table 15 Expert Mode: Status > System Status: Router Mode (continued)

LABEL	DESCRIPTION
Printer Information	
Printer Name	The NBG6617 can act as a print server and allows you to share a USB printer on your LAN. This displays the name of the printer connected to the NBG6617's USB port. Note: You need to manually install the printer driver in your computer and add the printer to your printer list.

6.2.1 Navigation Panel

Use the sub-menus on the navigation panel to configure NBG6617 features.

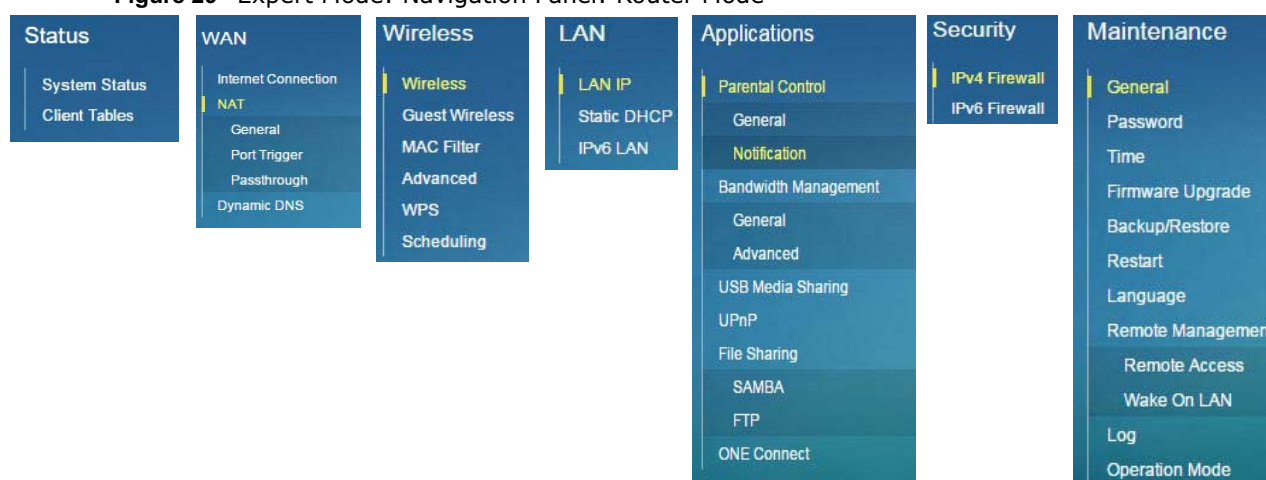
Figure 29 Expert Mode: Navigation Panel: Router Mode

The following table describes the sub-menus.

Table 16 Expert Mode: Navigation Panel: Router Mode

LINK	TAB	FUNCTION
Status		
System Status		This screen shows the NBG6617's general device, system and interface status information. Use this screen to access the wizard, and summary statistics tables.
Client Tables		Use this screen to view current DHCP client information.
WAN		
Internet Connection		This screen allows you to configure ISP parameters, WAN IP address assignment, DNS servers and the WAN MAC address.
NAT	General	Use this screen to enable NAT. Use this screen to configure servers behind the NBG6617 and forward incoming service requests to the server(s) on your local network.
	Port Trigger	Use this screen to change your NBG6617's port triggering settings.
	Passthrough	Use this screen to enable ALGs (Application Layer Gateway) and VPN pass-through settings.
Dynamic DNS		Use this screen to set up dynamic DNS.
Wireless		

Table 16 Expert Mode: Navigation Panel: Router Mode (continued)

LINK	TAB	FUNCTION
Wireless		Use this screen to enable the wireless LAN and configure wireless LAN and wireless security settings.
Guest Wireless		Use this screen to configure multiple BSSs on the NBG6617.
MAC Filter		Use the MAC filter screen to configure the NBG6617 to block access to devices or block the devices from accessing the NBG6617.
Advanced		This screen allows you to configure advanced wireless settings.
WPS		Use this screen to configure WPS.
Scheduling		Use this screen to schedule the times the Wireless LAN is enabled.
LAN		
LAN IP		Use this screen to configure LAN IP address and subnet mask. Use this screen to configure the IPv6 address for the NBG6617 on the LAN. Use this screen to enable the NBG6617's DHCP server.
Static DHCP		This screen allows you to assign IP addresses on the LAN to specific individual computers based on their MAC addresses.
IPv6 LAN		Use this screen to configure the IPv6 address for your NBG6617 on the LAN.
Applications		
Parental Control	General	Use this screen to enable parental control, set parental controls rules/schedules and block web sites containing certain keywords in the URL.
	Notification	Use this screen to send e-mail notifications, configure e-mail notification rules and e-mail settings.
Bandwidth Management	General	Use this screen to enable StreamBoost.
	Advanced	Use this screen to configure the maximum allowable bandwidth and enable automatic update. Use this screen to change the priority of the connected devices.
USB Media Sharing		Use this screen to have the NBG6617 function as a DLNA-compliant media server, that lets DLNA-compliant media clients play video, audio, and photo content files stored on the connected USB storage device.
UPnP		Use this screen to enable UPnP on the NBG6617.
File Sharing	SAMBA	Use this screen to enable file sharing through the NBG6617.
	FTP	Use this screen to have the NBG6617 act as a FTP server.
One Connect		Use this screen to enable or disable Wi-Fi auto-configuration.
Security		
IPv4 Firewall		Use this screen to configure IPv4 firewall rules.
IPv6 Firewall		Use this screen to configure IPv6 firewall rules.
Maintenance		
General		Use this screen to view and change administrative settings such as system and domain names.
Password		Use this screen to change the password of your NBG6617.
Time		Use this screen to change your NBG6617's time and date.
Firmware Upgrade		Use this screen to upload firmware to your NBG6617.
Backup/Restore		Use this screen to backup and restore the configuration or reset the factory defaults to your NBG6617.

Table 16 Expert Mode: Navigation Panel: Router Mode (continued)

LINK	TAB	FUNCTION
Restart		This screen allows you to reboot the NBG6617 without turning the power off.
Language		This screen allows you to select the language you prefer.
Remote Management	Remote Access	Use this screen to configure through which interface(s) and from which IP address(es) users can use Telnet and HTTP/HTTPS to manage the NBG6617.
	Wake On LAN	Use this screen to enable Wake on LAN to remotely turn on a device on the local network.
Log		Use this screen to view the list of activities recorded by your NBG6617.
Operation Mode		This screen allows you to select whether your device acts as a router, or an access point.

Access Point Mode

7.1 Overview

Use your NBG6617 as an access point (AP) if you already have a router or gateway on your network. In this mode your NBG6617 bridges a wired network (LAN) and wireless LAN (WLAN) in the same subnet. See the figure below for an example.

Figure 30 Wireless Internet Access in Access Point Mode

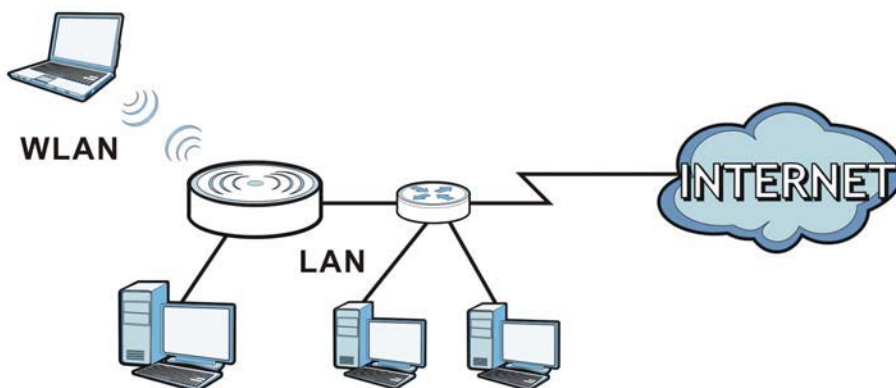

Many screens that are available in **Router Mode** are not available in **Access Point Mode**, such as bandwidth management and firewall.

7.2 What You Can Do

- Use the **Status** screen to view read-only information about your NBG6617 ([Section 7.4 on page 44](#)).
- Use the **LAN** screen to set the IP address for your NBG6617 acting as an access point ([Section 7.5 on page 46](#)).

7.3 What You Need to Know

See [Chapter 8 on page 49](#) for a tutorial on setting up a network with the NBG6617 as an access point.

7.3.1 Setting your NBG6617 to AP Mode

- 1 Log into the Web Configurator if you haven't already. See the Quick start Guide for instructions on how to do this.
- 2 To use your NBG6617 as an access point, go to **Expert Mode > Maintenance > Operation Mode** and select **Access Point Mode**.

Figure 31 Changing to Access Point mode

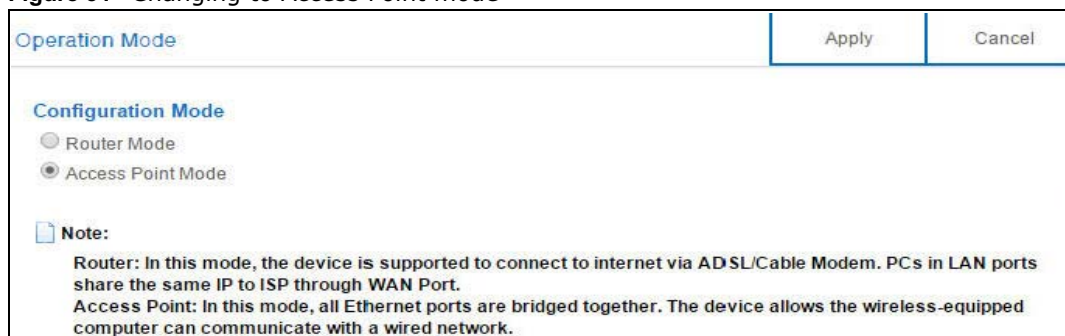

Note: You have to log in to the Web Configurator again when you change modes. As soon as you do, your NBG6617 is already in Access Point mode.

- 3 When you select **Access Point Mode**, the following pop-up message window appears.

Figure 32 Pop up for Access Point mode

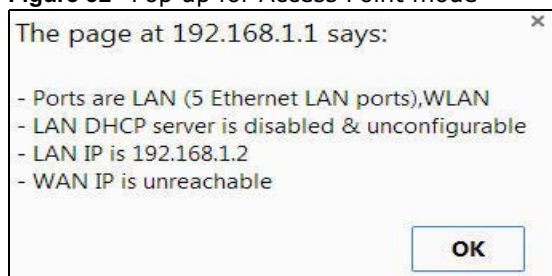

Click **OK**. Then click **Apply**. The Web Configurator refreshes once the change to Access Point mode is successful.

7.3.2 Accessing the Web Configurator in Access Point Mode

Log in to the Web Configurator in Access Point mode, do the following:

- 1 Connect your computer to the LAN port of the NBG6617.
- 2 The default IP address of the NBG6617 is "192.168.1.2". In this case, your computer must have an IP address in the range between "192.168.1.3" and "192.168.1.254".
- 3 Click **Start > Run** on your computer in Windows. Type "cmd" in the dialog box. Enter "ipconfig" to show your computer's IP address. If your computer's IP address is not in the correct range then see [Appendix B on page 162](#) for information on changing your computer's IP address.

- 4 After you've set your computer's IP address, open a web browser such as Internet Explorer and type "192.168.1.2" as the web address in your web browser.

Note: After clicking **Login**, the **Easy Mode** appears. Refer to [Chapter 5 on page 28](#) for the **Easy Mode** screens. Change to **Expert Mode** to see the screens described in the sections following this.

7.3.3 Configuring your WLAN and Maintenance Settings

The configuration of wireless and maintenance settings in **Access Point Mode** is the same as for **Router Mode**.

- See [Chapter 11 on page 80](#) for information on the configuring your wireless network.
- See [Chapter 15 on page 135](#) for information on configuring your maintenance settings.

7.4 AP Mode Status Screen

Click **Expert Mode > Status** to open the **Status** screen.

Figure 33 Expert Mode: Status > System Status: Access Point Mode

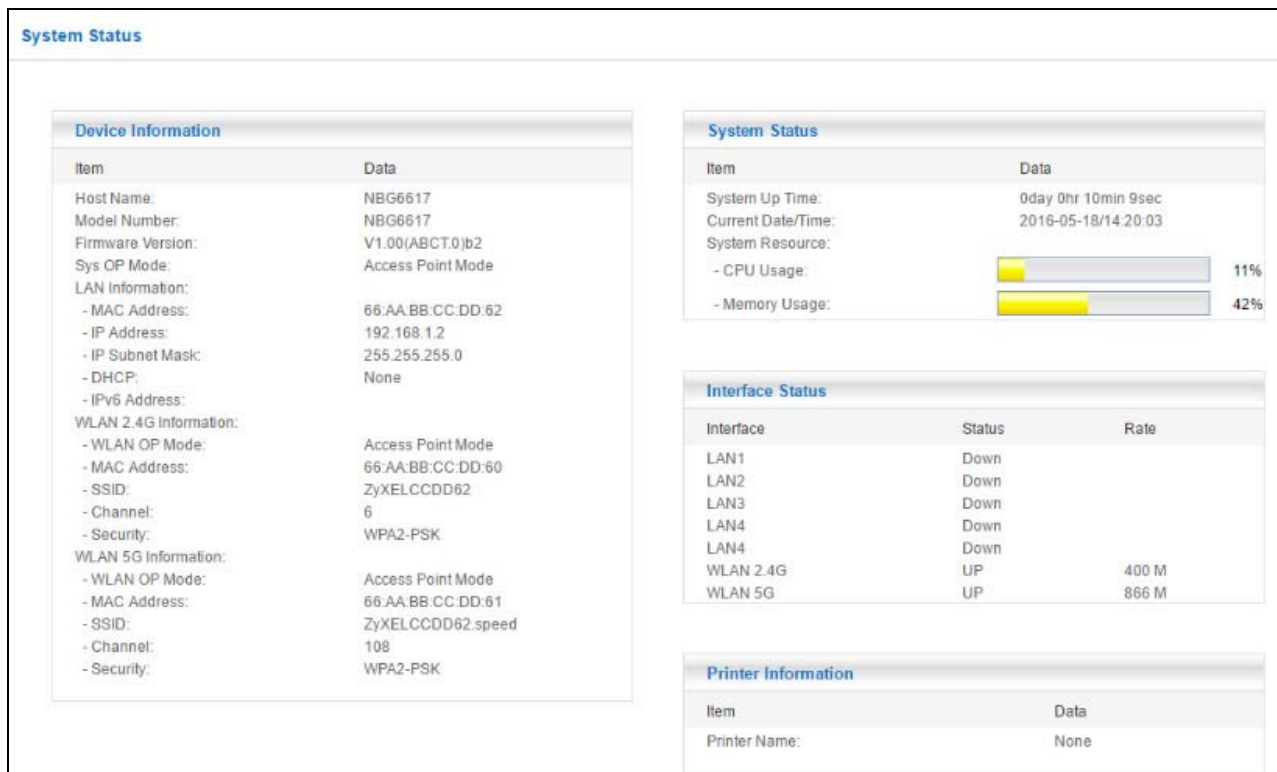

The following table describes the labels shown in the **Status** screen.

Table 17 Expert Mode: Status > System Status: Access Point Mode

LABEL	DESCRIPTION
Device Information	
Host Name	This is the System Name you enter in the Maintenance > General screen. It is for identification purposes.
Model Number	This is the model name of your device.
Firmware Version	This is the firmware version and the date created.
Sys OP Mode	This is the device mode (Section 4.1.2 on page 27) to which the NBG6617 is set - AP Mode .
LAN Information	
MAC Address	This shows the LAN Ethernet adapter MAC Address of your device.
IP Address	This shows the LAN port's IP address.
IP Subnet Mask	This shows the LAN port's subnet mask.
DHCP	This shows the LAN port's DHCP role - Client or None .
IPv6 Address	This shows the IPv6 address of the NBG6617 on the LAN.
WLAN 2.4G Information	
WLAN OP Mode	This is the device mode (Section 4.1.2 on page 27) to which the NBG6617's wireless LAN is set - Access Point Mode .
MAC Address	This shows the 2.4GHz wireless adapter MAC Address of your device.
SSID	This shows a descriptive name used to identify the NBG6617 in the 2.4GHz wireless LAN.
Channel	This shows the channel number which you select manually.
Security	This shows the level of wireless security the NBG6617 is using.
WLAN 5G Information	
WLAN OP Mode	This is the device mode (Section 4.1.2 on page 27) to which the NBG6617's wireless LAN is set - Access Point Mode .
MAC Address	This shows the 5GHz wireless adapter MAC Address of your device.
SSID	This shows a descriptive name used to identify the NBG6617 in the 5GHz wireless LAN.
Channel	This shows the channel number which you select manually.
Security	This shows the level of wireless security the NBG6617 is using.
System Status	
Item	This column shows the type of data the NBG6617 is recording.
Data	This column shows the actual data recorded by the NBG6617.
System Up Time	This is the total time the NBG6617 has been on.
Current Date/Time	This field displays your NBG6617's present date and time.
System Resource	
- CPU Usage	This displays what percentage of the NBG6617's processing ability is currently used. When this percentage is close to 100%, the NBG6617 is running at full load, and the throughput is not going to improve anymore. If you want some applications to have more throughput, you should turn off other applications (for example, using bandwidth management.)
- Memory Usage	This shows what percentage of the heap memory the NBG6617 is using.
Interface Status	
Interface	This displays the NBG6617 port types. The port types are: LAN and WLAN .
Status	For the LAN ports, this field displays Down (line is down) or Up (line is up or connected). For the 2.4GHz/5GHz WLAN, it displays Up when the 2.4GHz/5GHz WLAN is enabled or Down when the 2.4G/5G WLAN is disabled.

Table 17 Expert Mode: Status > System Status: Access Point Mode (continued)

LABEL	DESCRIPTION
Rate	For the LAN ports, this displays the port speed and duplex setting or is left blank when the line is disconnected. For the 2.4GHz/5GHz WLAN, it displays the maximum transmission rate when the 2.4GHz/5GHz WLAN is enabled and N/A when the WLAN is disabled.
Printer Information	
Printer Name	The NBG6617 can act as a print server and allows you to share a USB printer on your LAN. This displays the name of the printer connected to the NBG6617's USB port. Note: You need to manually install the printer driver in your computer and add the printer to your printer list.

7.4.1 Navigation Panel

Use the menu in the navigation panel to configure NBG6617 features in **Access Point Mode**.

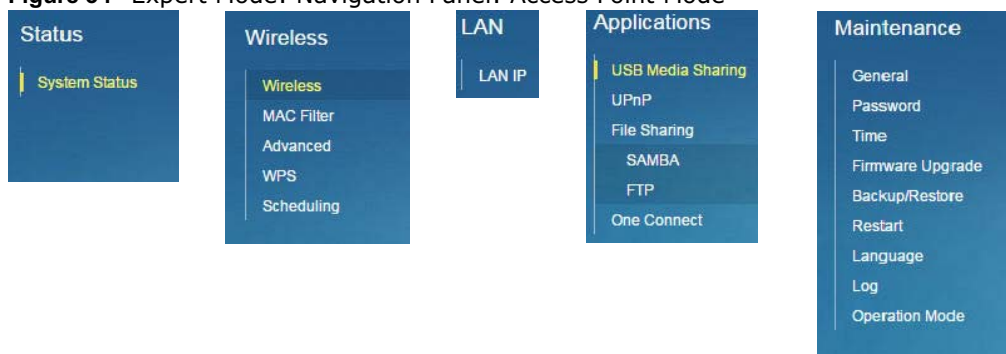
Figure 34 Expert Mode: Navigation Panel: Access Point Mode

Refer to [Table 16 on page 39](#) for descriptions of the labels shown in the navigation panel.

7.5 LAN Screen

Use this section to configure your LAN settings while in **Access Point Mode**.

Click **Expert Mode > LAN** to see the screen below.

Note: If you change the IP address of the NBG6617 in the screen below, you will need to log into the NBG6617 again using the new IP address.

Figure 35 LAN > LAN IP

The table below describes the labels in the screen.

Table 18 LAN > LAN IP

LABEL	DESCRIPTION
IP Address	
Obtain an IP Address Automatically	When you enable this, the NBG6617 gets its IP address from the network's DHCP server (for example, your ISP). Users connected to the NBG6617 can now access the network (i.e., the Internet if the IP address is given by the ISP). The Web Configurator may no longer be accessible unless you know the IP address assigned by the DHCP server to the NBG6617. You need to reset the NBG6617 to be able to access the Web Configurator again (see Section 15.7 on page 140 for details on how to reset the NBG6617). Also when you select this, you cannot enter an IP address for your NBG6617 in the field below.
Static IP Address	Click this if you want to specify the IP address of your NBG6617. Or if your ISP or network administrator gave you a static IP address to access the network or the Internet.
IP Address	Type the IP address in dotted decimal notation. The default setting is 192.168.1.2. If you change the IP address you will have to log in again with the new IP address.
Subnet Mask	The subnet mask specifies the network number portion of an IP address. Your NBG6617 will automatically calculate the subnet mask based on the IP address that you assign. Unless you are implementing subnetting, use the subnet mask computed by the NBG6617.
Default Gateway	Enter a Default Gateway's IP address (if your ISP or network administrator gave you one) in this field.
DNS Server	
First DNS Server Second DNS Server Third DNS Server	Select Obtained From ISP if your ISP dynamically assigns DNS server information (and the NBG6617's WAN IP address). The field to the right displays the (read-only) DNS server IP address that the ISP assigns. Select User-Defined if you have the IP address of a DNS server. Enter the DNS server's IP address in the field to the right. If you chose User-Defined , but leave the IP address set to 0.0.0.0, User-Defined changes to None after you click Apply . If you set a second choice to User-Defined , and enter the same IP address, the second User-Defined changes to None after you click Apply . Select None if you do not want to configure DNS servers. If you do not configure a DNS server, you must know the IP address of a computer in order to access it.

Table 18 LAN > LAN IP (continued)

LABEL	DESCRIPTION
Apply	Click Apply to save your changes to the NBG6617.
Cancel	Click Cancel to reload the previous configuration for this screen.

8.1 Overview

This chapter provides tutorials for setting up your NBG6617.

- [Set Up a Wireless Network Using WPS](#)
- [Connect to NBG6617 Wireless Network without WPS](#)
- [Using Guest SSIDs on the NBG6617](#)

8.2 Set Up a Wireless Network Using WPS

This section gives you an example of how to set up wireless network using WPS. This example uses the NBG6617 as the AP and NWD210N as the wireless client which connects to a notebook.

Note: The wireless client must be a WPS-aware device (for example, a WPS USB adapter or PCI card).

There are two WPS methods for creating a secure connection via the web configurator or utility. This tutorial shows you how to do both.

- **Push Button Configuration (PBC)** - create a secure wireless network simply by pressing a button. See [Section 8.2.1 on page 49](#). This is the easier method.
- **PIN Configuration** - create a secure wireless network simply by entering a wireless client's PIN (Personal Identification Number) in the NBG6617's interface. See [Section 8.2.2 on page 50](#). This is the more secure method, since one device can authenticate the other.

8.2.1 Push Button Configuration (PBC)

- 1 Make sure that your NBG6617 is turned on. Make sure the **WIFI** button (at the rear panel of the NBG6617) is pushed in, and that the device is placed within range of your notebook.
- 2 Make sure that you have installed the wireless client (this example uses the NWD210N) driver and utility in your notebook.
- 3 In the wireless client utility, find the WPS settings. Enable WPS and press the WPS button (**Start** or **WPS** button)
- 4 Log into NBG6617's Web Configurator and press the **Push Button** in the **Expert > Wireless > WPS** screen.

Note: Your NBG6617 has a WPS button located on its top panel, as well as a WPS button in its configuration utility. Both buttons have exactly the same function; you can use one or the other.

Note: It doesn't matter which button is pressed first. You must press the second button within two minutes of pressing the first one.

The NBG6617 sends the proper configuration settings to the wireless client. This may take up to two minutes. Then the wireless client is able to communicate with the NBG6617 securely.

The following figure shows you an example to set up wireless network and security by pressing a button on both NBG6617 and wireless client (the NWD210N in this example).

Figure 36 Example WPS Process: PBC Method

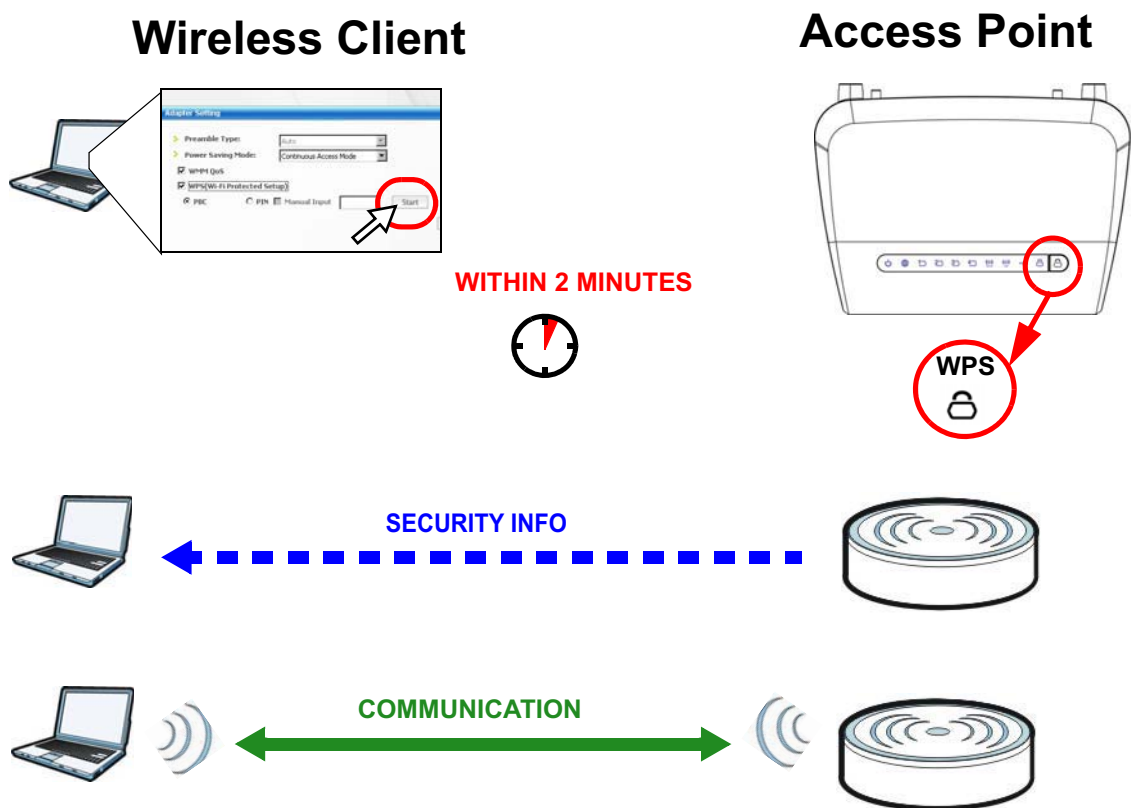

8.2.2 PIN Configuration

When you use the PIN configuration method, you need to use both NBG6617's configuration interface and the client's utilities.

- 1 Launch your wireless client's configuration utility. Go to the WPS settings and select the PIN method to get a PIN number.
- 2 Enter the PIN number to the **PIN** field in the **Expert > Wireless > WPS** screen on the NBG6617.

- 3 Click **Start** buttons (or button next to the PIN field) on both the wireless client utility screen and the NBG6617's **WPS** screen within two minutes.

The NBG6617 authenticates the wireless client and sends the proper configuration settings to the wireless client. This may take up to two minutes. Then the wireless client is able to communicate with the NBG6617 securely.

The following figure shows you the example to set up wireless network and security on NBG6617 and wireless client (ex. NWD210N in this example) by using PIN method.

Figure 37 Example WPS Process: PIN Method

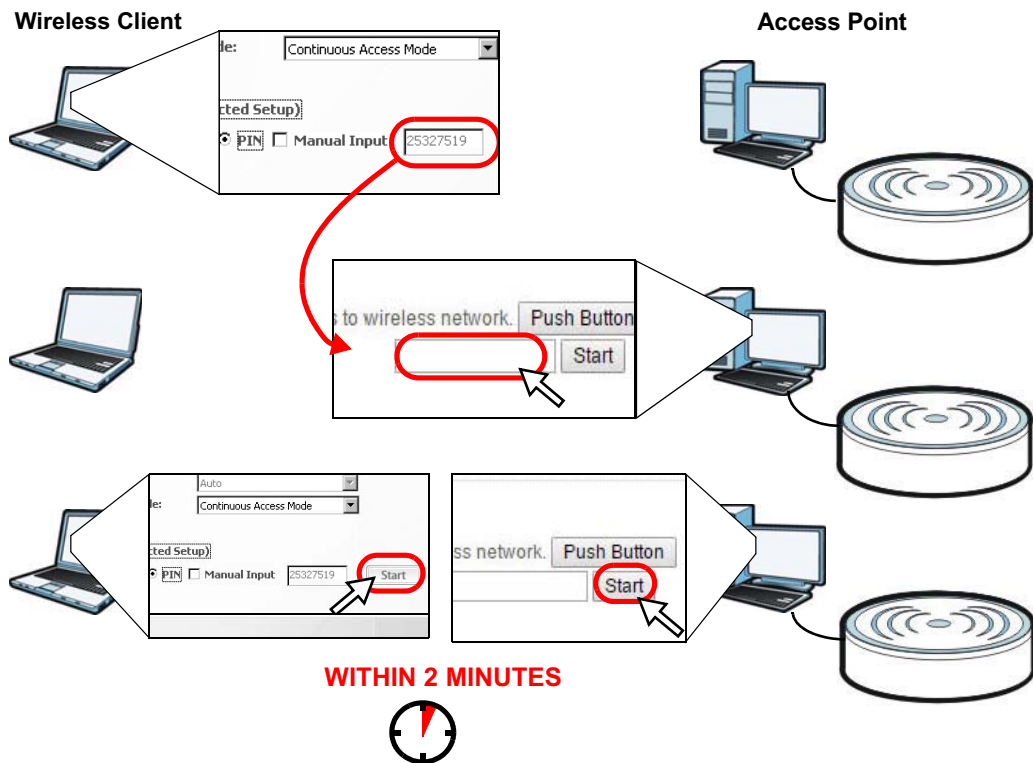

8.3 Connect to NBG6617 Wireless Network without WPS

This example shows you how to configure wireless security settings with the following parameters on your NBG6617 and connect your computer to the NBG6617 wireless network.

Band	2.4GHz
SSID	SSID_Example3
Channel	6
Security	WPA2-PSK (Pre-Shared Key: ThisismyWPA-PSKpre-sharedkey)

Follow the steps below to configure the wireless settings on your NBG6617.

The instructions require that your hardware is connected (see the Quick Start Guide) and you are logged into the Web Configurator through your LAN connection (see [Section 2.2 on page 15](#)).

- 1 Make sure the **WIFI** switch (at the rear panel of the NBG6617) is set to **ON**.
- 2 Open the **Expert > Wireless > Wireless** screen in the AP's Web Configurator.
- 3 Confirm that the wireless LAN is enabled on the NBG6617.
- 4 Select to configure the wireless settings for the 2.4GHz wireless radio.
- 5 Enter **SSID_Example3** as the SSID and select **Channel-06** as the channel. Set security mode to **WPA2-PSK** and enter **ThisismyWPA-PSKpre-sharedkey** in the **Pre-Shared Key** field. Click **Apply**.

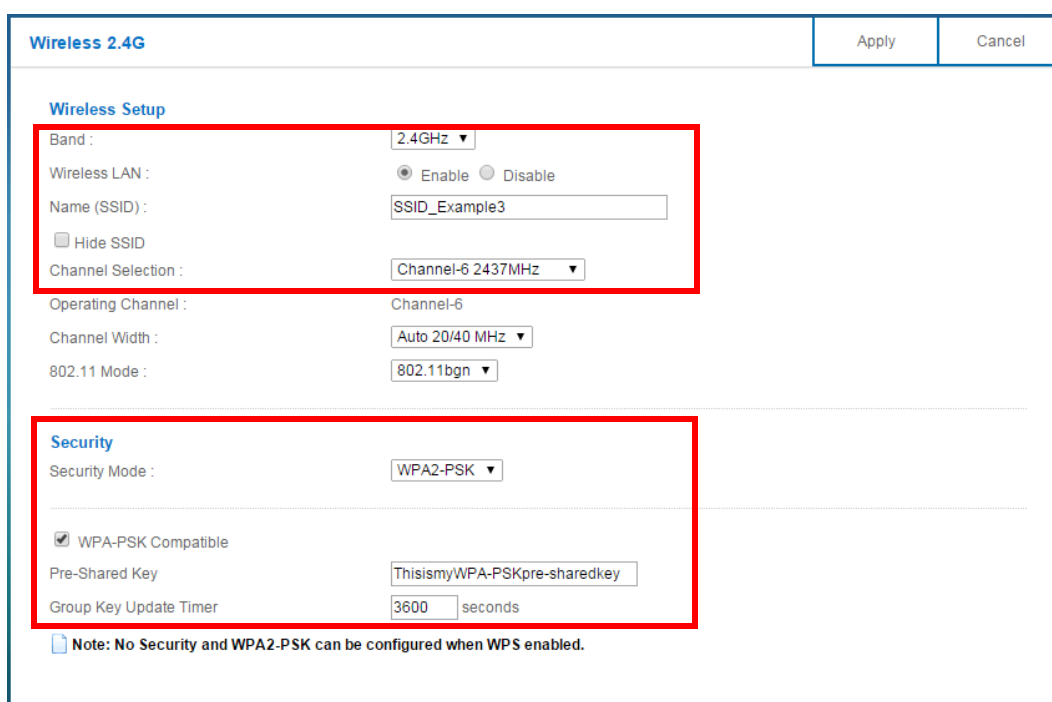

Wireless 2.4G Apply Cancel

Wireless Setup

Band : 2.4GHz ▼

Wireless LAN : Enable Disable

Name (SSID) : SSID_Example3

Hide SSID

Channel Selection : Channel-6 2437MHz ▼

Operating Channel : Channel-6

Channel Width : Auto 20/40 MHz ▼

802.11 Mode : 802.11bgn ▼

Security

Security Mode : WPA2-PSK ▼

WPA-PSK Compatible

Pre-Shared Key : ThisismyWPA-PSKpre-sharedkey

Group Key Update Timer : 3600 seconds

Note: No Security and WPA2-PSK can be configured when WPS enabled.

- 6 Click **Expert > Status** to open the **Status** screen. Verify your wireless and wireless security settings under **Device Information** and check if the WLAN connection is up under **Interface Status**.

System Status

Device Information	
Item	Data
Host Name:	NBG6617
Model Number:	NBG6617
Firmware Version:	V1.00(ABCT.0)b2
Sys OP Mode:	Router Mode
WAN Information	
- MAC Address:	66:AA:BB:CC:DD:63
- IP Address:	
- IP Subnet Mask:	
- Default Gateway:	
- IPv6 Address:	
LAN Information:	
- MAC Address:	66:AA:BB:CC:DD:62
- IP Address:	192.168.1.1
- IP Subnet Mask:	255.255.255.0
- DHCP:	Server
- IPv6 Address:	
WLAN 2.4G Information:	
- WLAN OP Mode:	Access Point Mode
- MAC Address:	66:AA:BB:CC:DD:60
- SSID:	ZyXELCCDD62
- Channel:	6
- Security:	WPA2-PSK
WLAN 5G Information:	
- WLAN OP Mode:	Access Point Mode
- MAC Address:	66:AA:BB:CC:DD:61
- SSID:	ZyXELCCDD62.speed
- Channel:	108
- Security:	WPA2-PSK
Firewall:	Enable

System Status	
Item	Data
System Up Time:	0day 2hr 0min 55sec
Current Date/Time:	2016-05-18/14:02:01
System Resource:	
- CPU Usage:	9%
- Memory Usage:	53%

Interface Status		
Interface	Status	Rate
WAN	Down	
LAN1	Down	
LAN2	Down	
LAN3	Down	
LAN4	Down	
WLAN 2.4G	UP	400 M
WLAN 5G	UP	866 M

Printer Information	
Item	Data
Printer Name:	None

8.3.1 Configure Your Notebook

Note: In this example, we use the ZyXEL NWD6505 wireless adapter as the wireless client and use the Windows built-in utility (Windows Zero Configuration (WZC)) to connect to the wireless network.

- 1 The NBG6617 supports IEEE 802.11a, IEEE 802.11b, IEEE 802.11g, IEEE 802.11n and IEEE 802.11ac wireless clients. Make sure that your notebook or computer's wireless adapter supports one of these standards.
- 2 Wireless adapters come with software sometimes called a "utility" that you install on your computer. See your wireless adapter's User's Guide for information on how to do that.
- 3 After you've installed the driver and attached the NWD6505 to your computer's USB port, right-click the **Wireless Network Connection** icon in your computer's system tray, select and click **View Available Wireless Networks**.



- 4 The **Wireless Network Connection** screen displays. Click **Refresh network list** to view the available wireless APs within range.

- 5 Select **SSID_Example3** and click **Connect**.

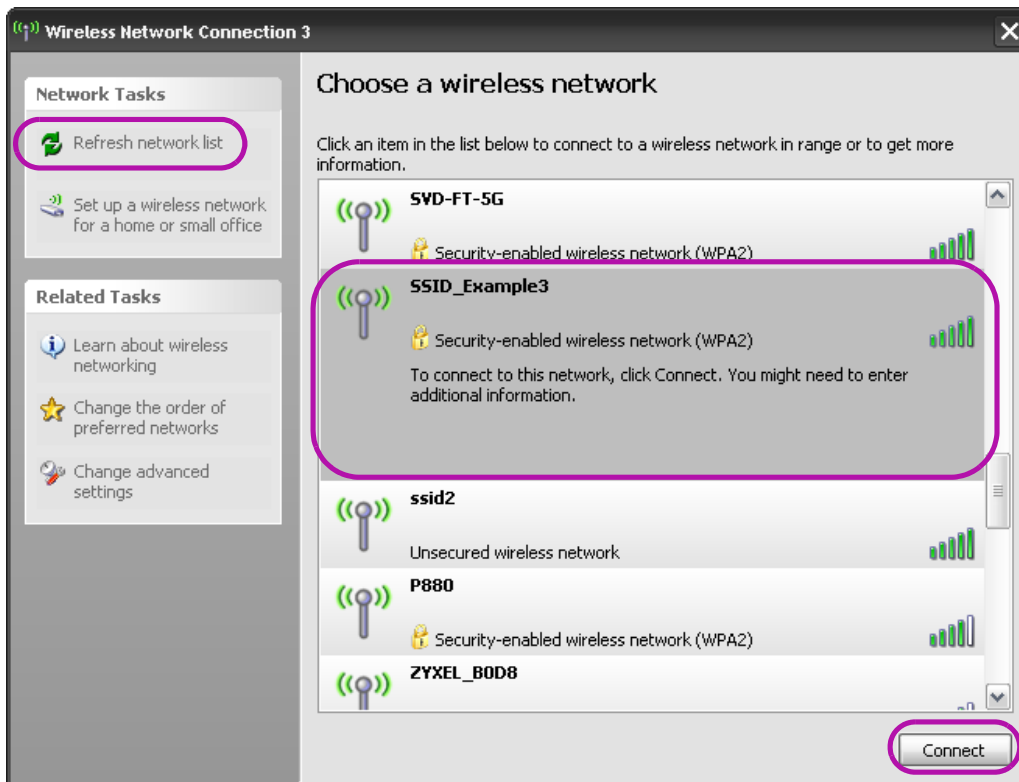

- 6 Type the security key in the following screen. Click **Connect**.

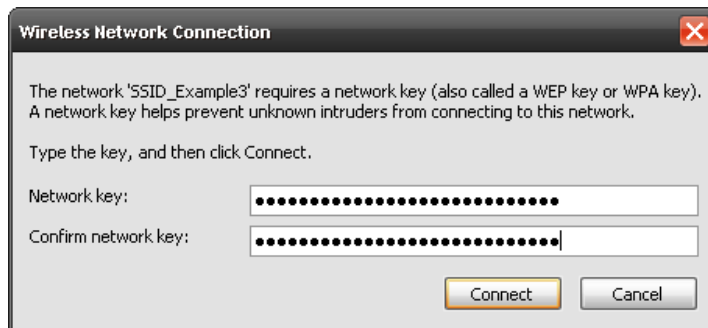

- 7 Check the status of your wireless connection in the screen below.

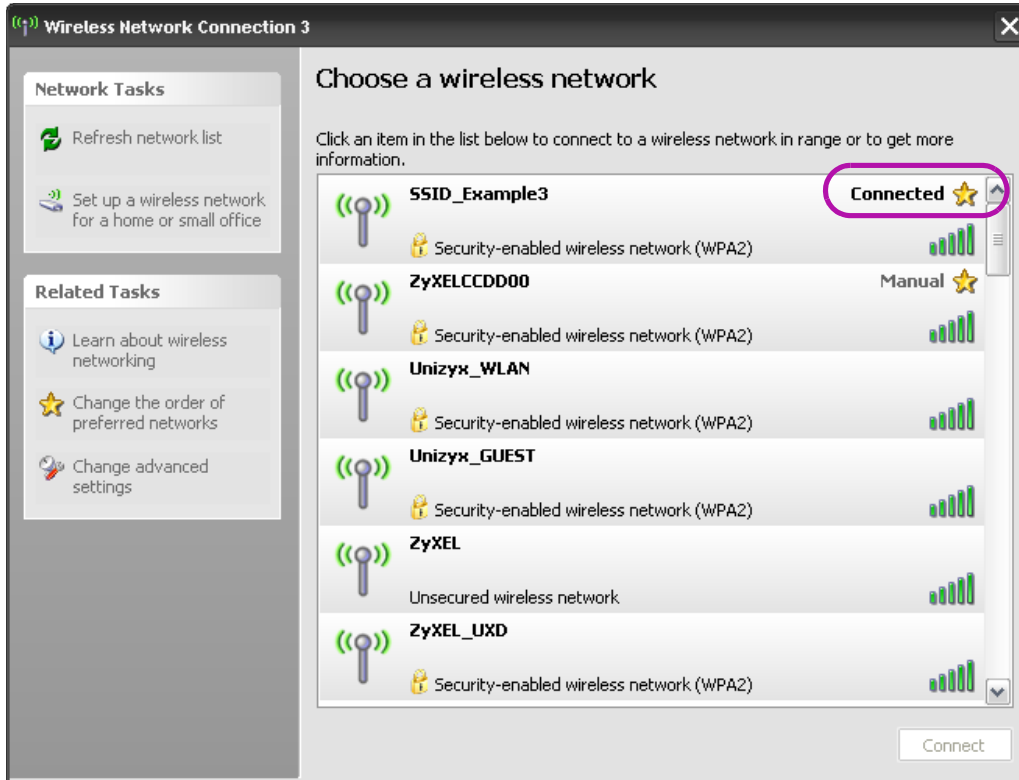

- 8 If the wireless client keeps trying to connect to or acquiring an IP address from the NBG6617, make sure you entered the correct security key.

If the connection has limited or no connectivity, make sure the DHCP server is enabled on the NBG6617.

If your connection is successful, open your Internet browser and enter <http://www.zyxel.com> or the URL of any other web site in the address bar. If you are able to access the web site, your wireless connection is successfully configured.

8.4 Using Guest SSIDs on the NBG6617

You can configure more than one guest SSID on a NBG6617. See [Section 11.4 on page 91](#).

This allows you to configure multiple independent wireless networks on the NBG6617 as if there were multiple APs (virtual APs). Each guest SSID has its own wireless security type. That is, each SSID on the NBG6617 represents a different access point/wireless network to wireless clients in the network.

Clients can associate only with the SSIDs for which they have the correct security settings. Clients using different SSIDs can access the Internet and the wired network behind the NBG6617 (such as a printer).

For example, you may set up three wireless networks (**A**, **B** and **C**) in your office. **A** is for workers, **B** is for guests and **C** is specific to a VoIP device in the meeting room.

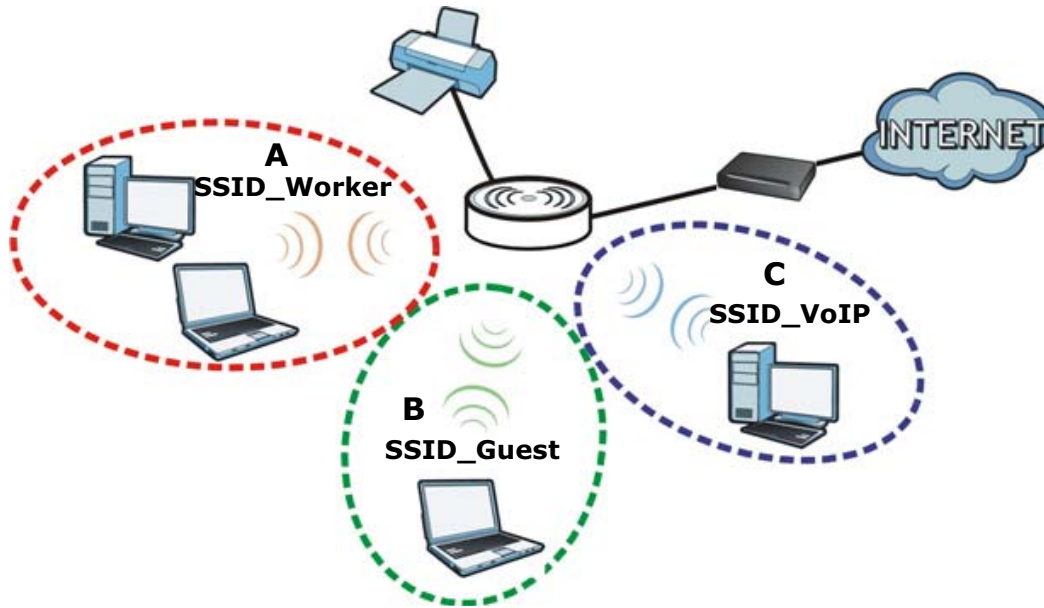

8.4.1 Configuring Security Settings of Guest SSIDs

The NBG6617 is in router mode by default.

This example shows you how to configure the SSIDs with the following parameters on your NBG6617 (in router mode).

SSID	SECURITY TYPE	KEY
SSID_Worker	WPA2-PSK	DoNotStealMyWirelessNetwork
	WPA Compatible	
SSID_VoIP	WPA-PSK	VoIPOnly12345678
SSID_Guest	WPA-PSK	keyexample123

Note: This tutorial assumes that you have disabled WPS in **Expert > Wireless > WPS**. Otherwise, the "WPA-PSK" security type is not available to configure.

- 1 Connect your computer to the LAN port of the NBG6617 using an Ethernet cable.
- 2 The default IP address of the NBG6617 in router mode is "192.168.1.1". In this case, your computer must have an IP address in the range between "192.168.1.2" and "192.168.1.254".
- 3 Click **Start > Run** on your computer in Windows. Type "cmd" in the dialog box. Enter "ipconfig" to show your computer's IP address. If your computer's IP address is not in the correct range then see [Appendix B on page 162](#) for information on changing your computer's IP address.
- 4 After you've set your computer's IP address, open a web browser such as Internet Explorer and type "http://192.168.1.1" as the web address in your web browser.

- 5 Enter "1234" (default) as the password and click **Login**.
- 6 Type a new password and retype it to confirm, then click **Apply**. Otherwise, click **Ignore**.
- 7 The **Easy Mode** appears.
- 8 Go to **Expert > Wireless > Guest Wireless**. Click the **Edit** icon of the first entry to configure wireless and security settings for **SSID_Worker**.



- 9 Configure the screen as follows. In this example, you enable **Intra-BSS Traffic** for **SSID_Worker** to allow wireless clients in the same wireless network to communicate with each other. Click **Apply**.

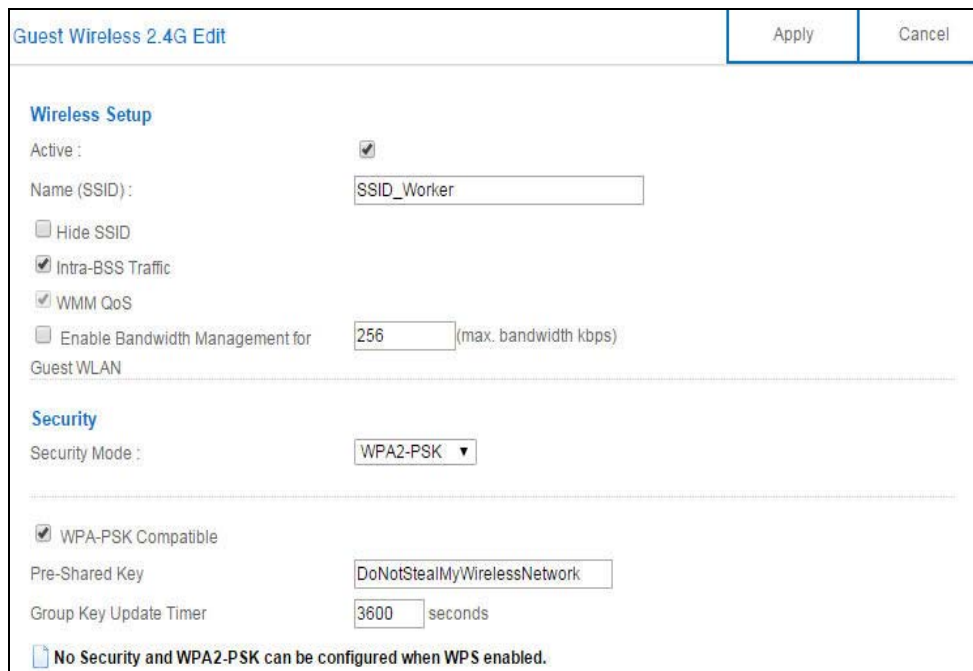

- 10 Click the **Edit** icon of the second entry to configure wireless and security settings for **SSID_VoIP**.



- 11 Configure the screen as follows. You do not enable **Intra-BSS Traffic** for **SSID_VoIP**. Click **Apply**.



- 12 Click the **Edit** icon of the third entry to configure wireless and security settings for **SSID_Guest**.



#	Status	SSID	Security	Remaining time	Edit
1	Lightbulb	SSID_Worker	WPA2-PSK	0:0:0 Set	Edit icon
2	Lightbulb	SSID_VoIP	WPA-PSK	0:0:0 Set	Edit icon
3	Lightbulb	ZyXEL_SSID3	No Security	0:0:0 Set	Edit icon (highlighted)

- 13 Configure the screen as follows. In this example, you enable **Intra-BSS Traffic** for **SSID_Guest** to allow wireless clients in the same wireless network to communicate with each other. Select **Enable Guest WLAN** to allow clients to access the Internet only. Click **Apply**.

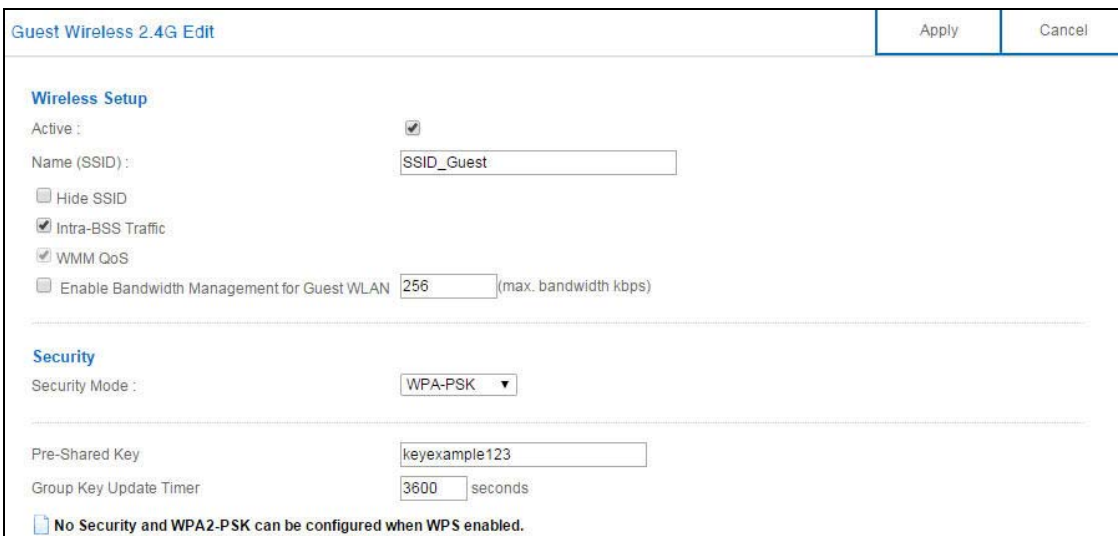

PART II

Technical Reference

9.1 Overview

This chapter discusses read-only information related to the device state of the NBG6617.

9.1.1 What You Can Do

- Use the **Client Tables** screen to view the current DHCP client information ([Section 9.2 on page 60](#)).

9.2 Client Tables Screen

You can configure the NBG6617's LAN as a DHCP server or disable it. When configured as a server, the NBG6617 assigns IP addresses to the clients. If DHCP service is disabled, you must have another DHCP server on that network, or else the computer must be manually configured.

Use this screen to view current DHCP client information (including MAC Address, and IP Address) of all network clients using the NBG6617's DHCP server.

Click **Expert Mode > Status > Client Tables** to open the **Client Tables** screen.

Figure 38 Expert Mode > Status > Client Tables

#	Online	Host Name	IP Address	MAC Address	Interface/Rssi	Lease time	Reserve
1		TWPCZT02102-01	192.168.1.88	c0:3f:d5:ba:9e:b7	LAN	84	<input type="checkbox"/>

The following table describes the labels in this screen.

Table 19 Expert Mode > Status > Client Tables

LABEL	DESCRIPTION
Interface	Select the interface from the drop-down list box to display current DHCP client information.
#	This is the index number of the host computer.
Online	This field displays whether the connection to the host computer is up (a yellow bulb) or down (a gray bulb).
Host Name	This field displays the computer host name.
IP Address	This field displays the IP address relative to the # field listed above.

Table 19 Expert Mode > Status > Client Tables

LABEL	DESCRIPTION
MAC Address	This field shows the MAC address of the computer with the name in the Host Name field. Every Ethernet device has a unique MAC (Media Access Control) address which uniquely identifies a device. The MAC address is assigned at the factory and consists of six pairs of hexadecimal characters, for example, 00:A0:C5:00:00:02.
Interface/Rssi	This field displays the device's interface type or received signal strength indicator (RSSI) that is currently connected to the NBG6617.
Lease time	This field displays the amount of time that the IP address is valid.
Reserve	Select this if you want to reserve the IP address for this specific MAC address.
Apply	Click Apply to save your changes back to the NBG6617.
Cancel	Click Cancel to reload the previous configuration for this screen.

10.1 Overview

This chapter discusses the NBG6617's **WAN** screens. Use these screens to configure your NBG6617 for Internet access.

A WAN (Wide Area Network) connection is an outside connection to another network or the Internet. It connects your private networks such as a LAN (Local Area Network) and other networks, so that a computer in one location can communicate with computers in other locations.

Figure 39 LAN and WAN

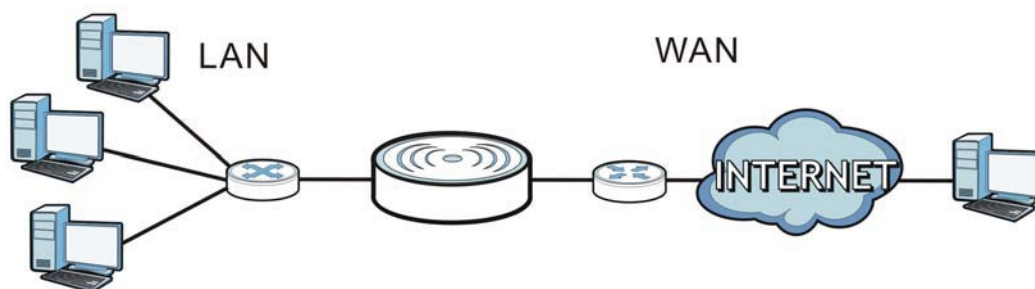

10.2 What You Can Do

- Use the **Internet Connection** screen to enter your ISP information and set how the computer acquires its IP, DNS and WAN MAC addresses ([Section 10.4 on page 65](#)).
-
- Use the **NAT > General** screen to enable NAT, set a default server and change your NBG6617's port forwarding settings ([Section 10.5.1 on page 74](#)).
- Use the **NAT > Port Trigger** screen to configure your NBG6617's trigger port settings ([Section 10.5.2 on page 76](#)).
- Use the **NAT > Passthrough** screen to configure your NBG6617's ALGs and VPN pass-through settings ([Section 10.5.3 on page 77](#)).
- Use the **Dynamic DNS** screen to change your NBG6617's DDNS settings ([Section 10.6 on page 78](#)).

10.3 What You Need To Know

The information in this section can help you configure the screens for your WAN connection, as well as enable/disable some advanced features of your NBG6617.

10.3.1 Configuring Your Internet Connection

Encapsulation Method

Encapsulation is used to include data from an upper layer protocol into a lower layer protocol. To set up a WAN connection to the Internet, you need to use the same encapsulation method used by your ISP (Internet Service Provider). If your ISP offers a dial-up Internet connection using PPPoE (PPP over Ethernet) or PPTP (Point-to-Point Tunneling Protocol), they should also provide a username and password (and service name) for user authentication.

WAN IP Address

The WAN IP address is an IP address for the NBG6617, which makes it accessible from an outside network. It is used by the NBG6617 to communicate with other devices in other networks. It can be static (fixed) or dynamically assigned by the ISP each time the NBG6617 tries to access the Internet.

If your ISP assigns you a static WAN IP address, they should also assign you the subnet mask and DNS server IP address(es) (and a gateway IP address if you use the Ethernet or ENET ENCAP encapsulation method).

DNS Server Address Assignment

Use Domain Name System (DNS) to map a domain name to its corresponding IP address and vice versa, for instance, the IP address of `www.zyxel.com` is `204.217.0.2`. The DNS server is extremely important because without it, you must know the IP address of a computer before you can access it.

The NBG6617 can get the DNS server addresses in the following ways.

- 1 The ISP tells you the DNS server addresses, usually in the form of an information sheet, when you sign up. If your ISP gives you DNS server addresses, manually enter them in the DNS server fields.
- 2 If your ISP dynamically assigns the DNS server IP addresses (along with the NBG6617's WAN IP address), set the DNS server fields to get the DNS server address from the ISP.

WAN MAC Address

The MAC address screen allows users to configure the WAN port's MAC address by either using the factory default or cloning the MAC address from a computer on your LAN. Choose **Factory Default** to select the factory assigned default MAC Address.

Otherwise, click **Clone the computer's MAC address - IP Address** and enter the IP address of the computer on the LAN whose MAC you are cloning. Once it is successfully configured, the address will be copied to configuration file. It is recommended that you clone the MAC address prior to hooking up the WAN Port.

Multicast

Traditionally, IP packets are transmitted in one of either two ways - Unicast (1 sender - 1 recipient) or Broadcast (1 sender - everybody on the network). Multicast delivers IP packets to a group of hosts on the network - not everybody and not just 1.

Figure 40 Multicast Example

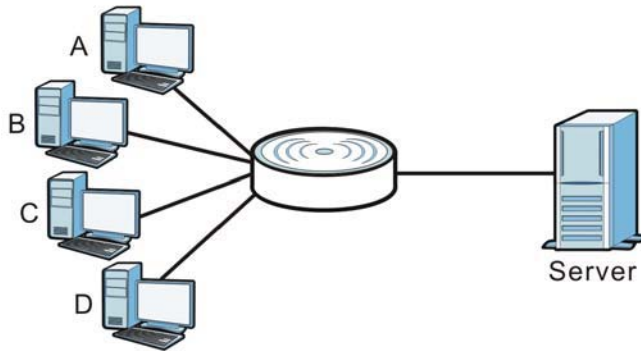

In the multicast example above, systems A and D comprise one multicast group. In multicasting, the server only needs to send one data stream and this is delivered to systems A and D.

IGMP (Internet Group Multicast Protocol) is a network-layer protocol used to establish membership in a multicast group - it is not used to carry user data. The NBG6617 supports both IGMP version 1 (**IGMP-v1**) and IGMP version 2 (**IGMP-v2**).

At start up, the NBG6617 queries all directly connected networks to gather group membership. After that, the NBG6617 periodically updates this information. IP multicasting can be enabled/disabled on the NBG6617 WAN interface in the Web Configurator (**WAN**). Select **None** to disable IP multicasting on these interfaces.

Auto-IP Change

When the NBG6617 gets a WAN IP address or a DNS server IP address which is in the same subnet as the LAN IP address 192.168.1.1, Auto-IP-Change allows the NBG6617 to change its LAN IP address to 10.0.0.1 automatically. If the NBG6617's original LAN IP address is 10.0.0.1 and the WAN IP address is in the same subnet, such as 10.0.0.3, the NBG6617 switches to use 192.168.1.1 as its LAN IP address.

Figure 41 Auto-IP-Change Example

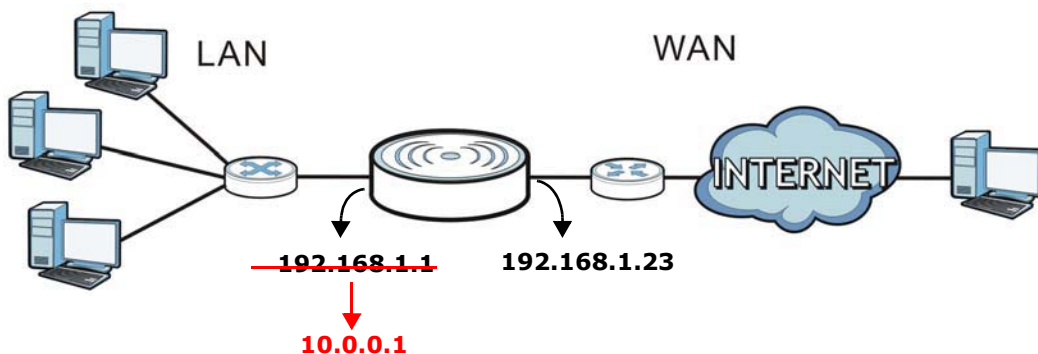

Auto-IP-Change only works under the following conditions:

- The NBG6617 must be in **Router Mode** (see [Section 15.12 on page 146](#) for more information) for Auto-IP-Change to become active.
- The NBG6617 is set to receive a dynamic WAN IP address.

10.4 Internet Connection Screen

Use this screen to change your NBG6617's Internet access settings. Click **Expert Mode > WAN > Internet Connection**.

10.4.1 IPoE Encapsulation

This screen displays when you select **IPoE** encapsulation.

Figure 42 Expert Mode > WAN > Internet Connection: IPoE Encapsulation (IPv4 Only)

Internet Connection		Apply	Cancel
ISP Parameters for Internet Access			
Encapsulation :	IPoE ▼		
IPv4 / IPv6 :	IPv4 Only ▼		
IP Address			
<input checked="" type="radio"/> Obtain an IP Address Automatically(DHCP) <input type="radio"/> Static IP Address			
IP Address :	<input type="text"/>		
Subnet Mask :	<input type="text"/>		
Default Gateway :	<input type="text"/>		
MTU Size :	1500		
DNS Server			
First DNS Server :	Obtained From ISP ▼	<input type="text"/>	
Second DNS Server :	Obtained From ISP ▼	<input type="text"/>	
Third DNS Server :	Obtained From ISP ▼	<input type="text"/>	
WAN MAC Address			
<input checked="" type="radio"/> Factory default <input type="radio"/> Clone the computer's MAC address - IP Address <input type="text"/> <input type="radio"/> Set WAN MAC Address <input type="text"/>			
IPv6 Tunneling			
IPv6 Tunneling :	6RD ▼		
<input type="radio"/> Automatically configured by DHCP <input checked="" type="radio"/> Manually Configured			
Border Relay IPv4 Address:	<input type="text"/>		
Service Provider IPv6 Prefix:	<input type="text"/>		
Service Provider IPv6 Prefix length:	32 32~64		
IPv4 mask length:	0 0~32		
IPv6 DNS Server			
First DNS Server :	<input type="text"/>		
Second DNS Server :	<input type="text"/>		
Third DNS Server :	<input type="text"/>		
Multicast Setup			
Multicast Setup :	IGMPv1/v2 ▼		
Auto-Subnet Configuration			
<input checked="" type="checkbox"/> Enable Auto-IP-Change Mode			

The following table describes the labels in this screen.

Table 20 Network > WAN > Internet Connection: IPoE Encapsulation

LABEL	DESCRIPTION
ISP Parameters for Internet Access	
Encapsulation	You must choose the IPoE option when the WAN port is used as a regular Ethernet.
IPv4 / IPv6	Select IPv4 Only if you want the NBG6617 to run IPv4 only. Select Dual Stack to allow the NBG6617 to run IPv4 and IPv6 at the same time. Select IPv6 Only if you want the NBG6617 to run IPv6 only.
IP Address	
Obtain an IP Address Automatically (DHCP)	Select this option if your ISP did not assign you a fixed IP address. This is the default selection.
Static IP Address	Select this option if the ISP assigned a fixed IP address.
IP Address	Enter your WAN IP address in this field if you selected Static IP Address .
Subnet Mask	Enter the Subnet Mask in this field.
Default Gateway	Enter a gateway IP address (if your ISP gave you one) in this field.
MTU Size	Enter the MTU (Maximum Transmission Unit) size for each packet. If a larger packet arrives, the NBG6617 divides it into smaller fragments.
DNS Server	
First DNS Server	Select Obtained From ISP if your ISP dynamically assigns DNS server information (and the NBG6617's WAN IP address). The field to the right displays the (read-only) DNS server IP address that the ISP assigns. Select User-Defined if you have the IP address of a DNS server. Enter the DNS server's IP address in the field to the right. Select None if you do not want to configure DNS servers. If you do not configure a DNS server, you must know the IP address of a computer in order to access it.
Second DNS Server	
Third DNS Server	
WAN MAC Address	
Once the WAN MAC address is successfully configured, the address will be copied to the configuration file. It will not change unless you change the setting or upload a different configuration file.	
Factory default	Select this option to have the WAN interface use the factory assigned default MAC address. By default, the NBG6617 uses the factory assigned MAC address to identify itself.
Clone the computer's MAC address - IP Address	Select this option to have the WAN interface use a different MAC address by cloning the MAC address of another device or computer. Enter the IP address of the device or computer whose MAC you are cloning.
Set WAN MAC Address	Select this option to have the WAN interface use a manually specified MAC address. Enter the MAC address in the fields.
IPv6 Tunneling	
Use IPv6 tunneling when the local network uses IPv6 and the ISP has an IPv4 network. When the NBG6617 has an IPv4 WAN address and you set IPv4/IPv6 mode to IPv4 Only , you can enable IPv6 tunneling to encapsulate IPv6 packets in IPv4 packets to cross the ISP's IPv4 network.	

Table 20 Network > WAN > Internet Connection: IPoE Encapsulation (continued)

LABEL	DESCRIPTION
IPv6 Tunneling	<p>Select None to not allow IPv6 packets to cross IPv4 networks.</p> <p>Select 6RD to enable 6RD. IPv6 Rapid Deployment (6RD) is an IPv6 transitioning process for stateless tunneling of IPv6 over IPv4. Enable 6RD to allow tunneling across an ISP's IPv4 only access network.</p> <p>Select 6to4 to transmit IPv6 packets over an IPv4 network. A 6to4 relay router is required to route 6to4 packets to a native IPv6 network.</p> <p>Select 6in4 if the NBG6617 has a public IPv4 address and you want to transmit your IPv6 packets to one and only one remote site whose LAN network is also an IPv6 network. You must know the WAN IP address of the remote gateway.</p>
6RD	<p>The NBG6617 generates a global IPv6 prefix from its IPv4 WAN address and tunnels IPv6 traffic to the ISP's Border Relay router to connect to the native IPv6 Internet. The local network can also use IPv4 services. The NBG6617 uses its configured IPv4 WAN IP to route IPv4 traffic to the IPv4 Internet.</p> <p>This is available only when you select IPv4 Only in the IPv4/IPv6 field.</p>
Automatically configured by DHCP	Select this to have the NBG6617 detect the relay server's IP address automatically through DHCP.
Manually Configured	Select this if you have the IPv4 address of the relay server.
Border Relay IPv4 Address	Specify the relay server's IPv4 address.
Service Provider IPv6 Prefix	Enter an IPv6 prefix for tunneling IPv6 traffic to the ISP's Border Relay router and connecting to the native IPv6 Internet.
Service Provider IPv6 Prefix length	<p>Enter the IPv6 prefix length.</p> <p>An IPv6 prefix length specifies how many most significant bits (starting from the left) in the address compose the network address.</p>
IPv4 mask length	Enter the subnet mask number (1~32) for the IPv4 network.
6to4	<p>The NBG6617 should get a public IPv4 address for the WAN. The NBG6617 adds an IPv4 IP header to an IPv6 packet when transmitting the packet to the Internet. In reverse, the NBG6617 removes the IPv4 header from an IPv6 packet when receiving it from the Internet.</p> <p>This is available only when you select IPv4 Only in the IPv4/IPv6 field.</p>
Relay Server IPv4 Address	Enter the IPv4 address of a 6to4 relay server which helps forward packets between 6to4 networks and native IPv6 networks.
6in4	<p>The NBG6617 encapsulates IPv6 packets within IPv4 packets across the Internet. You must know the WAN IP address of the remote gateway device. This mode is normally used for a site-to-site application such as two branch offices.</p> <p>This is available only when you select IPv4 Only in the IPv4/IPv6 field.</p>
Remote IPv4 Address	Enter the IPv4 address of the remote gateway to which this interface tunnels traffic.
Remote IPv6 Address	Enter the IPv6 address of the remote gateway to which this interface tunnels traffic.
Local IPv6 Address	Enter the IPv6 address assigned by your ISP.
IPv6 Prefix	Enter the IPv6 prefix for this interface if you want to use a static IP address.

Table 20 Network > WAN > Internet Connection: IPoE Encapsulation (continued)

LABEL	DESCRIPTION
IPv6 DNS Server This is available only when you select IPv4 Only in the IPv4/IPv6 field and set IPv6 Tunneling to 6RD , 6in4 or 6to4 .	
First DNS Server	Specify the DNS server IPv6 address assigned by the ISP.
Second DNS Server	
Third DNS Server	
IPv6 Address This section is NOT available when you select IPv4 Only in the IPv4/IPv6 field.	
Obtain an IP Address Automatically(DHCP)	Select this option if you want to obtain an IPv6 address from a DHCPv6 server. <ul style="list-style-type: none"> Select DUID-LL (Default) to have the NBG6617 use DUID-LL (DUID Based on Link-layer Address) for identification when exchanging DHCPv6 messages. Select DUID-LLT to have the NBG6617 use DUID-LLT (DUID Based on Link-layer Address Plus Time) for identification when exchanging DHCPv6 messages.
Static IP Address	Select this option if you have a fixed IPv6 address assigned by your ISP.
IPv6 Address	Enter the IPv6 address assigned by your ISP.
Prefix length	Enter the address prefix length to specify how many most significant bits in an IPv6 address compose the network address.
IPv6 Default Gateway	Enter the IPv6 address of the next-hop gateway. The gateway helps forward packets to their destinations.
Link Local Only	Select this option to use the link-local address which uniquely identifies a device on the local network (the LAN).
IPv6 DNS Server This is available only when you select Dual Stack or IPv6 Only in the IPv4/IPv6 field.	
First DNS Server	Select Obtained From ISP to have the NBG6617 get the IPv6 DNS server addresses from the ISP automatically. Select User-Defined and enter the IPv6 DNS server address assigned by the ISP to have the NBG6617 use the IPv6 DNS server addresses you configure manually. Select None if you do not want to configure DNS servers. If you do not configure a DNS server, you must know the IPv6 address of a computer in order to access it.
Second DNS Server	
Third DNS Server	
Multicast Setup	
Multicast Setup	Select IGMPv1/v2 to enable multicasting. This applies to traffic routed from the WAN to the LAN. Select None to disable this feature. This may cause incoming traffic to be dropped or sent to all connected network devices.
Auto-Subnet Configuration	
Enable Auto-IP-Change Mode	Select this option to have the NBG6617 change its LAN IP address to 10.0.0.1 or 192.168.1.1 accordingly when the NBG6617 gets a dynamic WAN IP address in the same subnet as the LAN IP address. Select this option to have the NBG6617 change its LAN IP address to 10.0.0.1 or 192.168.1.1 accordingly when the NBG6617 gets a DNS server IP address in the same subnet as the LAN IP address. The NAT, DHCP server and firewall functions on the NBG6617 are still available in this mode.
Apply	Click Apply to save your changes back to the NBG6617.
Cancel	Click Cancel to begin configuring this screen afresh.

10.4.2 PPPoE Encapsulation

The NBG6617 supports PPPoE (Point-to-Point Protocol over Ethernet). PPPoE is an IETF standard (RFC 2516) specifying how a personal computer (PC) interacts with a broadband modem (DSL, cable, wireless, etc.) connection. The **PPP over Ethernet** option is for a dial-up connection using PPPoE.

For the service provider, PPPoE offers an access and authentication method that works with existing access control systems (for example Radius).

One of the benefits of PPPoE is the ability to let you access one of multiple network services, a function known as dynamic service selection. This enables the service provider to easily create and offer new IP services for individuals.

Operationally, PPPoE saves significant effort for both you and the ISP or carrier, as it requires no specific configuration of the broadband modem at the customer site.

By implementing PPPoE directly on the NBG6617 (rather than individual computers), the computers on the LAN do not need PPPoE software installed, since the NBG6617 does that part of the task. Furthermore, with NAT, all of the LANs' computers will have access.

This screen displays when you select **PPPoE** encapsulation.

Figure 43 Network > WAN > Internet Connection: PPPoE Encapsulation (IPv4 Only)

Internet Connection		Apply	Cancel
ISP Parameters for Internet Access			
Encapsulation :	<input type="text" value="PPPoE"/>		
IPv4 / IPv6 :	<input type="text" value="IPv4 Only"/>		
PPP Information			
PPP Username :	<input type="text"/>		
PPP Password :	<input type="text"/>		
MTU Size :	<input type="text" value="1454"/>		
PPP Auto Connect :	<input checked="" type="checkbox"/>		
IDLE Timeout [second] :	<input type="text" value="300"/>		
PPPoE Service Name :	<input type="text"/>		
WAN IP Address Assignment			
<input type="radio"/> Get automatically from ISP			
<input checked="" type="radio"/> Use Fixed IP Address	<input type="text"/>		
DNS Server			
First DNS Server :	<input type="text" value="User-Defined"/>	<input type="text"/>	
Second DNS Server :	<input type="text" value="User-Defined"/>	<input type="text"/>	
Third DNS Server :	<input type="text" value="User-Defined"/>	<input type="text"/>	
WAN MAC Address			
<input checked="" type="radio"/> Factory default			
<input type="radio"/> Clone the computer's MAC address - IP Address	<input type="text"/>		
<input type="radio"/> Set WAN MAC Address	<input type="text"/>		
IPv6 Tunneling			
IPv6 Tunneling :	<input type="text" value="6in4"/>		
Remote IPv4 Address:	<input type="text"/>		
Remote IPv6 Address:	<input type="text"/>		
Local IPv6 Address:	<input type="text"/>		
IPv6 Prefix:	<input type="text"/>		
IPv6 DNS Server			
First DNS Server :	<input type="text"/>		
Second DNS Server :	<input type="text"/>		
Third DNS Server :	<input type="text"/>		
Multicast Setup			
Multicast Setup :	<input type="text" value="IGMPv1/v2"/>		
Auto-Subnet Configuration			
<input checked="" type="checkbox"/> Enable Auto-IP-Change Mode			

The following table describes the labels in this screen.

Table 21 Network > WAN > Internet Connection: PPPoE Encapsulation

LABEL	DESCRIPTION
ISP Parameters for Internet Access	
Encapsulation	Select PPPoE if you connect to your Internet via dial-up.
IPv4 / IPv6	Select IPv4 Only if you want the NBG6617 to run IPv4 only. Select Dual Stack to allow the NBG6617 to run IPv4 and IPv6 at the same time. Select IPv6 Only if you want the NBG6617 to run IPv6 only.
PPP Information	
PPP Username	Type the user name given to you by your ISP.
PPP Password	Type the password associated with the user name above.
MTU Size	Enter the Maximum Transmission Unit (MTU) or the largest packet size per frame that your NBG6617 can receive and process.
PPP Auto Connect	Select this option if you do not want the connection to time out.
IDLE Timeout (second)	This value specifies the time in minutes that elapses before the router automatically disconnects from the PPPoE server.
PPPoE Service Name	Enter the PPPoE service name specified in the ISP account.
WAN IP Address Assignment	
Get automatically from ISP	Select this option if your ISP did not assign you a fixed IP address. This is the default selection.
Use Fixed IP Address	Select this option and enter your WAN IP address if the ISP assigned a fixed IP address.
DNS Server	
First DNS Server	Select Obtained From ISP if your ISP dynamically assigns DNS server information (and the NBG6617's WAN IP address). The field to the right displays the (read-only) DNS server IP address that the ISP assigns. Select User-Defined if you have the IP address of a DNS server. Enter the DNS server's IP address in the field to the right. Select None if you do not want to configure DNS servers. If you do not configure a DNS server, you must know the IP address of a computer in order to access it.
Second DNS Server	
Third DNS Server	
WAN MAC Address	
The MAC address section allows users to configure the WAN port's MAC address by using the NBG6617's MAC address, copying the MAC address from a computer on your LAN or manually entering a MAC address.	
Factory default	Select Factory default to use the factory assigned default MAC Address.
Clone the computer's MAC address - IP Address	Select Clone the computer's MAC address - IP Address and enter the IP address of the computer on the LAN whose MAC you are cloning.
Set WAN MAC Address	Select this option and enter the MAC address you want to use.
IPv6 Tunneling	
Use IPv6 tunneling when the local network uses IPv6 and the ISP has an IPv4 network. When the NBG6617 has an IPv4 WAN address and you set IPv4/IPv6 mode to IPv4 Only , you can enable IPv6 tunneling to encapsulate IPv6 packets in IPv4 packets to cross the ISP's IPv4 network.	

Table 21 Network > WAN > Internet Connection: PPPoE Encapsulation (continued)

LABEL	DESCRIPTION
IPv6 Tunneling	<p>Select None to not allow IPv6 packets to cross IPv4 networks.</p> <p>Select 6RD to enable 6RD. IPv6 Rapid Deployment (6RD) is an IPv6 transitioning process for stateless tunneling of IPv6 over IPv4. Enable 6RD to allow tunneling across an ISP's IPv4 only access network.</p> <p>Select 6to4 to transmit IPv6 packets over an IPv4 network. A 6to4 relay router is required to route 6to4 packets to a native IPv6 network.</p> <p>Select 6in4 if the NBG6617 has a public IPv4 address and you want to transmit your IPv6 packets to one and only one remote site whose LAN network is also an IPv6 network. You must know the WAN IP address of the remote gateway.</p>
6RD	<p>The NBG6617 generates a global IPv6 prefix from its IPv4 WAN address and tunnels IPv6 traffic to the ISP's Border Relay router to connect to the native IPv6 Internet. The local network can also use IPv4 services. The NBG6617 uses its configured IPv4 WAN IP to route IPv4 traffic to the IPv4 Internet.</p> <p>This is available only when you select IPv4 Only in the IPv4/IPv6 field.</p>
Automatically configured by DHCP	Select this to have the NBG6617 detect the relay server's IP address automatically through DHCP.
Manually Configured	Select this if you have the IPv4 address of the relay server.
Border Relay IPv4 Address	Specify the relay server's IPv4 address.
Service Provider IPv6 Prefix	Enter an IPv6 prefix for tunneling IPv6 traffic to the ISP's Border Relay router and connecting to the native IPv6 Internet.
Service Provider IPv6 Prefix length	<p>Enter the IPv6 prefix length.</p> <p>An IPv6 prefix length specifies how many most significant bits (starting from the left) in the address compose the network address.</p>
IPv4 mask length	Enter the subnet mask number (1~32) for the IPv4 network.
6to4	<p>The NBG6617 should get a public IPv4 address for the WAN. The NBG6617 adds an IPv4 IP header to an IPv6 packet when transmitting the packet to the Internet. In reverse, the NBG6617 removes the IPv4 header from an IPv6 packet when receiving it from the Internet.</p> <p>This is available only when you select IPv4 Only in the IPv4/IPv6 field.</p>
Relay Server IPv4 Address	Enter the IPv4 address of a 6to4 relay server which helps forward packets between 6to4 networks and native IPv6 networks.
6in4	<p>The NBG6617 encapsulates IPv6 packets within IPv4 packets across the Internet. You must know the WAN IP address of the remote gateway device. This mode is normally used for a site-to-site application such as two branch offices.</p> <p>This is available only when you select IPv4 Only in the IPv4/IPv6 field.</p>
Remote IPv4 Address	Enter the IPv4 address of the remote gateway to which this interface tunnels traffic.
Remote IPv6 Address	Enter the IPv6 address of the remote gateway to which this interface tunnels traffic.
Local IPv6 Address	Enter the IPv6 address assigned by your ISP.
IPv6 Prefix	Enter the IPv6 prefix for this interface if you want to use a static IP address.

Table 21 Network > WAN > Internet Connection: PPPoE Encapsulation (continued)

LABEL	DESCRIPTION
IPv6 DNS Server	This is available only when you select IPv4 Only in the IPv4/IPv6 field and set IPv6 Tunneling to 6RD , 6in4 or 6to4 .
First DNS Server Second DNS Server Third DNS Server	Specify the DNS server IPv6 address assigned by the ISP.
IPv6 DNS Server	This is available only when you select Dual Stack or IPv6 Only in the IPv4/IPv6 field.
First DNS Server Second DNS Server Third DNS Server	Select Obtained From ISP to have the NBG6617 get the IPv6 DNS server addresses from the ISP automatically. Select User-Defined and enter the IPv6 DNS server address assigned by the ISP to have the NBG6617 use the IPv6 DNS server addresses you configure manually. Select None if you do not want to configure DNS servers. If you do not configure a DNS server, you must know the IPv6 address of a computer in order to access it.
Multicast Setup	
Multicast Setup	Select IGMPv1/v2 to enable multicasting. This applies to traffic routed from the WAN to the LAN. Select None to disable this feature. This may cause incoming traffic to be dropped or sent to all connected network devices.
Auto-Subnet Configuration	
Enable Auto-IP-Change Mode	Select this option to have the NBG6617 change its LAN IP address to 10.0.0.1 or 192.168.1.1 accordingly when the NBG6617 gets a dynamic WAN IP address in the same subnet as the LAN IP address. Select this option to have the NBG6617 change its LAN IP address to 10.0.0.1 or 192.168.1.1 accordingly when the NBG6617 gets a DNS server IP address in the same subnet as the LAN IP address. The NAT, DHCP server and firewall functions on the NBG6617 are still available in this mode.
Apply	Click Apply to save your changes back to the NBG6617.
Cancel	Click Cancel to begin configuring this screen afresh.

10.5 NAT

Use this screen to change your NBG6617's NAT (Network Address Translation) settings. Click **Expert Mode > WAN > NAT**.

10.5.1 General Screen

Use this screen to enable NAT, set a default server and configure your NBG6617's port forwarding settings to forward incoming service requests to the server(s) on your local network. Click **Expert Mode > WAN > NAT > General**.

Figure 44 Expert Mode > WAN > NAT > General

The screenshot shows the 'General' configuration page for NAT. At the top right are 'Apply' and 'Cancel' buttons. The 'Network Address Translation(NAT)' section has radio buttons for 'Enable' (selected) and 'Disable'. The 'Default Server Setup' section has radio buttons for 'Default Server' (selected) and 'Change To Server'. The 'Default Server' field contains '192.168.1.1'. The 'Change To Server' section has a dropdown menu with 'TWPCZT02102-01' selected and a text field with '192.168.1.88'. The 'Port Forwarding (Max Limit : 32)' section contains a table with the following data:

#	Name	Protocol	Local Port	Server IP Address	Port
1	WWW	TCP_UDP	80	192.168.1.88	80

The following table describes the labels in this screen.

Table 22 Expert Mode > WAN > NAT > General

LABEL	DESCRIPTION
General	
Network Address Translation (NAT)	Network Address Translation (NAT) allows the translation of an Internet protocol address used within one network (for example a private IP address used in a local network) to a different IP address known within another network (for example a public IP address used on the Internet). Select Enable to activate NAT. Select Disable to turn it off.
Default Server Setup	
Default Server	You can decide whether you want to use the default server or specify a server manually. In addition to the servers for specified services, NAT supports a default server. A default server receives packets from ports that are not specified in the port forwarding summary table below. Select this to use the default server.
Change To Server	Select this and manually enter the server's IP address.
Port Forwarding (Max Limit : 32)	
#	This is the number of an individual port forwarding server entry.
Name	Select a pre-defined service from the drop-down list box. The pre-defined service port number(s) and protocol will be displayed in the port forwarding summary table. Otherwise, select User define to manually enter the Port number(s) and select the Protocol .
Protocol	Select the transport layer protocol supported by this virtual server. Choices are TCP , UDP , or TCP_UDP . If you have chosen a pre-defined service in the Name field, the protocol will be configured automatically.
Local Port	This shows the port number(s) that identifies the service if you select a pre-defined service. If you select User define in the Name field, enter the port number(s) manually.
Server IP Address	Select User define to manually enter the inside IP address of the virtual server here.
Port	This shows the port number(s) that identifies the service if you select a pre-defined service. If you select User define in the Name field, enter the port number(s) manually.
Name	This field displays a name to identify this rule.

Table 22 Expert Mode > WAN > NAT > General (continued)

LABEL	DESCRIPTION
Protocol	This is the transport layer protocol used for the service.
Local Port	This field displays the port number(s).
Server IP Address	This field displays the inside IP address of the server.
Port	This field displays the port number(s).
Add	Click + to add the rule in the port forwarding summary table.
Delete	Click - to remove a rule.
Apply	Click Apply to save your changes back to the NBG6617.
Cancel	Click Cancel to begin configuring this screen afresh.

10.5.2 Port Trigger Screen

To change your NBG6617's trigger port settings, click **Expert Mode > WAN > NAT > Port Trigger**. The screen appears as shown.

Note: Only one LAN computer can use a trigger port (range) at a time.

Figure 45 Expert Mode > WAN > NAT > Port Trigger



The following table describes the labels in this screen.

Table 23 Expert Mode > WAN > NAT > Port Trigger

LABEL	DESCRIPTION
Port Trigger Rules (Max Limit : 32)	
#	This is the rule index number (read-only).
Name	Type a unique name (up to 15 characters) for identification purposes. All characters are permitted - including spaces.
Incoming Port	Incoming is a port (or a range of ports) that a server on the WAN uses when it sends out a particular service. The NBG6617 forwards the traffic with this port (or range of ports) to the client computer on the LAN that requested the service. Type a port number or the starting port number in a range of port numbers.
End Port	Type a port number or the ending port number in a range of port numbers.
Trigger Port	The trigger port is a port (or a range of ports) that causes (or triggers) the NBG6617 to record the IP address of the LAN computer that sent the traffic to a server on the WAN. Type a port number or the starting port number in a range of port numbers.
End Port	Type a port number or the ending port number in a range of port numbers.
Add	Click + to add the rule in the port trigger summary table.
Delete	Click - to remove a rule.

Table 23 Expert Mode > WAN > NAT > Port Trigger (continued)

LABEL	DESCRIPTION
Apply	Click Apply to save your changes back to the NBG6617.
Cancel	Click Cancel to begin configuring this screen afresh.

10.5.3 Passthrough Screen

ALG Overview

Application Layer Gateway (ALG) allows the following applications to operate properly through the NBG6617's NAT.

- SIP - Session Initiation Protocol (SIP) - An application-layer protocol that can be used to create voice and multimedia sessions over Internet.
- H.323 - A teleconferencing protocol suite that provides audio, data and video conferencing.
- FTP - File Transfer Protocol - an Internet file transfer service.
- SNMP - Simple Network Management Protocol - An application-layer protocol that can be used to exchange management information between network devices.
- RTSP - Real Time Streaming Protocol - a remote control for multimedia on the Internet.
- IRC - Internet Relay Chat - An application-layer protocol that can be used to communicate in the form of text.

The ALG feature is only needed for traffic that goes through the NBG6617's NAT.

To change your NBG6617's ALGs and VPN pass-through settings, click **Expert Mode > WAN > NAT > Passthrough**. The screen appears as shown.

Figure 46 Expert Mode > WAN > NAT > Passthrough

The screenshot shows the 'Passthrough' configuration page. At the top, there are 'Apply' and 'Cancel' buttons. Below the title, there are two main sections:

- ALG Setup :**
 - FTP : Enable Disable
 - H.323 : Enable Disable
 - SIP : Enable Disable
 - SNMP : Enable Disable
 - RTSP : Enable Disable
 - IRC : Enable Disable
- VPN Passthrough :**
 - PPTP : Enable Disable
 - L2TP : Enable Disable
 - IPSEC : Enable Disable

The following table describes the labels in this screen.

Table 24 Expert Mode > WAN > NAT > Passthrough

LABEL	DESCRIPTION
ALG Setup	
FTP	Select Enable to allow TCP packets with a specified port destination to pass through.
H.323	Select Enable to allow peer-to-peer H.323 calls.
SIP	Select Enable to make sure SIP (VoIP) works correctly with port-forwarding and address-mapping rules.
SNMP	Select Enable to allow a manager station to manage and monitor the NBG6617 through the network via SNMP.
RTSP	RTSP (Real Time Streaming Protocol) is a protocol used to stop, pause or play video and audio applications streaming on the Internet. Select Enable to have the NBG6617 detect RTSP traffic and help build RTSP sessions through its NAT.
IRC	Select Enable to allow clients to communicate in the form of text.
VPN Passthrough	
PPTP	Select Enable to allow VPN clients to make outbound PPTP connections. It is required in order to connect to a PPTP VPN account. If PPTP is disabled, then when a client sends a request to a VPN server, the server will reply to the NBG6617 and the NBG6617 will drop the request. When PPTP is enabled, the NBG6617 will forward the reply from the VPN server to the client that initiated the request, and the connection will establish successfully.
L2TP	Select Enable to allow VPN clients to make outbound L2TP connections. It is required in order to connect to a L2TP VPN account. If L2TP is disabled, then when a client sends a request to a VPN server, the server will reply to the NBG6617 and the NBG6617 will drop the request. When L2TP is enabled, the NBG6617 will forward the reply from the VPN server to the client that initiated the request, and the connection will establish successfully.
IPSEC	Select Enable to allow VPN clients to make outbound IPsec connections. It is required in order to connect to a IPsec VPN account. If IPSEC is disabled, then when a client sends a request to a VPN server, the server will reply to the NBG6617 and the NBG6617 will drop the request. When IPSEC is enabled, the NBG6617 will forward the reply from the VPN server to the client that initiated the request, and the connection will establish successfully.
Apply	Click Apply to save your changes back to the NBG6617.
Cancel	Click Cancel to begin configuring this screen afresh.

10.6 Dynamic DNS Screen

To change your NBG6617's DDNS, click **Expert Mode > WAN > Dynamic DNS**. The screen appears as shown.

Figure 47 Expert Mode > WAN > Dynamic DNS

Dynamic DNS		Apply	Cancel
Dynamic DNS Setup			
<p>DNS maps a domain name to a corresponding IP address and vice versa. Similarly, Dynamic DNS (DDNS) maps a domain name to a dynamic IP address. With DDNS, you can use a domain name to access your ZyXEL device and home network regardless of the device's current (dynamic) IP address. The ZyXEL device must have a public WAN IP address to use Dynamic DNS.</p> <p>Register at https://mycloud.zyxel.com/ and get a free accessible-from-anywhere network name as well as other ZyXEL services.</p>			
Dynamic DNS :	<input type="radio"/> Enable <input checked="" type="radio"/> Disable		
Service Provider :	<input type="text" value="www.DynDNS.org"/> DynDNS		
Host Name :	<input type="text"/>		
Username :	<input type="text"/>		
Password :	<input type="text"/>		

The following table describes the labels in this screen.

Table 25 Expert Mode > WAN > Dynamic DNS

LABEL	DESCRIPTION
Dynamic DNS Setup	
Dynamic DNS	Select Enable to use dynamic DNS. Select Disable to turn this feature off.
Service Provider	Select the name of your Dynamic DNS service provider.
Host Name	Enter a host names in the field provided. You can specify up to two host names in the field separated by a comma (",").
Username	Enter your user name.
Password	Enter the password assigned to you.
Apply	Click Apply to save your changes back to the NBG6617.
Cancel	Click Cancel to begin configuring this screen afresh.

Wireless LAN

11.1 Overview

This chapter discusses how to configure the wireless network settings in your NBG6617. The NBG6617 is able to function both 2.4GHz and 5GHz network at the same time. You can have different wireless and wireless security settings for 2.4GHz and 5GHz wireless LANs. Click **Expert Mode > Wireless** to configure **wireless LAN 2.4G** or **wireless LAN 5G**.

See the appendices for more detailed information about wireless networks.

The following figure provides an example of a wireless network.

Figure 48 Example of a Wireless Network

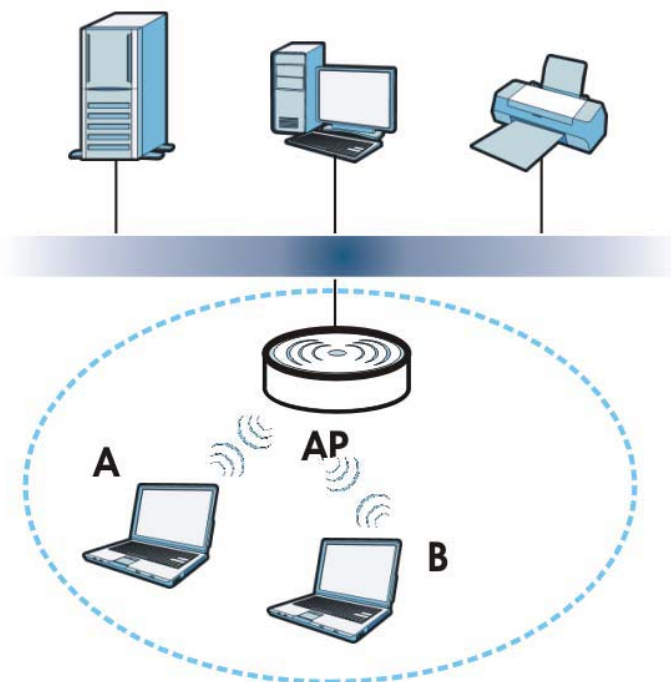

The wireless network is the part in the blue circle. In this wireless network, devices **A** and **B** are called wireless clients. The wireless clients use the access point (AP) to interact with other devices (such as the printer) or with the Internet. Your NBG6617 is the AP.

11.1.1 What You Can Do

- Use the **Wireless** screen to enable or disable the 2.4GHz or 5GHz wireless LAN, set up wireless security between the NBG6617 and the wireless clients, and make other basic configuration changes ([Section 11.2 on page 85](#)).
- Use the **Guest Wireless** screen to set up multiple wireless networks on your NBG6617 ([Section 11.4 on page 91](#)).
- Use the **MAC Filter** screen to allow or deny wireless stations based on their MAC addresses from connecting to the NBG6617 ([Section 11.5 on page 93](#)).
- Use the **Advanced** screen to allow intra-BSS networking and set the RTS/CTS Threshold ([Section 11.6 on page 94](#)).
- Use the **WPS** screen to quickly set up a wireless network with strong security, without having to configure security settings manually ([Section 11.7 on page 96](#)).
- Use the **Scheduling** screen to set the times your wireless LAN is turned on and off ([Section 11.8 on page 97](#)).

11.1.2 What You Should Know

Every wireless network must follow these basic guidelines.

- Every wireless client in the same wireless network must use the same SSID.
The SSID is the name of the wireless network. It stands for Service Set IDentity.
- If two wireless networks overlap, they should use different channels.
Like radio stations or television channels, each wireless network uses a specific channel, or frequency, to send and receive information.
- Every wireless client in the same wireless network must use security compatible with the AP.
Security stops unauthorized devices from using the wireless network. It can also protect the information that is sent in the wireless network.

Wireless Security Overview

The following sections introduce different types of wireless security you can set up in the wireless network.

SSID

Normally, the AP acts like a beacon and regularly broadcasts the SSID in the area. You can hide the SSID instead, in which case the AP does not broadcast the SSID. In addition, you should change the default SSID to something that is difficult to guess.

This type of security is fairly weak, however, because there are ways for unauthorized devices to get the SSID. In addition, unauthorized devices can still see the information that is sent in the wireless network.

MAC Address Filter

Every wireless client has a unique identification number, called a MAC address.¹ A MAC address is usually written using twelve hexadecimal characters²; for example, 00A0C5000002 or 00:A0:C5:00:00:02. To get the MAC address for each wireless client, see the appropriate User's Guide or other documentation.

You can use the MAC address filter to tell the AP which wireless clients are allowed or not allowed to use the wireless network. If a wireless client is allowed to use the wireless network, it still has to have the correct settings (SSID, channel, and security). If a wireless client is not allowed to use the wireless network, it does not matter if it has the correct settings.

This type of security does not protect the information that is sent in the wireless network. Furthermore, there are ways for unauthorized devices to get the MAC address of an authorized wireless client. Then, they can use that MAC address to use the wireless network.

User Authentication

You can make every user log in to the wireless network before they can use it. This is called user authentication. However, every wireless client in the wireless network has to support IEEE 802.1x to do this.

For wireless networks, there are two typical places to store the user names and passwords for each user.

- In the AP: this feature is called a local user database or a local database.
- In a RADIUS server: this is a server used in businesses more than in homes.

If your AP does not provide a local user database and if you do not have a RADIUS server, you cannot set up user names and passwords for your users.

Unauthorized devices can still see the information that is sent in the wireless network, even if they cannot use the wireless network. Furthermore, there are ways for unauthorized wireless users to get a valid user name and password. Then, they can use that user name and password to use the wireless network.

Local user databases also have an additional limitation that is explained in the next section.

Encryption

Wireless networks can use encryption to protect the information that is sent in the wireless network. Encryption is like a secret code. If you do not know the secret code, you cannot understand the message.

The types of encryption you can choose depend on the type of user authentication. (See [page 82](#) for information about this.)

Table 26 Types of Encryption for Each Type of Authentication

	NO AUTHENTICATION	RADIUS SERVER
Weakest	No Security	WPA
↑ ↓	WPA-PSK	
Strongest	WPA2-PSK	WPA2

1. Some wireless devices, such as scanners, can detect wireless networks but cannot use wireless networks. These kinds of wireless devices might not have MAC addresses.
2. Hexadecimal characters are 0, 1, 2, 3, 4, 5, 6, 7, 8, 9, A, B, C, D, E, and F.

For example, if the wireless network has a RADIUS server, you can choose **WPA** or **WPA2**. If users do not log in to the wireless network, you can choose no encryption, **WPA-PSK**, or **WPA2-PSK**.

Usually, you should set up the strongest encryption that every wireless client in the wireless network supports. For example, suppose the AP does not have a local user database, and you do not have a RADIUS server. Therefore, there is no user authentication. Suppose the wireless network has two wireless clients. Device A only supports WPA, and device B supports WPA and WPA2. Therefore, you should set up **WPA** or **WPA-PSK** in the wireless network.

Note: It is recommended that wireless networks use **WPA-PSK**, **WPA**, or stronger encryption. IEEE 802.1x and WEP encryption are better than none at all, but it is still possible for unauthorized devices to figure out the original information pretty quickly.

Note: It is not possible to use **WPA-PSK**, **WPA** or stronger encryption with a local user database. In this case, it is better to set up stronger encryption with no authentication than to set up weaker encryption with the local user database.

When you select **WPA2** or **WPA2-PSK** in your NBG6617, you can also select an option (**WPA/WPA-PSK Compatible**) to support WPA/WPA-PSK as well. In this case, if some wireless clients support WPA and some support WPA2, you should set up **WPA2-PSK** or **WPA2** (depending on the type of wireless network login) and select the **WPA/WPA-PSK Compatible** option in the NBG6617.

Many types of encryption use a key to protect the information in the wireless network. The longer the key, the stronger the encryption. Every wireless client in the wireless network must have the same key.

Guest WLAN

Guest WLAN allows you to set up a wireless network where users can access to Internet via the NBG6617 (**Z**), but not other networks connected to the **Z**. In the following figure, a guest user can access the Internet from the guest wireless network **A** via **Z** but not the home or company network **N**.

Note: The home or company network **N** and Guest WLAN network are independent networks.

Note: Only Router mode supports guest WLAN.

Figure 49 Guest Wireless LAN Network

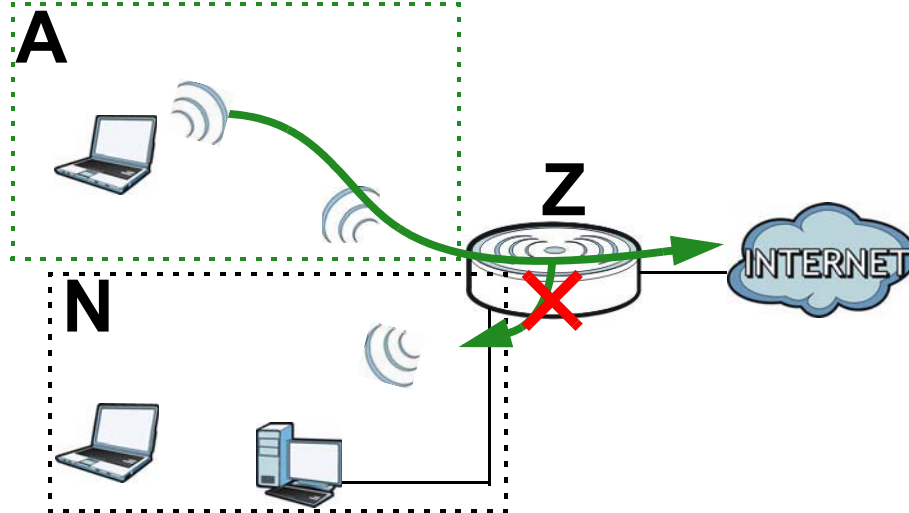

Guest WLAN Bandwidth

The Guest WLAN Bandwidth function allows you to restrict the maximum bandwidth for the guest wireless network. Additionally, you can also define bandwidth for your home or office network. An example is shown next to define maximum bandwidth for your networks (A is Guest WLAN and N is home or company network.)

Figure 50 Example: Bandwidth for Different Networks

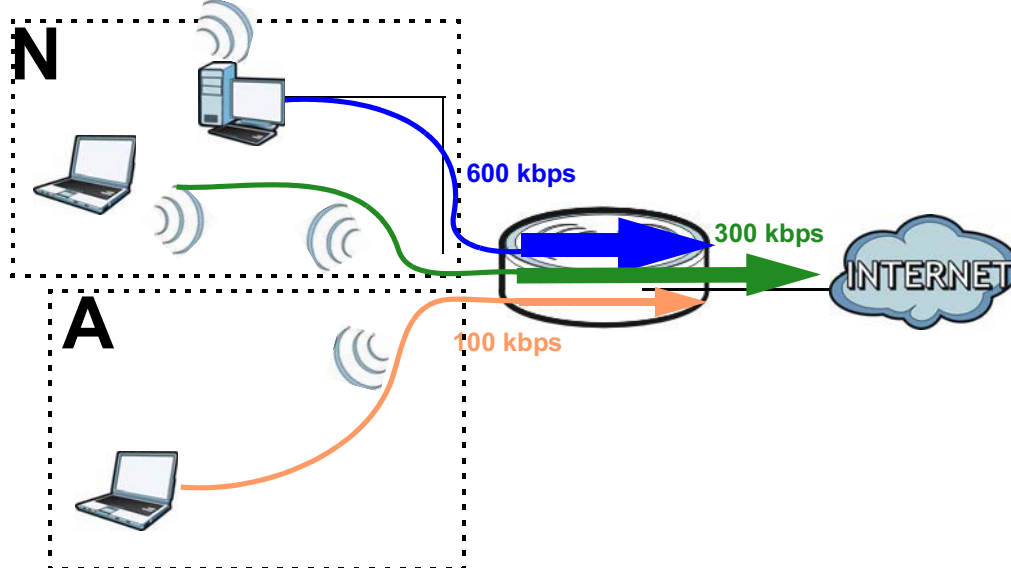

WPS

WiFi Protected Setup (WPS) is an industry standard specification, defined by the WiFi Alliance. WPS allows you to quickly set up a wireless network with strong security, without having to configure security settings manually. Depending on the devices in your network, you can either press a button (on the device itself, or in its configuration utility) or enter a PIN (Personal Identification

Number) in the devices. Then, they connect and set up a secure network by themselves. See how to set up a secure wireless network using WPS in the [Section 8.2 on page 49](#).

11.2 Wireless Screen

Use this screen to configure the SSID and wireless security of the NBG6617's default wireless LAN.

Note: If you are configuring the NBG6617 from a computer connected to the wireless LAN and you change the NBG6617's SSID, channel or security settings, you will lose your wireless connection when you press **Apply** to confirm. You must then change the wireless settings of your computer to match the NBG6617's new settings.

Click **Expert Mode > Wireless**.

Figure 51 Expert Mode > Wireless

The following table describes the general wireless LAN labels in this screen.

Table 27 Expert Mode > Wireless

LABEL	DESCRIPTION
Wireless Setup	
Band	Select the frequency band to set whether you want to apply the wireless and security settings to the default 2.4GHz or 5GHz wireless LAN.
Wireless LAN	Select Enable to activate the 2.4GHz and/or 5GHz wireless LAN. Select Disable to turn it off. You can enable or disable both 2.4GHz and 5GHz wireless LANs by using the WIFI button located on the rear panel of the NBG6617.

Table 27 Expert Mode > Wireless (continued)

LABEL	DESCRIPTION
Name (SSID)	The SSID (Service Set IDentity) identifies the Service Set with which a wireless client is associated. Enter a descriptive name (up to 32 printable characters found on a typical English language keyboard) for the wireless LAN.
Hide SSID	Select this check box to hide the SSID in the outgoing beacon frame so a station cannot obtain the SSID through scanning using a site survey tool.
Channel Selection	Select a channel from the drop-down list box. The options vary depending on the frequency band and the country you are in. This option is only available if Auto Channel Selection is disabled.
Operating Channel	This displays the channel the NBG6617 is currently using.
Channel Width	Select the wireless channel width used by NBG6617. A standard 20MHz channel offers transfer speeds of up to 144Mbps (2.4GHz) or 217Mbps (5GHZ) whereas a 40MHz channel uses two standard channels and offers speeds of up to 300Mbps (2.4GHz) or 450Mbps (5GHZ). Because not all devices support 40 MHz channels, select Auto 20/40MHz to allow the NBG6617 to adjust the channel bandwidth automatically. 40MHz (channel bonding or dual channel) bonds two adjacent radio channels to increase throughput. The wireless clients must also support 40 MHz. It is often better to use the 20 MHz setting in a location where the environment hinders the wireless signal. Select 20MHz if you want to lessen radio interference with other wireless devices in your neighborhood or the wireless clients do not support channel bonding.
802.11 Mode	If you set Band to 2.4GHz , you can select from the following: <ul style="list-style-type: none"> • 802.11b: allows either IEEE 802.11b or IEEE 802.11g compliant WLAN devices to associate with the NBG6617. In this mode, all wireless devices can only transmit at the data rates supported by IEEE 802.11b. • 802.11g: allows IEEE 802.11g compliant WLAN devices to associate with the Device. IEEE 802.11b compliant WLAN devices can associate with the NBG6617 only when they use the short preamble type. • 802.11bg: allows either IEEE 802.11b or IEEE 802.11g compliant WLAN devices to associate with the NBG6617. The NBG6617 adjusts the transmission rate automatically according to the wireless standard supported by the wireless devices. • 802.11n: allows IEEE 802.11n compliant WLAN devices to associate with the NBG6617. This can increase transmission rates, although IEEE 802.11b or IEEE 802.11g clients will not be able to connect to the NBG6617. • 802.11gn: allows either IEEE 802.11g or IEEE 802.11n compliant WLAN devices to associate with the NBG6617. The transmission rate of your NBG6617 might be reduced. • 802.11 bgn: allows IEEE802.11b, IEEE802.11g and IEEE802.11n compliant WLAN devices to associate with the NBG6617. The transmission rate of your NBG6617 might be reduced. If you set Band to 5GHz , you can select from the following: <ul style="list-style-type: none"> • 802.11a: allows only IEEE 802.11a compliant WLAN devices to associate with the NBG6617. • 802.11a/an: allows both IEEE802.11n and IEEE802.11a compliant WLAN devices to associate with the NBG6617. The transmission rate of your NBG6617 might be reduced. • 802.11a/an/ac: allows IEEE802.11n, IEEE802.11a and IEEE 802.11c compliant WLAN devices to associate with the NBG6617.
Security	

Table 27 Expert Mode > Wireless (continued)

LABEL	DESCRIPTION
Security Mode	Select WPA2-PSK to add security on this wireless network. The wireless clients which want to associate to this network must have same wireless security settings as this device. After you select to use a security, additional options appears in this screen. See Section 11.3 on page 87 for detailed information on different security modes. Or you can select No Security to allow any client to associate this network without authentication. Note: If the WPS function is enabled (default), only No Security and WPA2-PSK are available in this field.
Apply	Click Apply to save your changes back to the NBG6617.
Cancel	Click Cancel to reload the previous configuration for this screen.

See the rest of this chapter for information on the other labels in this screen.

11.3 Wireless Security

The screen varies depending on what you select in the **Security Mode** field.

11.3.1 No Security

Select **No Security** to allow wireless clients to communicate with the access points without any data encryption.

Note: If you do not enable any wireless security on your NBG6617, your network is accessible to any wireless networking device that is within range.

Figure 52 Expert Mode > Wireless > Security Mode: No Security

The screenshot shows the 'Wireless 2.4G' configuration page. At the top right are 'Apply' and 'Cancel' buttons. The page is divided into two sections: 'Wireless Setup' and 'Security'.
Wireless Setup includes:
 - Band: 2.4GHz (dropdown)
 - Wireless LAN: Enable Disable
 - Name (SSID): ZyXEL0C0D02 (text field)
 - Hide SSID:
 - Channel Selection: Auto Channel Selection (dropdown)
 - Operating Channel: Channel- (text field)
 - Channel Width: Auto (dropdown)
 - 802.11 Mode: 802.11bgn (dropdown)
Security section includes:
 - Security Mode: No Security (dropdown)
 - A note: Note: No Security and WPA2-PSK can be configured when WPS enabled.

The following table describes the labels in this screen.

Table 28 Expert Mode > Wireless > Security Mode: No Security

LABEL	DESCRIPTION
Security Mode	Choose No Security from the drop-down list box.
Apply	Click Apply to save your changes back to the NBG6617.
Cancel	Click Cancel to reload the previous configuration for this screen.

11.3.2 WPA-PSK/WPA2-PSK

Select **WPA-PSK** or **WPA2-PSK** from the **Security Mode** list.

Note: WPA-PSK is not available if you enable WPS before you configure WPA-PSK in the **Expert Mode > Wireless > Wireless** screen.

Figure 53 Expert Mode > Wireless > Security Mode: WPA-PSK/WPA2-PSK

The following table describes the labels in this screen.

Table 29 Expert Mode > Wireless > Security Mode: WPA-PSK/WPA2-PSK

LABEL	DESCRIPTION
Security Mode	Select WPA-PSK or WPA2-PSK to enable data encryption.
WPA-PSK Compatible	This field appears when you choose WPA2-PSK as the Security Mode . Check this field to allow wireless devices using WPA-PSK security mode to connect to your NBG6617.

Table 29 Expert Mode > Wireless > Security Mode: WPA-PSK/WPA2-PSK (continued)

LABEL	DESCRIPTION
PMF	Protected Management Frames (PMF) is a protection mechanism of action management frames. Check this field to allow wireless devices using the PMF protection mechanism to connect to your NBG6617.
Pre-Shared Key	WPA-PSK/WPA2-PSK uses a simple common password for authentication. Type a pre-shared key from 8 to 63 case-sensitive keyboard characters.
Group Key Update Timer	The Group Key Update Timer is the rate at which the AP sends a new group key out to all clients. The default is 3600 seconds (60 minutes).
Apply	Click Apply to save your changes back to the NBG6617.
Cancel	Click Cancel to reload the previous configuration for this screen.

11.3.3 WPA/WPA2

Select **WPA** or **WPA2** from the **Security Mode** list.

Note: WPA or WPA2 is not available if you enable WPS before you configure WPA or WPA2 in the **Expert Mode > Wireless > Wireless** screen.

Figure 54 Expert Mode > Wireless > Security Mode: WPA/WPA2

Wireless 2.4G [Apply] [Cancel]

Wireless Setup

Band : 2.4GHz ▾

Wireless LAN : Enable Disable

Name (SSID) : ZyXEL43D262

Hide SSID

Channel Selection : Channel-11 2462MHz ▾

Operating Channel : Channel-11

Channel Width : Auto 20/40 MHz ▾

802.11 Mode : 802.11bgn ▾

Security

Security Mode : WPA2 ▾

WPA Compatible

Group Key Update Timer : 3600 seconds

PMK Cache Period : 10 minutes

Pre-Authentication : Enable Disable

Authentication Server

IP Address : 192.168.2.3

Port Number : 1812

Shared Secret : 12345678

Session Timeout(0 or 60~) : 0 seconds

Note: No Security and WPA2-PSK can be configured when WPS enabled.

The following table describes the labels in this screen.

Table 30 Expert Mode > Wireless > Security Mode: WPA/WPA2

LABEL	DESCRIPTION
Security Mode	Select WPA or WPA2 to enable data encryption.
WPA Compatible	This check box is available only when you select WPA2-PSK or WPA2 in the Security Mode field. Select the check box to have both WPA2 and WPA wireless clients be able to communicate with the NBG6617 even when the NBG6617 is using WPA2-PSK or WPA2.
Group Key Update Timer	The Group Key Update Timer is the rate at which the AP (if using WPA-PSK/WPA2-PSK key management) or RADIUS server (if using WPA/WPA2 key management) sends a new group key out to all clients. The re-keying process is the WPA/WPA2 equivalent of automatically changing the WEP key for an AP and all stations in a WLAN on a periodic basis. Setting of the Group Key Update Timer is also supported in WPA-PSK/WPA2-PSK mode.
PMK Cache Period	This field is available only when you select WPA2 . Specify how often wireless clients have to resend usernames and passwords in order to stay connected. Enter a time interval between 10 and 999999 minutes. Note: If wireless client authentication is done using a RADIUS server, the reauthentication timer on the RADIUS server has priority.

Table 30 Expert Mode > Wireless > Security Mode: WPA/WPA2 (continued)

LABEL	DESCRIPTION
Pre-Authentication	This field is available only when you select WPA2 . Pre-authentication enables fast roaming by allowing the wireless client (already connecting to an AP) to perform IEEE 802.1x authentication with another AP before connecting to it. Select Enable to turn on preauthentication in WAP2. Otherwise, select Disable .
Authentication Server	
IP Address	Enter the IP address of the external authentication server in dotted decimal notation.
Port Number	Enter the port number of the external authentication server. You need not change this value unless your network administrator instructs you to do so with additional information.
Shared Secret	Enter a password (up to 127 alphanumeric characters) as the key to be shared between the external authentication server and the NBG6617. The key must be the same on the external authentication server and your NBG6617. The key is not sent over the network.
Session Timeout	The NBG6617 automatically disconnects a wireless client from the wireless and wired networks after a period of inactivity. The wireless client needs to send the username and password again before it can use the wireless and wired networks again. Some wireless clients may prompt users for a username and password; other clients may use saved login credentials. In either case, there is usually a short delay while the wireless client logs in to the wireless network again. Enter the time in seconds from 0 to 999999.
Apply	Click Apply to save your changes back to the NBG6617.
Cancel	Click Cancel to reload the previous configuration for this screen.

11.4 Guest Wireless Screen

This screen allows you to enable and configure multiple guest wireless network settings on the NBG6617.

You can configure up to four SSIDs to enable multiple BSSs (Basic Service Sets) on the NBG6617. This allows you to use one access point to provide several BSSs simultaneously. You can then assign varying security types to different SSIDs. Wireless clients can use different SSIDs to associate with the same access point.

Click **Expert Mode > Wireless > Guest Wireless**. The following screen displays.

Figure 55 Expert Mode > Wireless > Guest Wireless

#	Status	SSID	Security	Remaining time	Edit
1	⚪	ZyXEL_SSID1	No Security	0:0:0	Set
2	⚪	ZyXEL_SSID2	No Security	0:0:0	Set
3	⚪	ZyXEL_SSID3	No Security	9:59:44	Set

The following table describes the labels in this screen.

Table 31 Expert Mode > Wireless > Guest Wireless

LABEL	DESCRIPTION
Band	Use 2.4GHz or 5GHz to set up the NBG6617's guest Wi-Fi network.
#	This is the index number of each SSID profile.
Status	This shows whether the SSID profile is active (a yellow bulb) or not (a gray bulb).
SSID	An SSID profile is the set of parameters relating to one of the NBG6617's BSSs. The SSID (Service Set IDentifier) identifies the Service Set with which a wireless device is associated. This field displays the name of the wireless profile on the network. When a wireless client scans for an AP to associate with, this is the name that is broadcast and seen in the wireless client utility.
Security	This field indicates the security mode of the SSID profile.
Remaining time	If the user is currently not permitted to access the Internet, you can click the Set to allow access for a specified period of time. A screen then displays allowing you to set how long (in hours) the user is allowed to access the Internet. This field displays the amount of Internet access time that remains for each user before the NBG6617 blocks the user from accessing the Internet. 0:0:0 means there is no extra Internet access time.
Edit	Click the Edit icon to configure the SSID profile.

11.4.1 Guest Wireless Edit

Use this screen to edit an SSID profile. Click the **Edit** icon next to an SSID in the **Guest Wireless** screen. The following screen displays.

Figure 56 Expert Mode > Wireless > Guest Wireless > Guest Wireless Setup: Edit



The following table describes the labels in this screen.

Table 32 Expert Mode > Wireless > Guest Wireless > Guest Wireless Setup: Edit

LABEL	DESCRIPTION
Active	Select this to activate the SSID profile.
Name (SSID)	The SSID (Service Set Identity) identifies the Service Set with which a wireless client is associated. Enter a descriptive name (up to 32 printable characters found on a typical English language keyboard) for the wireless LAN.

Table 32 Expert Mode > Wireless > Guest Wireless > Guest Wireless Setup: Edit (continued)

LABEL	DESCRIPTION
Hide SSID	Select this check box to hide the SSID in the outgoing beacon frame so a station cannot obtain the SSID through scanning using a site survey tool.
Intra-BSS Traffic Blocking	A Basic Service Set (BSS) exists when all communications between wireless clients or between a wireless client and a wired network client go through one access point (AP). Intra-BSS traffic is traffic between wireless clients in the BSS. When Intra-BSS is enabled, wireless clients can access the wired network and communicate with each other. When Intra-BSS is disabled, wireless clients can still access the wired network but cannot communicate with each other.
WMM QoS	Check this to have the NBG6617 automatically give a service a priority level according to the ToS value in the IP header of packets it sends. WMM QoS (Wifi MultiMedia Quality of Service) gives high priority to voice and video, which makes them run more smoothly.
Enable Bandwidth Management for Guest WLAN	Select this to turn on bandwidth management for the Guest Wi-Fi network.
Maximum Bandwidth	Enter a number to specify maximum bandwidth the Guest Wi-Fi network can use.
Security Mode	Select WPA-PSK or WPA2-PSK to add security on this wireless network. The wireless clients which want to associate to this network must have same wireless security settings as this device. After you select to use a security, additional options appears in this screen. See Section 11.3 on page 87 for detailed information on different security modes. Or you can select No Security to allow any client to associate this network without authentication. Note: If the WPS function is enabled (default), only No Security and WPA2-PSK are available in this field.
Apply	Click Apply to save your changes back to the NBG6617.
Cancel	Click Cancel to reload the previous configuration for this screen.

11.5 MAC Filter Screen

The MAC filter screen allows you to configure the NBG6617 to give exclusive access to devices (**Allow**) or exclude devices from accessing the NBG6617 (**Deny**). Every Ethernet device has a unique MAC (Media Access Control) address. The MAC address is assigned at the factory and consists of six pairs of hexadecimal characters, for example, 00:A0:C5:00:00:02. You need to know the MAC address of the devices to configure this screen.

To change your NBG6617's MAC filter settings, click **Expert Mode > Wireless > MAC Filter**. The screen appears as shown.

Figure 57 Expert Mode > Wireless > MAC Filter

MAC Filter 2.4G Apply Cancel

Band :

SSID Select :

MAC Address Filter : Enable Disable

Filter Action : Allow Deny

MAC Filter Summary (Max Limit : 64)

#	MAC Address	Add/Delete
<input type="text" value="User Defined"/>	<input type="text" value="00:00:00:00:00:00"/>	<input type="button" value="+"/>
1	AC:AC:AB:CC:BA:AC	<input type="button" value="-"/>

The following table describes the labels in this menu.

Table 33 Expert Mode > Wireless > MAC Filter

LABEL	DESCRIPTION
Band	Select the frequency band to set whether you want to apply the wireless and security settings to the default 2.4GHz or 5GHz wireless LAN.
SSID Select	This shows the SSID for which you are configuring MAC filtering.
MAC Address Filter	Select to turn on (Enable) or off (Disable) MAC address filtering.
Filter Action	Define the filter action for the list of MAC addresses in the MAC Filter Summary table. Select Allow to permit access to the NBG6617, MAC addresses not listed will be denied access to the NBG6617. Select Deny to block access to the NBG6617, MAC addresses not listed will be allowed to access the NBG6617.
MAC Filter Summary (Max Limit : 64)	
#	This is the index number of the MAC address. Select Auto Detection to automatically detect the MAC address of the wireless station that are allowed or denied access to the NBG6617. Otherwise, select User define to enter the MAC address of the wireless station in the MAC Address field that are allowed or denied access to the NBG6617.
MAC Address	This field displays the MAC address of the wireless station. If you select User define in the # field, enter the MAC address(es) manually.
Add/Delete	Click <input type="button" value="+"/> to add the rule in the MAC filter summary table. Click <input type="button" value="-"/> to remove a rule.
Apply	Click Apply to save your changes back to the NBG6617.
Cancel	Click Cancel to reload the previous configuration for this screen.

11.6 Advanced Screen

Use this screen to allow wireless advanced features, such as the output power, RTS/CTS Threshold settings.

Click **Expert Mode > Wireless > Advanced**. The screen appears as shown.

Figure 58 Expert Mode > Wireless > Advanced

Advanced 2.4G		Apply	Cancel
Wireless Advanced Setup			
Band :	<input type="text" value="2.4GHz"/>		
RTS/CTS Threshold :	<input type="text" value="2346"/>	(256 ~ 2346)	
Fragmentation Threshold :	<input type="text" value="2346"/>	(256 ~ 2346)	
Intra-BSS Traffic :	<input type="radio"/> Enable <input checked="" type="radio"/> Disable		
Tx Power :	<input type="text" value="100%"/>		
<hr/>			
QoS Setup			
WMM QoS :	<input checked="" type="radio"/> Enable <input type="radio"/> Disable		
Note: When the wireless mode contains N mode, wmm support will be enabled automatically.			

The following table describes the labels in this screen.

Table 34 Expert Mode > Wireless > Advanced

LABEL	DESCRIPTION
Wireless Advanced Setup	
Band	Select the frequency band to set whether you want to apply the wireless and security settings to the default 2.4GHz or 5GHz wireless LAN.
RTS/CTS Threshold	Data with its frame size larger than this value will perform the RTS (Request To Send)/CTS (Clear To Send) handshake. This field is not configurable and the NBG6617 automatically changes to use the maximum value if you select 802.11n , 802.11an , 802.11gn or 802.11bgn in the Expert > Wireless screen.
Fragmentation Threshold	The threshold (number of bytes) for the fragmentation boundary for directed messages. It is the maximum data fragment size that can be sent. This field is not configurable and the NBG6617 automatically changes to use the maximum value if you select 802.11n , 802.11an , 802.11gn or 802.11bgn in the Expert > Wireless screen.
Intra-BSS Traffic	A Basic Service Set (BSS) exists when all communications between wireless clients or between a wireless client and a wired network client go through one access point (AP). Intra-BSS traffic is traffic between wireless clients in the BSS. When you Enable Intra-BSS, wireless clients can access the wired network and communicate with each other. When you Disable Intra-BSS, wireless clients can still access the wired network but cannot communicate with each other.
Tx Power	Set the output power of the NBG6617 in this field. If there is a high density of APs in an area, decrease the output power of the NBG6617 to reduce interference with other APs. Select one of the following 100% , 90% , 75% , 50% , 25% or 10% .
QoS Setup	
WMM QoS	Select Enable to have the NBG6617 automatically give a service a priority level according to the ToS value in the IP header of packets it sends. WMM QoS (Wifi MultiMedia Quality of Service) gives high priority to voice and video, which makes them run more smoothly. This field is not configurable and the NBG6617 automatically enables WMM QoS if you select 802.11n , 802.11an , 802.11gn or 802.11bgn in the Expert > Wireless screen.

Table 34 Expert Mode > Wireless > Advanced (continued)

LABEL	DESCRIPTION
Apply	Click Apply to save your changes back to the NBG6617.
Cancel	Click Cancel to reload the previous configuration for this screen.

11.7 WPS Screen

Use this screen to enable/disable WPS, view or generate a new PIN number and check current WPS status. To open this screen, click **Expert Mode > Wireless > WPS**.

Note: With WPS, wireless clients can only connect to the wireless network using the first SSID on the NBG6617.

Figure 59 Expert Mode > Wireless > WPS

WPS 2.4G
Apply
Cancel

WPS Setup

Band : 2.4GHz ▾

WPS : Enable Disable

PIN Code : Enable Disable

PIN Number : Generate

Click the Push Button to add WPS stations to wireless network. Push Button

Or input station's PIN number : Start

Note:

1. The Push Button Configuration requires pressing a button on both the station and AP within 120 seconds.
2. You may find the PIN number in the station's utility.

WPS Status

Status : Configured Release Configuration

802.11 Mode : 802.11bgn

SSID : ZyXEL43D27E

Security : WPA2-PSK

Note:

If you enable WPS, the UPnP service will be turned on automatically.

The following table describes the labels in this screen.

Table 35 Expert Mode > Wireless > WPS

LABEL	DESCRIPTION
WPS Setup	
Band	Select the frequency band to set whether you want to apply the wireless and security settings to the default 2.4GHz or 5GHz wireless LAN.
WPS	Select Enable to turn on the WPS feature. Otherwise, select Disable .
PIN Code	Select Enable and click Apply to allow the PIN Configuration method. If you select Disable , you cannot create a new PIN number.
PIN Number	This is the WPS PIN (Personal Identification Number) of the NBG6617. Enter this PIN in the configuration utility of the device you want to connect to the NBG6617 using WPS. The PIN is not necessary when you use WPS push-button method. Click Generate to generate a new PIN number.
Push Button	Use this button when you use the PBC (Push Button Configuration) method to configure wireless stations's wireless settings. Click this to start WPS-aware wireless station scanning and the wireless security information synchronization.
Or input station's PIN number	Use this button when you use the PIN Configuration method to configure wireless station's wireless settings. Type the same PIN number generated in the wireless station's utility. Then click Start to associate to each other and perform the wireless security information synchronization.
WPS Status	
Status	This displays Configured when the NBG6617 has connected to a wireless network using WPS or when WPS Enable is selected and wireless or wireless security settings have been changed. The current wireless and wireless security settings also appear in the screen. This displays Unconfigured if WPS is disabled and there are no wireless or wireless security changes on the NBG6617 or you click Release Configuration to remove the configured wireless and wireless security settings.
Release Configuration	This button is only available when the WPS status displays Configured . Click this button to remove all configured wireless and wireless security settings for WPS connections on the NBG6617.
802.11 Mode	This is the 802.11 mode used. Only compliant WLAN devices can associate with the NBG6617.
SSID	This is the name of the wireless network (the NBG6617's first SSID).
Security	This is the type of wireless security employed by the network.
Apply	Click Apply to save your changes back to the NBG6617.
Cancel	Click Cancel to reload the previous configuration for this screen.

11.8 Scheduling Screen

Use this screen to set the times your wireless LAN is turned on and off. Wireless LAN scheduling is disabled by default. The wireless LAN can be scheduled to turn on or off on certain days and at certain times. To open this screen, click **Expert Mode > Wireless > Scheduling**.

Figure 60 Expert Mode > Wireless > Scheduling

The following table describes the labels in this screen.

Table 36 Expert Mode > Wireless > Scheduling

LABEL	DESCRIPTION
Band	Select the frequency band to set whether you want to apply the wireless and security settings to the default 2.4GHz or 5GHz wireless LAN.
Wireless LAN Scheduling	Select Enable to activate the wireless LAN scheduling feature. Select Disable to turn it off.
Internet Access Schedule	The y-axis shows the time period in days. The x-axis shows the time period in hours. Click Select All or click gray blocks to specify days and times to turn the Wireless LAN on or off. If you click Select All you can not select any specific days and times. Click Clean All to remove all the wireless LAN scheduling.
Apply	Click Apply to save your changes back to the NBG6617.
Cancel	Click Cancel to reload the previous configuration for this screen.