

**D-Link**<sup>®</sup> CORPORATION

---

**D-Link**<sup>®</sup>

**DVG-6008S  
VOIP Gateway**

**User Manual**

Version 1.0



## Contents

<b>1. Introduction.....</b>	<b>3</b>
Product Overview .....	3
Hardware Description.....	4
<b>2. Installation and Applications .....</b>	<b>6</b>
Network Interface .....	6
Gateway Assigned with a Public IP Address .....	6
Gateway in a NAT network.....	6
Gateway assigned with a Public IP Address and serving as an IP sharing device.....	7
Telephone Interface Description.....	8
Example for Line Ports : .....	8
<b>3. Setting the Gateway through IVR.....</b>	<b>9</b>
IVR (Interactive Voice Response) .....	9
IVR Functions Table: .....	11
IP Configuration Settings—Setting IP Configuration of WAN Port.....	13
Recorded Voice File .....	14
<b>4. Setting a Gateway with WEB Browser .....</b>	<b>16</b>
Network Settings (WAN) .....	16
Network Settings (LAN).....	21
QoS Settings .....	23
NAT/DDNS .....	24
Telephony Settings .....	26
SIP.....	30
Calling Features .....	34
Advanced Options.....	35
Line Settings.....	36
Codec .....	37
Fax Settings.....	37
Digit Map .....	39
Phone Book.....	40
Speed Dial .....	40
Caller Filter .....	41
ACL for Management .....	41
CDR Settings.....	41
Language .....	42
Transit Call Control.....	42
Long-Distance Control Table.....	43
Long Distance Exception Table.....	43
CPT/Cadence Settings.....	44
Busy Tone Cadence Measurement.....	44
UDT Detection .....	44
Save Settings .....	49
System Information .....	50
RTP Packet Summary.....	51
STUN Inquiry.....	51
Ping Test.....	51
SNMP .....	52
NTP .....	52
Backup/Restore.....	52

Provision Settings.....	53
System Operations (Save Settings).....	53
Software Upgrade .....	54
Logout .....	54
<b>5. IP Sharing Functions.....</b>	<b>55</b>
<b>6. Coding Principle .....</b>	<b>58</b>
Instruction.....	58
Dialed Number Processing Flow.....	58
<b>7. Advanced Feature .....</b>	<b>60</b>
Static Route※ .....	60
RIP(Routing Information Protocol) ※.....	60
Port filtering .....	61
IP Filtering .....	61
MAC Filtering.....	62
Virtual Server.....	62
DMZ.....	62
URL Filter※.....	63
Special Applications※ .....	63
DoS Prevention Settings※ .....	64

# 1. Introduction

---

## Product Overview

The stand-alone VoIP Gateway carries both voice and facsimile over the IP network. It supports SIP industry standard call control protocol to be compatible with free registration services or VoIP service providers' systems. It works in two different modes: UA (User Agent) or Server. As a standard user agent, it is compatible to all well-known Soft Switches and SIP proxy servers. While running the optional server software, the gateway can be configured to establish a private VoIP network over the Internet without a 3<sup>rd</sup> party SIP Proxy Server.

The gateway can be seamlessly integrated to existing network by connecting to a phone set, PBX, key telephone system, fax machine or PSTN line. With only a broadband connection such as ADSL bridge/router, Cable Modem or leased line router, it allows you to gain access to voice and fax services over the IP in order to reduce the cost of international and long distance calls.

In addition, the in-built 4 ports Ethernet switch supports comprehensive Internet gateway functions to accommodate other PCs or IP devices to share the same broadband stream. QoS function allows voice and data traffic to flow through where voice traffic is transmitted in the highest priority. With TOS bit enabled, it guarantees voice packets to have first priority to pass through a TOS enabled router.

With the support of DDNS, it makes the gateway reachable by its domain name where the ISP dynamically assigns the IP address. It helps users to host a web site or mail server in a PPPoE or DHCP network. By enabling the CDR function & setting up a simple server, administrators are allowed to log in and view all call records such as call duration, time and date of calls and latency.

The gateway can be assigned with a fixed IP address or by DHCP, PPPoE. It adopts the G.711, G.726, G.729A or G.723.1 voice compression format to save the network bandwidth while providing real-time and toll quality voice. In addition, in the event that the power supply fails or Internet connection is lost, the gateway can automatically divert the FXS end to the PSTN network on the FXO port so users can still use the conventional PSTN line to make calls. This feature is especially useful while dialing emergency calls (i.e. 911)

## Hardware Description

### Front Panel

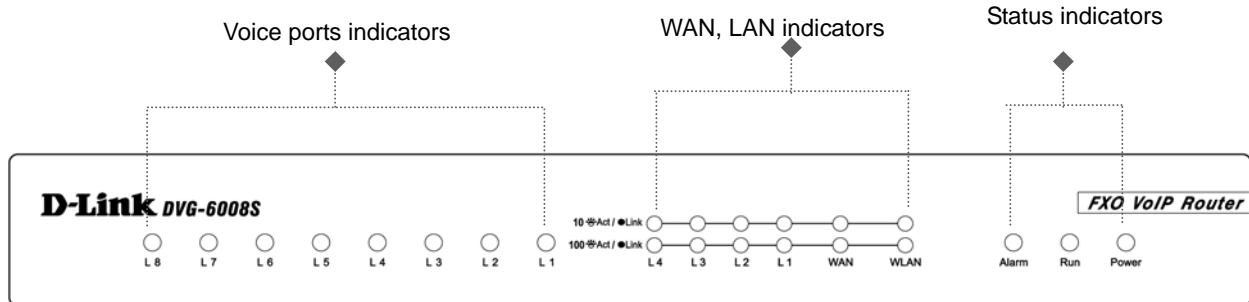

- Power Indicator: Green light indicates a normal power supply.
  - Run Indicator: Blinking green light indicates normal operation.
  - Alarm Indicator: When the system starts up, the red light will blink. It also indicates the gateway's abnormal operation.
  - L1 – L8 stands for Port 1 – Port 8: Connect to your original telephone line on the wall jack with RJ-11 cable.
  - WAN stands for the WAN Port Indicator.
  - L1 – L4 stands for the LAN Port Indicator.
- ✓ When starting up the system, the Alarm, Run, and Power indicators will light up. After about 40 seconds, the Alarm indicator will go off, the Run indicator will blink in green, and the Power indicator will stay green under normal operational conditions. If the Alarm indicator continues to blink, it means the system is currently communicating with ISP and has yet to obtain an IP address.
- ✓ When the WAN is connected, the WAN indicator will light up in green and if data is being transmitted over the Internet, the indicator blinks in green and orange.

#### Restore to factory default: (IP address, User's Name and Password)

- (1) Pull off the power plug.
- (2) Press reset (do not let go of the reset button).
- (3) Plug the plug back into the socket (do not let go of the reset button).
- (4) Let go of the reset button after 6 seconds. Factory settings will be restored.

**NOTE 1:** Do not connect FXS ports to each other. Also, do not connect any FXS port directly to a PSTN line or internal PBX. These may cause damage to FXS.

**NOTE 2:** Please use the power adapter comes with VoIP Gateway. If using adapters other than the one comes with VoIP Gateway, it may cause problems and will affect the warranty of the product.

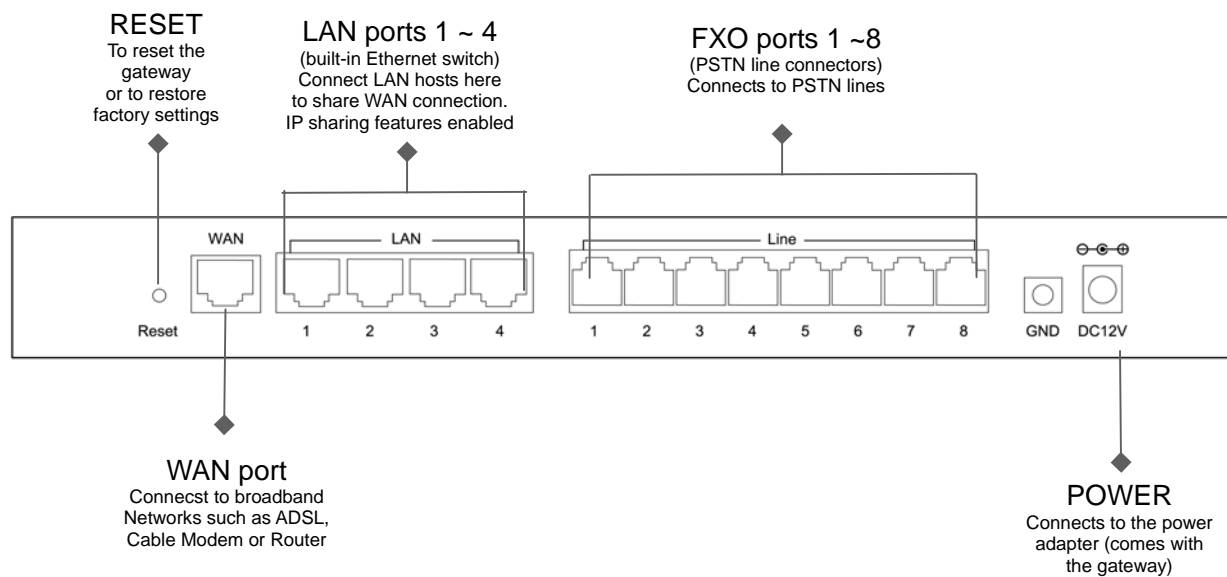
**Rear Panel****DVG-6008S Model**

## 2. Installation and Applications

---

### Network Interface

The network interface is divided into 3 basic modes as described below:

- Gateway can be assigned with a Public IP Address
- Gateway can be built under the existing NAT
- Gateway can be assigned with a Public IP address and serves as an IP sharing router.

### Gateway Assigned with a Public IP Address

The gateway will have a Public IP address for Internet connection regardless of whether it is a static IP address, DHCP (using a Cable Modem), or PPPoE (Dialup / ADSL).

Gateway IP Settings	Need to be set up as static IP, DHCP, or PPPoE	
NAT/STUN Settings	Unnecessary (Disabled)	
DDNS Settings	Unnecessary (Disabled)	

### Gateway in a NAT network

The gateway uses a virtual IP address and the IP sharing function of other systems to connect to the Internet.

LAN IP address of IP sharing	Please avoid IP address 192.168.0.1-192.168.8.254 (You may need to change the settings of IP sharing or change SIP series Gateway LAN Port IP address)	
Gateway IP Settings	Set as static IP address, and assign the LAN IP address of the IP sharing to the Default Gateway.	
NAT /STUN Settings Please refer to P. 29 for the Use NAT.	Enable	<p>If the WAN of the IP sharing device has static IP address, then the NAT IP address is set as the Public IP address of the IP sharing.</p> <p>If the WAN of the IP sharing device uses a dynamic IP address, then it has to comply with the DDNS settings. When using NAT, you must enter the URL (Uniform Resource Locator) that is registered to the DDNS server.</p>
DDNS Settings Please refer to P. 29 for the DDNS Settings	The WAN of the IP sharing device has a static IP address.	Disabled
	The WAN of the IP sharing device has a dynamic IP address.	Enabled: enter the registered URL (Uniform Resource Locator) into the network settings -> under NAT



### Gateway assigned with a Public IP Address and serving as an IP sharing device

The gateway will have a Public IP address regardless of whether it is a static IP application, DHCP (using a Cable Modem), or PPPoE (To connect to your ADSL account), which can then use the functions of built-in IP sharing function to allow other PCs to be on-line at the same time.

Gateway IP Settings	Need to be set up as static IP, DHCP, or PPPoE	
NAT/STUN Settings	Unnecessary (Disabled)	
DDNS Settings	Unnecessary (Disabled)	
For settings at PC end, please refer to section "IP sharing functions"	PC uses a static IP address ranging from: 192.168.8.1-192.168.8.253 Subnet Mask : 255.255.255.0 Default Gateway : 192.168.8.254	

## Telephone Interface Description

### Example for Line Ports :

#### Line Ports connecting directly to the Telephone Line of a PSTN

P1-P4 is FXO interfaces and can all be connected to a PSTN to serve as a bridge between the PSTN and other VoIP telephones. The system also allows a call to be made from a traditional telephone line to connect with a user behind the Gateway.

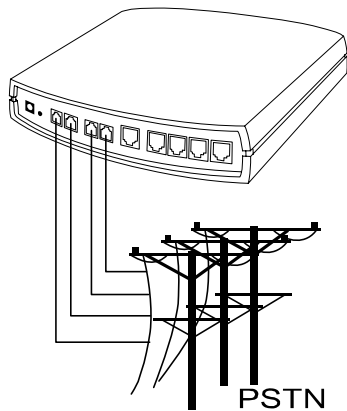

#### Integrating Line Ports with PBX

P1-P4 is FXO interfaces and can be connected with PBX extension lines (exclusively for analog interface, not applicable for digital type).

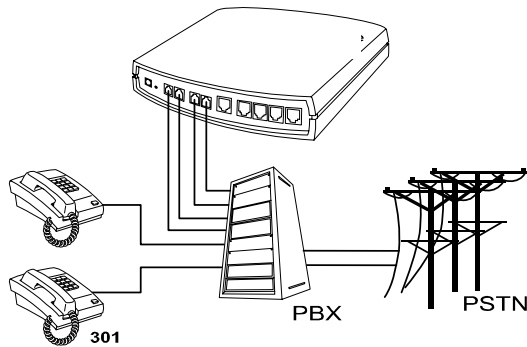

## 3. Setting the Gateway through IVR

---

VoIP transmits voice data (packet) via the Internet to achieve telecommunications. This means that the telecommunication quality is closely related to the whole network environment. If any one of the telecommunicating parties has insufficient bandwidth or frequent packet loss, the telecommunication quality will be poor. Therefore, an excellent telecommunication can only be created when Gateway is connected to the Internet and when network environment is stable.

### Preparation

- Install the Gateway according to instructions. Connect the power supply, telephone set, telephone cable, and network cable properly as described in Chapter 2.
- If a static IP is used, confirm the desired IP settings of the WAN Port (IP address, Subnet Mask, and Default gateway). Please contact your local Internet Service Provider (ISP) if you have any questions.
- If using dialup ADSL (PPPoE) for network connection, confirm the dialup account number and password.
- If users wish to build Gateway under the NAT, Gateway WAN Port IP address and LAN Port should not use the same range. This is to avoid phone failures.

### Basic Settings of a Gateway

- IP Settings— Connecting Gateway to the Internet.
- Telephone Number of Gateway Phone Number (   Gateway and SIP Prefix Number).
- Using **Phone Book** or **Phone Book manager**

#### **Please refer to Section 6 for Basic Dialing Method**

Gateway provides two setting modes:

1. Telephone IVR Setting.
2. Browser Setting.

The IVR provides basic query and setting functions, while the browser provides a full setting function.

### IVR (Interactive Voice Response)

Gateway provides convenient IVR functions. Users only need to pick up a handset and enter the function code for the query and setting without using a PC.

**NOTE: After finishing the settings, make sure the new settings are saved. This is so that the new settings will take effect after the system is restarted.**

## Instructions

- FXS Port: When you have set the password in WEB-GUI with English character. To access GW IVR function is different. Instead of \*\*[password]#
. You should press **\*\*\*[password]#**. The character to number conversion can be acquired from PPPoE Character Conversion Table.- FXO Port: to use IVR functions, dial the phone number of FXO Port using an external line. You will hear the instruction “enter value”, and then enter a PIN number. The factory default code is blank. Enter **\*\*\*#** as above. You are now in IVR setting mode.

**Example:** The factory default code is blank. Enter **\*\*\*#**. You are now in IVR setting mode, enter the desired code. E.g.: if the code is **1234**, then enter **\*\*\*1234#**. Or If your password is **abc123** then you access IVR by pressing **\*\*\*414243010203#**

- Once the first setting or query has been completed, you will hear a dial tone. Then use the same procedure to make a second query or setting. To exit IVR mode, simply hang up the phone.

Example: enter **\*\*\*#** (You are now in IVR mode) → enter **101** (to query IP address) → the system responds with an IP address → you can continue with more settings or queries: enter **111** (to set IP address) → enter **192\*168\*1\*2** (IP number).

## Save Settings

After entering IVR mode, dial **509** (Save Settings). Wait for about 3 seconds and after hearing a confirmation tone “1”, hang up the phone. Please reboot the Gateway to enable the new settings.

### To inquire about current Gateway’s WAN Port IP address

After entering IVR mode, dial **101**. The system will repeat the current WAN Port IP address. If the system does not repeat the IP address, it indicates that the Gateway is not currently connected to the Internet. Please check if the cable connection, account number, and password are correct.

### Software Upgrades

IVR provides online upgrades. Once in IVR mode, enter “209” and you will hear “Enter Value“. Enter your IP address followed by “#” (i.e. : **61\*30\*25\*89#**). Then you will hear a second “Enter Value“. Enter the Listen Port Number followed by “#”(i.e.: **6001#**). For information about upgrading, please ask your agent.

## IVR Functions Table:

Function Code	Description	Example
111/101	WAN Port IP address Set/Query	Use in conjunction with function code <b>114</b> , select 1 for a Static IP function.
112/102	WAN Port Subnet Mask Set/Query	
113/103	WAN Port Default Gateway Set/Query	
114/104	Current Network IP Access Set/Query (1: Static IP, 2.DHCP, 3.PPPoE)	
115/105	DNS IP address Set/Query	
116/106	Phone books manager IP address Set/Query	Must use 116/106, 117/107 in conjunction with each other.
117/107	Set/Query whether or not to use Public Telephone Book (0: Disable 1:Enable)	
199/099	Set/Query whether or not this Gateway acts as the phone books manager (0: Disable 1: Enable)	
066	Querying the connection to Phone books manager	
118	Restart	
121	Setting PPPoE Account	Use in conjunction with function code <b>114</b> , select 3 for a PPPoE function
122	Setting PPPoE Password	
123	Setting NAT IP address	Must use 123 and 124 in conjunction with each other.
124	Uses NAT (0: Disable 1: Enable)	
151/141	Register to Proxy Server Set/Query (0: Disable 1: Enable)	
152/142	Proxy Server IP address Set/Query	
153/143	Proxy Server Port Set/Query	
125	Set Proxy Server account	
126	Set Proxy Server password	
154/144	Uses STUN Set/Query (0: Disable 1: Enable)	
155/145	STUN IP address Set/Query	
156/146	STUN Port Set/Query	
311/301		
312/302		
131/132		
133	Saving greeting message	

<b>Function Code</b>	<b>Description</b>	<b>Example</b>
211/201	Set/Query International Prefix code	Prefix dialed before making an international call e.g. 002 and 005.
212/202	Set/Query Country Code	Setting country code, e.g. 886
213/203	Set/Query Area Prefix Code (Long-Distance Prefix Code)	Prefix dialed before making a long-distance call e.g. 0.
214/204	Set/Query Area Code	eg. "2" for Node B area.
215/205	Set/Query Gateway Telephone Number (Representative Number)	
216/206	Set/Query the extension number of Line 1.	
217/207		
109	Restoring factory default IP address configuration	A static IP address for WAN Port IP : 192.168.1.2 Mask : 255.255.255.0 Gateway : 192.168.1.254
409	Restoring factory default settings	
509	Save settings	
900	Setting IVR and the language used on the Web GUI (1: English, 2: Traditional Chinese, 3: Simplified Chinese)	
209	Soft Upgrade	

## IP Configuration Settings—Setting IP Configuration of WAN Port

### Static IP Settings

**NOTE:** Complete static IP settings should include a static IP (Option 1 under **114**), IP address (**111**), Subnet Mask (**112**), and Default Gateway (**113**). Please contact your local Internet Service Provider (ISP) if you have any questions.

Function	Command
Select a Static IP	<ul style="list-style-type: none"> <li>After entering IVR mode, dial 114.</li> <li>After hearing “Enter value”, dial 1 (to select static IP)</li> </ul>
IP address Settings	<ul style="list-style-type: none"> <li>After entering IVR mode, dial 111. After hearing “Enter value”, enter your IP address, followed by “#”.</li> </ul> <p>Example: If the IP address is 192.168.1.200, dial 192*168*1*200#.</p>
Subnet Mask Settings	<ul style="list-style-type: none"> <li>After entering IVR mode, dial 112. After hearing “Enter value”, enter your subnet mask, followed by “#”.</li> </ul> <p>Example: If the mask value is 255.255.255.0, dial 255*255*255*0#.</p>
Default Gateway Settings	<ul style="list-style-type: none"> <li>After entering IVR mode, dial 113. After hearing “Enter value”, enter your default gateway’s IP address, followed by “#”.</li> </ul> <p>Example: If the Default Gateway is 192.168.1.254, dial 192*168*1*254#.</p>
Save Settings and Restart	<ul style="list-style-type: none"> <li>To save settings, dial <b>509</b> (Save Settings). After hearing “one”, dial <b>118</b> to restart the system. Wait for about 40 seconds for the system to restart, and then enter <b>101</b> to check if the IP address is retained. If the IP address is not repeated, it indicates that Gateway has not been properly connected, please check if the cable connection, account, or password are correct.</li> </ul>

### Dynamic IP (DHCP) Settings

After entering IVR mode, dial **114**.

After hearing “Enter value”, dial 2 (to select DHCP).

Saving settings –press **509** (Save Settings). After hearing “one”, dial **118** to restart the system. After the system is restarted, press **101** to check if the IP address is retained.

**If the system does not repeat the IP address, it indicates Gateway has not been properly connected to the Internet. Please check the cable connection.**

## ADSL PPPoE Settings

**NOTE: Complete PPPoE settings should include: Select PPPoE (Option 3 of 114), PPPoE account (121) and PPPoE password (122).**

Please contact your local Internet Service Provider (ISP) if you have any questions.

### Select a PPPoE

- After entering IVR mode, dial 114.
- After hearing "Enter value", dial 3 (to select PPPoE).

### PPPoE Account Settings

- After entering IVR mode, dial 121.
- After hearing "Enter value", enter the account number, followed by "#".

Example: If the account is "84943122 @ hinet.net", please enter 080409040301020271484954456072544560#.

**Please note that it is necessary to enter two digits for each character/number; for example, enter "01" for "1" and "11" for "A".**

### PPPoE Password Setting

- After entering IVR mode, dial 122 after hearing "enter value" followed by "#".

Example: If the password is "3ttixike", please enter "03 60 60 49 64 49 51 45#".

### Save Settings and Restart

To save settings, dial 509 (Save Settings). The system will save the settings. Please restart the system. Wait for about 40 seconds for the system to restart, and then enter 101 to check if the IP address is retained. If the IP address is not repeated, it indicates that Gateway has not been properly connected, please check if the cable connection, account, or password are correct.

## Recorded Voice File

- The gateway allows users to record their incoming call greeting messages, when calling via FXO.
- After entering IVR mode, dial 132. After hearing "Enter value", record the incoming call greeting message. To end recording, simply hang up.
- After recording, to listen to the recorded message, press 131. Press 133 to save the message.





## 4. Setting a Gateway with WEB Browser

---

The gateway allows users to make settings using a web browser. After opening a browser, enter Gateway's IP address as the website address in order to enter the Web configuration screen as shown in the following diagram.

You can also enter "101" from the handset to inquire about the current WAN Port IP address. The factory default LAN Port IP address is 192.168.8.254.

### Instructions

- Open an Internet browser.
- Enter gateway's WAN Port IP address in the website address area (If the PC is connected to the LAN Port, enter the LAN Port IP address. The default is 192.168.8.254)
- The following registration screen will appear (The factory default settings for **Login ID and Password are left blank**).
- Change the default settings of Administrator's Name, Password and Web UI Login ID, Password in **Advanced Options**.
- After completing and confirming the settings, some of the settings will take effect immediately. But network related settings would take effect after the gateway is restarted. Please go to **System Operation** to save the settings before restarting the system.

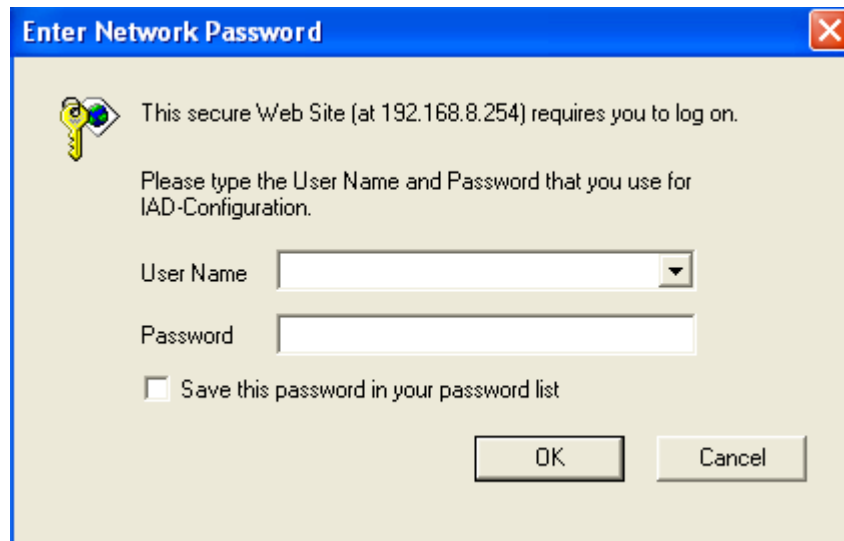

The screenshot shows a dialog box titled "Enter Network Password". It contains a key icon and the text: "This secure Web Site (at 192.168.8.254) requires you to log on. Please type the User Name and Password that you use for IAD-Configuration." Below this text are two input fields: "User Name" (with a dropdown arrow) and "Password". There is also a checkbox labeled "Save this password in your password list". At the bottom right, there are "OK" and "Cancel" buttons.

The gateway doesn't allow multiple people to configure the gateway at same time. If a user logs into the system, other users from different IP addresses cannot login at the same time. Please remember to logout or restart the system if not using the web configuration function.

### Network Settings (WAN)

The network settings are used to set the gateway's communication ports, IP configurations, and Phone Books Manager IP etc.

Network Settings (WAN)	
Current WAN IP Address	192.168.1.2
Listen Port UDP [1 - 65535]	5060
RTP Starting Port UDP [1 - 65500]	9000
<input type="radio"/> DHCP	
Static IP <input checked="" type="radio"/>	<input type="text" value="192.168.1.2"/> <input type="text" value="255.255.255.0"/> <input type="text" value="192.168.1.254"/>
PPPoE <input type="radio"/>	<input type="text" value=""/> <input type="text" value=""/> <input type="text" value=""/>
PPTP <input type="radio"/>	<input type="text" value=""/> <input type="text" value=""/> <input type="text" value=""/> <input type="text" value=""/> <input type="text" value=""/>
BigPond Cable <input type="radio"/>	<input type="text" value=""/> <input type="text" value=""/> <input type="text" value=""/> <input type="text" value=""/>
Domain Name Server Assignment	<input type="radio"/> Auto <input checked="" type="radio"/> Manual
Domain Name Server (Primary) IP	<input type="text" value="168.95.1.1"/>
Domain Name Server (Secondary) IP	<input type="text" value=""/>
Factory Default MAC Address	<input type="text" value="00AA8BCCDD00"/> <input type="button" value="Restore"/>
Your MAC Address	<input type="text" value="00DC295FC915"/> <input type="button" value="Clone"/>
Current MAC Address	<input type="text" value=""/>
Enable Phone Book Manager Server	<input type="checkbox"/> <input type="button" value="Clients List"/>
Share Phone Book to Clients	<input type="checkbox"/>
TTL (Expire time: mins) [1 - 60]	<input type="text" value="1"/>
Register to Phone Book Manager	<input type="checkbox"/>
Gateway Name for Phone Book Manager	<input type="text" value=""/>
Phone Book Manager Login Password	<input type="text" value=""/>
Confirm Password	<input type="text" value=""/>
Phone Book Manager IP/Domain	<input type="text" value="192.168.1.1"/>
Phone Book Manager Server Listen Port [1 - 65535]	<input type="text" value="1690"/>
LAN interface mode	
<input checked="" type="radio"/> Router <input type="radio"/> Bridge	
Network Settings (LAN)	
LAN IP / LAN default Gateway	<input type="text" value="192.168.8.254"/>
Subnet mask	<input type="text" value="255.255.255.0"/>
DHCP Server	
Enable DHCP Server	<input checked="" type="checkbox"/>
IP Pool Starting Address	<input type="text" value="192.168.8.1"/>
IP Pool Ending Address	<input type="text" value="192.168.8.250"/>
Lease Time [1 - 9999 hours]	<input type="text" value="1"/>
Domain Name Server Assignment	<input checked="" type="radio"/> Auto <input type="radio"/> Manual
Domain Name Server (Primary) IP	<input type="text" value=""/>
Domain Name Server (Secondary) IP	<input type="text" value=""/>
Port of Web Access from WAN [0=disable, 1 - 65535]	<input type="text" value="80"/>
Enable Web UI	<input checked="" type="checkbox"/>
Enable Telnet Service	<input checked="" type="checkbox"/>

- Listen Port UDP: It is not necessary to change the protocol of the communication port used by the gateway.
- RTP Starting Port UDP: The initial value of port number for transmitting voice data among Gateway(s). Each line requires 2 ports (RTP/RTCP). It is not necessary to change these.

**For example:** If the starting port is 9000, then Line 1 is using 9000(RTP) and 9001(RTCP),

and Line 2 is using 9002 and 9003, and so forth.

## IP Configuration (Setting WAN Port)

There are four methods of obtaining a WAN port IP address:

1. Static IP
2. DHCP, means a Dynamic IP (Cable Modem)
3. PPPoE (Dialup ADSL)
4. PPTP.

Using the DHCP and PPPoE for obtaining an IP address may vary. If not familiar with the network connection, please contact your local ISP.

## Setting Dynamic IP (DHCP)



Click "DHCP" to obtain a Dynamic IP address, then click the "Accept" button at the bottom of the screen. Save the settings: Click **System Operation** to select "Save Settings", "Restart", and then click the "Accept" button. Wait for a while (about 40 seconds), and the system will obtain the related IP value from the DHCP Server.

**NOTE: After the system has obtained a new IP address, if using WAN Port to enter the Web Configuration Screen, a new IP address has to be used. The same applies to the following two settings.**

## Setting Static IP

Static IP <input checked="" type="radio"/>	IP address	192.168.1.2
	Subnet mask	255.255.255.0
	Default Gateway IP	192.168.1.254

Select "Static IP" and enter the IP address, Subnet Mask and Default Gateway values. Then click the "Accept" button at the bottom of the screen.

Save the settings, and then restart the system. Wait for about 40 seconds for the system to restart.

## ADSL PPPoE Settings

PPPoE <input checked="" type="radio"/>	PPPoE Account	<input type="text"/>
	PPPoE Password	<input type="text"/>
	Confirm Password	<input type="text"/>

Select "PPPoE" Enter the Account Number, Password and Reenter Password to confirm. Then click the "Accept" button at the bottom.

Save the settings, and then restart the system. The system will take about 49 seconds to restart.

**PPTP**✘

PPTP <input checked="" type="radio"/>	IP address	<input type="text"/>
	Subnet mask	<input type="text"/>
	PPTP Server	<input type="text"/>
	PPTP ID	<input type="text"/>
	PPTP Password	<input type="text"/>
		<input type="text"/>
	Confirm Password	<input type="text"/>

Select "PPTP" and enter the IP Address, Subnet mask, PPTP Server, PPTP ID and Password. Then click the "Accept" button at the bottom.

### BigPond (for Australia use only)

BigPond Cable <input checked="" type="radio"/>	User Name	<input type="text"/>
	BigPond Cable Password	<input type="text"/>
		<input type="text"/>
	Confirm Password	<input type="text"/>
	Login Server	<input type="text"/>

Click "BigPond Cable" Enter User Name and Password. Login Server is optional. Then click the "Accept" button at the bottom.

### (DNS) Settings

Domain Name Server Assignment	<input type="radio"/> Auto <input checked="" type="radio"/> Manual
Domain Name Server (Primary) IP	<input type="text" value="168.95.1.1"/>
Domain Name Server (Secondary) IP	<input type="text"/>

Domain Name Server (DNS): While a gateway is accessing another gateway or computer with a hostname, it will look up the IP address from the DNS provided by ISP. The ISP whilst negotiating with PPPoE or DHCP usually assigns the DNS information. In the case that the DNS is not assigned automatically or WAN port is assigned with a static IP address, the DNS information must be assigned manually.

Auto : Gateway learns primary & secondary addresses from ISP's DHCP server or PPPoE server.

Manual : Enter the primary & secondary addresses manually. Please be sure the IP addresses are correct otherwise the gateway will not be able to access hosts with its hostname.

### Clone MAC

Factory Default MAC Address	00AABBCCDD00	Restore
Your MAC Address	000C295FC915	Clone
Current MAC Address		

Some Internet Service Providers (ISP) assigns the bandwidth via the MAC (Media Access Control) Address. You can click the " Clone" button to copy the MAC address of the Ethernet Card installed in the computer used to configure the device. It is only necessary to fill in the field if required by your ISP. The "Your MAC Address" will be blank as you log in through WAN port.

## Using Phone Books Manager

Enable Phone Book Manager Server	<input type="checkbox"/> Clients List
Share Phone Book to Clients	<input type="checkbox"/>
TTL (Expire time: mins) [ 1 - 60 ]	1
Register to Phone Book Manager	<input type="checkbox"/>
Gateway Name for Phone Book Manager	
Phone Book Manager Login Password	
Confirm Password	
Phone Book Manager IP/Domain	192.168.1.1
Phone Book Manager Server Listen Port [ 1 - 65535 ]	1690

- **Enable Phone Books Manager Server:** It allows other Gateway users to register the IP address and telephone number in this Phone books manager. It is recommended that the unit appointed as the Phone Book Manager use static IP.
- **Share Phone Book to Clients:** While this option is enabled and the gateway is performing as a Phone Books Manager, this gateway will append its Phone Book entries to the Manager for other clients to lookup.
- **TTL (Time to Live):** If a Gateway system that is controlled by the Phone Books Manager does not report back within the deadline set by TTL, the system will be excluded from the user's list. Each Gateway should report to the Phone Books Manager once every 30 seconds.
- **Register to Phone Books Manager:** To register to the Phone Books Manager.
- **Gateway Name for Phone Book Manager:** The alias registered with the Phone Books Manager.
- **Phone Books Manager Login Password:** Enter the registered password. If this system is serving as the Phone Books Manager, the set password is also the password used for registering other Gateway systems.
- **Phone Books Manager IP/Domain:** Enter the IP address for the Phone Books Manager. It supports URL (Uniform Resource Locator).
- **Phone Books Manager Server Listen Port:** The protocol communication port for transmitting signals between the Phone Books Manager and other Gateway systems. Please confirm whether the setting is the same as that of the **Phone Books Manager**.

## Network Settings (LAN)

LAN interface mode	
<input checked="" type="radio"/> Router <input type="radio"/> Bridge	
Network Settings (LAN)	
LAN IP / LAN default Gateway	<input type="text" value="192.168.8.254"/>
Subnet mask	<input type="text" value="255.255.255.0"/>
DHCP Server	
Enable DHCP Server	<input checked="" type="checkbox"/>
IP Pool Starting Address	<input type="text" value="192.168.8.1"/>
IP Pool Ending Address	<input type="text" value="192.168.8.250"/>
Lease Time [1 - 9999 hours]	<input type="text" value="1"/>
Domain Name Server Assignment	<input checked="" type="radio"/> Auto <input type="radio"/> Manual
Domain Name Server (Primary) IP	<input type="text"/>
Domain Name Server (Secondary) IP	<input type="text"/>
Port of Web Access from WAN [0=disable, 1 - 65535]	<input type="text" value="80"/>
Enable Web UI	<input checked="" type="checkbox"/>
Enable Telnet Service	<input checked="" type="checkbox"/>

### LAN interface mode✖

LAN interface mode
<input checked="" type="radio"/> Router <input type="radio"/> Bridge

- Router: The system serves as a router with NAT.
- Bridge: The system serves as a bridge between WAN port and LAN port without NAT. (LAN default gateway will still be accessible for configuration).

### LAN IP/Subnet mask

Network Settings (LAN)	
LAN IP / LAN default Gateway	<input type="text" value="192.168.8.254"/>
Subnet mask	<input type="text" value="255.255.255.0"/>

Gateway LAN Port IP address and the subnet mask value. Please note that Gateway is built with NAT: Gateway LAN Port IP address cannot be in the same section as the NAT LAN Port IP address, or else it is unable to make or receive calls. For example, if the NAT LAN Port IP address is 192.168.8.1, then Gateway LAN Port cannot be ranged between 192.168.8.1 ~ 192.168.8.254. If so, please change the LAN

port IP address, (e.g. setting the IP address to 192.168.99.254.)

## DHCP Settings

DHCP Server	
Enable DHCP Server	<input checked="" type="checkbox"/>
IP Pool Starting Address	<input type="text" value="192.168.8.1"/>
IP Pool Ending Address	<input type="text" value="192.168.8.250"/>
Lease Time [1 - 9999 hours]	<input type="text" value="1"/>
Domain Name Server Assignment	<input checked="" type="radio"/> Auto <input type="radio"/> Manual
Domain Name Server (Primary) IP	<input type="text"/>
Domain Name Server (Secondary) IP	<input type="text"/>

- Enable DHCP Server: Enable or Disable DHCP server service of gateway.
- IP Pool Starting Address: The first IP address to be assigned to DHCP clients.
- IP Pool ending Address: The last IP address to be assigned to DHCP clients.
- Lease Time: The valid period of an assigned IP address.
- Domain Name Server Assignment: The DNS information to be assigned to DHCP clients.  
Auto : Assigns the same DNS information of WAN port to the DHCP clients.  
Manual : Manually assigns the DNS information for DHCP clients.

Port of Web Access from WAN [0=disable, 1 - 65535]	<input type="text" value="80"/>
Enable Web UI	<input checked="" type="checkbox"/>
Enable Telnet Service	<input checked="" type="checkbox"/>

- Port of Web Access from WAN: Http port for WAN. To make this setting, the LAN Port must be used. **WAN Port cannot make this setting.** Always use port 80 when connecting to LAN port. 0 is to disable http port for WAN.
- Enable Web UI: It disables any access from WAN and LAN if ticked.
- Enable Telnet Service: It allows user to make settings from Telnet.



## QoS Settings

### WAN QoS

WAN QoS		
<input type="checkbox"/> QoS	Downstream Bandwidth	Full
	Upstream Bandwidth	Full
ToS / DiffServ Settings		
	ToS IP Precedence	3 (Flash)
Precedence	<input checked="" type="radio"/> Voice Data Precedence	5 (CRITIC / ECP)
DiffServ (DSCP)	<input type="radio"/> Signaling Value	26 (Assured Forwarding Class 3 - Low Drop Precedence, AF31)
	<input type="radio"/> Voice Data Value	46 (Expedited Forwarding, EF)

- QoS (Quality of Service): Sets an external bandwidth to ensure sound quality during transmission (When this function is enabled, the voice packet has the highest priority to ensure telecommunication quality while less bandwidth is assigned for data transmission). Some models of the gateway without this function can adjust the bandwidth automatically.
- ToS/DiffServ (Type of Service/DSCP): The voice packet has the highest priority to ensure telecommunication quality; the larger the value you set, the higher priority you will get.

### LAN QoS※

LAN QoS				
Enable LAN QoS	<input type="checkbox"/>			
Port	Priority	Flow Control	Incoming Rate Limit	Outgoing Rate Limit
LAN Port 1	Low	<input type="checkbox"/>	Full	Full
LAN Port 2	Low	<input type="checkbox"/>	Full	Full
LAN Port 3	Low	<input type="checkbox"/>	Full	Full
LAN Port 4	Low	<input type="checkbox"/>	Full	Full

- Priority: Set the priority of physic LAN port.
- Flow Control: Enable or Disable Flow control.
- Incoming Rate Limit: Set the incoming rate limit of a specific LAN port.
- Outgoing Rate Limit: Set the outgoing rate limit of a specific LAN port.

## NAT/DDNS

### NAT Traversal

NAT Traversal		
NAT Public IP <input type="checkbox"/>	NAT IP/Domain	<input type="text"/>
Enable STUN Client <input type="checkbox"/>	STUN Server IP / Domain	<input type="text"/>
	STUN Server Port[1 ~ 65535]	<input type="text" value="3478"/>
Enable UPnP Control Point <input type="checkbox"/>		

**If a Gateway is set up under an IP sharing setting, you can select either the NAT or STUN protocol.**

- NAT Public IP: The IP address used by the gateway should be a virtual address. Further more, users must set the Virtual Server Mapping in the NAT Server (A virtual server is defined as a Service Port, and all requests to this port will be redirected to this specified the server IP address).

The default port is listed below:

Listen Port (UDP): 5060

RTP Starting Port (UDP): 9000~9015 (Listen Port used for telephone communication).

Http Port (TCP): 80

- NAT IP/Domain: Enter the NAT Server IP address (Real External IP address of NAT Server) then fill in the URL (Uniform Resource Locator). If using DDNS, please refer to the next setting item
- Enable STUN Client: Using STUN protocol prevents problems with setting the IP sharing function, but some NAT do not support this protocol.
- STUN Server IP/Domain and Port: Enter the STUN server IP address and Listen Port number. You can set 2 STUN server spread by semicolon.
- Enable UPnP Control Point: To enable the gateway's IP traffic to pass through a NAT server. This function only works when the NAT server supports UPnP and has it enabled.

## DDNS

<input type="checkbox"/> Register to DDNS	
<hr/>	
<input type="radio"/> <b>DynDNS DDNS Server</b>	<input type="button" value="Default"/>
Server Address	<input type="text" value="members.dyndns.org"/>
Hostname	<input type="text" value="dyndns.org"/>
Login ID	<input type="text"/>
Password	<input type="password" value="....."/>
Confirm Password	<input type="password" value="....."/>
Behind NAT	<input type="checkbox"/> Yes
Custom	<input type="checkbox"/>
<hr/>	
<input type="radio"/> <b>TZO DDNS Server</b>	<input type="button" value="Default"/>
Server Address	<input type="text" value="rh.tzo.com"/>
Hostname	<input type="text" value="tzo.com"/>
E-Mail Address	<input type="text"/>
Key	<input type="text"/>
Behind NAT	<input type="checkbox"/> Yes
<hr/>	
<input type="radio"/> <b>3322 DDNS Server</b>	<input type="button" value="Default"/>
Server Address	<input type="text" value="members.3322.org"/>
Hostname	<input type="text" value="3322.org"/>
Login ID	<input type="text"/>
Password	<input type="password" value="....."/>
Confirm Password	<input type="password" value="....."/>
Behind NAT	<input type="checkbox"/> Yes
<hr/>	
<input type="radio"/> <b>PeanutHull DDNS Server</b>	<input type="button" value="Default"/>
Server Address	<input type="text" value="hph008.oray.net"/>
Hostname	<input type="text" value="vicp.net"/>
Login ID	<input type="text"/>
Password	<input type="password" value="....."/>
Confirm Password	<input type="password" value="....."/>
<hr/>	
<input checked="" type="radio"/> <b>DDNS Server</b>	<input type="button" value="Default"/>
Server Address	<input type="text"/>
Hostname	<input type="text"/>
Login ID	<input type="text"/>
Password	<input type="password" value="....."/>
Confirm Password	<input type="password" value="....."/>
Behind NAT	<input type="checkbox"/> Yes

These settings are only necessary when the gateway is set up under a NAT that uses a dynamic IP address and do not support DDNS.

Choose a DDNS Server: The current system allows users to choose either DynDNS · TZO · 3322.org · PeanutHull or a private server. Please apply for a user account before choosing a service provider.

- Server address: Sets up the IP address or URL (Uniform Resource Locator) of the DDNS Server.
- Hostname: The URL of the system (or NAT) – apply from a domain name registration providers.
- Login ID and Password: The ID and password are used to log into the DDNS server.
- Behind NAT: Select only when the system is set up under NAT.

**Note: If the Gateway is set up under NAT, then enter the hostname into the NAT IP/Domain that is the same with Hostname of DDNS.**

**Example:**

NAT

NAT Traversal	
NAT Public IP <input checked="" type="checkbox"/>	NAT IP/Domain <input type="text" value="hostname.ddnsserv.com"/>

DDNS

Register to DDNS

DynDNS DDNS Server Default

Hostname

## Telephony Settings

### Prefix Number Rules

Prefix Number Rules	
Trunk Dial Out Verify	<input type="text"/>
Trunk Dial Out Replace	<input type="text"/>
Trunk Dial Out Deny	<input type="text"/>

- Trunk Dial Out Verify/ Trunk Dial Out Replace: VoIP gateway will check (verify) the dial out prefix from dial out numbers and change (replace) the prefix to transit out through FXO port.

**For example:**

If you transit out with 01907123456, the system will trans to 190601 907123456. If you transit out with 008621123456 the system will replace it with 190200 8621123456.

- Trunk Dial Out Deny: The system will deny the call with the leading number filled in this column.

FXO Caller ID Detection	<input checked="" type="checkbox"/>
Detection Level	0 ▾
FSK Caller ID Type	<input checked="" type="radio"/> Bellcore <input type="radio"/> ETSI
Anonymous Caller ID (CLIR)	<input type="checkbox"/>
Anonymous Transit in W/O Caller ID	<input type="checkbox"/>
Trunk Incoming Prompt Voice	<input checked="" type="radio"/> Default Greeting <input type="radio"/> Recorded voice file <input type="radio"/> Dial Tone
Upload Greeting	<input type="text"/> <input type="button" value="Browse..."/> <input type="button" value="Upload"/> <input type="button" value="Backup"/>
FXO Hunting VoIP call in option	Caller Indicate Dial-Out ▾
FXO Hunting Default Dial-Out	<input type="text"/>
FXO Line VoIP call in option	Caller Indicate Dial-Out ▾

- FXO Caller ID Detection: To detect the Caller ID delivered from PSTN to the FXO port. While enabled, the Caller ID detected on the FXO port will be send to the SIP Proxy Server on dialing out calls.
- Detection Level: The gain volume occurs on Caller ID detection.

**Note: You have to enable “Wait for Caller ID before FXO / Trunk pick up” to ensure Caller ID is detected correctly.**

- FSK Caller ID Type: Select FSK type. In most cases, Bellcore is preferred in North America and ETSI in Europe.
- Anonymous Caller ID (CLIR): When enabled, the caller’s phone set will not display your number.

**Note: If you register the gateway to a Proxy, you may be unable to make a call. This is due to the fact that the gateway doesn’t send the number for authorization.**

- Anonymous Transit in W/O Caller ID: FXO won’t detect caller ID, and the gateway will dial out with anonymous caller identification. If the call needs caller ID to be identified for Proxy, Proxy will reject this call without caller id.
- Trunk Incoming Prompt Voice: Select the greeting (must use the IVR 132 function to record a voice file) when FXO receives an inbound call.
- Upload Greeting: It is able to upload the recorded voice file. The format must be G.723.
- FXO Hunting VoIP call in option: To set FXO dial-out mode by using the default setting or waiting caller to dial out when the VoIP call calls FXO hunting number.
- FXO Hunting Default Dial-Out: To set FXO default dial-out number.
- FXO Line VoIP call in options: To set FXO dial-out mode when the VoIP call indicates the FXO extension number.

Line	Enable	Type	Hot Line	Hot Line No.	Warm Line (Hot Line Delay) [0 - 60 s]	Dial-Out Prefix	FXO Line Default Dial-Out	Enable FAX
1	<input checked="" type="checkbox"/>	FXO	<input type="checkbox"/>	<input type="text"/>	0	<input type="text"/>	<input type="text"/>	<input checked="" type="checkbox"/>
2	<input checked="" type="checkbox"/>	FXO	<input type="checkbox"/>	<input type="text"/>	0	<input type="text"/>	<input type="text"/>	<input checked="" type="checkbox"/>

- Enable: Enable a line; if some lines are not used, disable them (Pause Function) to avoid unnecessary waiting when an incoming call is diverting to this line.

**Hotline Functions**

- FXO port: When receiving a call from an outside line, the gateway will divert the call to the assigned hotline number.
- Hot Line No.: Enter the hot line number for an automatic dialing function.
- Warm Line: When the warm line function is in use, user can dial a number. Otherwise the system will divert incoming calls from an outside line to the Hot Line Number after a set wait time.
- Dial-out Prefix: It is the number dialed automatically by the system when the FXO interface diverts a call to the PSTN by VoIP.
- FXO Line Default Dial-Out: To set the dial-out number when this FXO line is indicated.

**Example:**

If PBX extension needs to dial "0" to make a PSTN call, and the FXO are connected to PBX extension. In this case, the Dial-out prefix should be set to "0". If the PBX requires some delay time before capturing a line, then the trunk prefix should be set as "0," so that after dialing a 0, it will pause for 1 second before dialing the destination number. Each comma represents a 1 second delay. If more delay time is required, simply add more commas. Please note that if a Dial-out prefix is set, the line won't be able to dial to any PBX extension line (FXS interface does not have a trunk prefix function). Please refer to Section 6 if required to dial to a PBX extension line and PSTN concurrently.

- Enable FAX: Enable this line to detect if there is a FAX tone to transfer the Codec.

Trunk Hunting Order	First Idle <input type="button" value="v"/>
Enable FXO / Trunk Extension Number	<input checked="" type="checkbox"/>
Pick up Line by Dialing Extension Number	<input checked="" type="checkbox"/>
Wait for Caller ID before FXO / Trunk pick up	<input checked="" type="checkbox"/>
Transit in Busy Tone Limit [0 - 60 s]	<input type="text" value="3"/>
Ring (Early Media) Time Limit [10 - 600 s]	<input type="text" value="90"/>
Enable End of Digit Tone	<input type="checkbox"/>
VoIP Call Out Notification	<input type="checkbox"/>
Enable Built-in Call Hold Music	<input checked="" type="checkbox"/>
Force Calling Thru PSTN Code	<input type="text"/>
Trunk Early Media Option	One Way Voice <input type="button" value="v"/>
Early Media Treatment	<input checked="" type="checkbox"/>
Compare SIP 'To' Header for Transit Out	<input type="checkbox"/>
Max. External Call	<input type="text" value="999"/>

- Trunk Hunting Order: To set FXO dial-out mode when there is an incoming call dialed FXO representative number.  
 First Idle: The gateway will assign each unassigned call from first FXO line.  
 Sequential: The gateway will automatically assign the first unassigned call to the first FXO line. The second FXO line will dial the second unassigned call out. Each line will be used.
- Enable FXO/Trunk Extension Number: Select this function only when FXO receives 2 or more different PBX or PSTN, or under special circumstances. Users are free to call out from



a desired channel, if assigned. If you register to a Proxy it MUST be checked.

**Description:**

If the remote party wants to assign L4 (FXO) to make a call, he/she can dial 704 22520199.

If this item isn't checked, the gateway will select a line automatically to call out from. For example, dial 22520199 without adding the extension number of the FXO port.

- Pick up Line by Dialing Extension Number: Allows user to dial just the FXO extension – 703 - to use when the PSTN line is connected on the FXO port. If you are registered to a Proxy, it MUST be checked.
- Wait for Caller ID before FXO / Trunk pick up: To detect caller ID from FXO port.
- Transit in Busy Tone Limit: The duration gateway plays a busy tone before FXO hook-on. To notify the caller from PSTN that this call is finished.
- Ring Time Limit(10 - 600secs) : The timeout to cancel a call when no one answers.
- Enable End of Digit Tone : The gateway will play a “Beep-Beep” tone to notify the call is in progress.
- VoIP Calling Notification: The gateway will play a tone to notify the call is through VoIP.
- Force Calling Thru PSTN code: Dial the code to get a PSTN line for dial out. For example: If you would like dial “23456789” through PSTN and Force Calling Thru PSTN code is \*33, just dial “\*33 23456789”
- Early Media Treatment: If it is disabled, the system will send RTP immediately when the connection with Proxy is set up. The default is enabled. If communicating with other Gateway has problem, please disable this function.
- Compare SIP 'To' Header for Transit Out: When FXO is callee and the number of Request line and “To” is different, the system will use the number of “To” to dial out. Please consult your Proxy Server Provider or ITSP about the format of invite packet from Proxy.

# SIP

All Call through OutBound Proxy	<input type="checkbox"/>
OutBound Proxy IP / Domain	<input type="text"/>
OutBound Proxy Port [1 - 65535]	<input type="text" value="5060"/>

- All Call through OutBound Proxy : An outbound proxy server handles SIP call signaling as a standard SIP proxy server would. Furthermore, it receives and transmits phone conversation traffic (media) in between two talking gateways. This option tells the gateway to send and receive all SIP packets to the destined outbound proxy server rather than the remote gateway. This helps VoIP calls to pass through any NAT protected network without additional settings or techniques. Please make sure your VoIP service provider supports outbound proxy services before enable it.

Session Expiration [0=disable, 10 - 1800]	<input type="text" value="0"/>
Session Refresh Request	<input checked="" type="radio"/> UPDATE <input type="radio"/> re-INVITE
Session Refresher	<input checked="" type="radio"/> UAS <input type="radio"/> UAC

- Session Expiration: It is to avoid the billing of abnormal dropping the call because of Internet. The default is disabled.
- Session Refresh Request: to send the packet of UPDATE or re-INVITE to
- Session Refresher: It is the gateway's role in Session Timer. UAS is an originator, and UAC is a replier.

Enable P-Assert	<input type="checkbox"/>
Privacy Type	<input type="text" value="id"/>

- Enable P-Assert: It is for caller id protect.
- Privacy Type: Privacy requested for Third-Party Asserted.

SIP Message Resend Timer Base [s]	<input type="text" value="0.5"/>
Max. Response Time for Invite [1 - 20]	<input type="text" value="8"/>
Invite URL need 'user=phone'	<input checked="" type="checkbox"/>
Reliability of Provisional Responses	<input type="checkbox"/>
Compact Form	<input checked="" type="checkbox"/>

- SIP Message Resend Timer Base: SIP packet will resend if response didn't arrive in the base time set in this column. It will send again at "base time" \* 2, and send again at "base time" \* 2 \* 2. The max of resend time is 4 sec. Resend will stop/restart when total resend 20sec has reached.
- Max. Response Time for Invite: If the destination does not reply in the set time, this call is failed.
- Invite URL need 'user=phone': There is 'user=phone' in invite packet.
- Reliability of Provisional Responses: Provide information on the progress of the request processing if ticked.
- Compact Form: It decreases the size of SIP header if ticked.



## E.164

International Call Prefix Digit	<input type="text"/>
Country Code	(Other) <input type="text"/> <input type="button" value="v"/>
Long Distance Call Prefix Digit	<input type="text"/>
Area Code	<input type="text"/>
E.164 Numbering	To Invite Proxy <input type="checkbox"/>
	Transform to Transit Out <input type="checkbox"/>
ENUM Header Exception	<input type="text" value="070"/>

- International Call Prefix Digit: Enter the International call prefix.
- Country Code: Users please select the desired country code.
- Long Distance Call prefix Digit: The long-distance prefix digit for making a long-distance call.
- Area Code: Please enter the area code.
- E.164 Numbering: To invite Proxy to follow the E.164 rule. It depends on the Proxy. **If you fail to make a call, please contact your ITSP.**

<input type="checkbox"/> Enable Support of SIP Proxy Server / Soft Switch	
<input checked="" type="checkbox"/> <b>Enable SIP Proxy 1</b>	
Proxy Server IP / Domain	<input type="text" value="192.168.1.1"/>
Proxy Server Port [1 - 65535]	<input type="text" value="5060"/>
Proxy Server Realm	<input type="text"/>
TTL (Registration interval) [10 - 7200 s]	<input type="text" value="600"/>
SIP Domain	<input type="text"/>
Use Domain to Register	<input type="checkbox"/>
<input type="checkbox"/> <b>Enable SIP Proxy 2</b>	
Proxy Server IP / Domain	<input type="text" value="192.168.1.1"/>
Proxy Server Port [1 - 65535]	<input type="text" value="5060"/>
Proxy Server Realm	<input type="text"/>
TTL (Registration interval) [10 - 7200 s]	<input type="text" value="600"/>
SIP Domain	<input type="text"/>
Use Domain to Register	<input type="checkbox"/>
Bind Proxy Interval for NAT [0 - 180 s]	<input type="text" value="0"/>
Initial Unregister	<input type="checkbox"/>
Enable Message Waiting Indication (MWI)	<input type="checkbox"/>
Proxy-Require	<input type="text"/>

- Enable Support of SIP Proxy Server / Soft Switch: Enable the functions to inter-work with Proxy Server / Soft Switch. When SIP Proxy 1 and 2 are enabled, the system will register to SIP Proxy 2 after all lines are failed to register to SIP Proxy 1. **SIP Proxy 2 is a backup system.**
- Proxy Server IP/Domain: Enter the Proxy Server IP address or URL (Uniform Resource Locator). You can set 3 redundant Proxy spread by semicolon.  
EX: 61.123.231.1;12.34.56.78;proxy.sip.sip
- Proxy Server Port: Enter the Proxy Server **listen** port number. (The factory default value is 5060)
- Proxy Server Realm: Enter the correct registered Proxy Server Realm name to avoid registration failure. **If you fail to make a call, please contact your ITSP.**
- TTL: Enter the desired time interval at which the gateway will report to you Proxy Server.
- SIP Domain/Use Domain to Register: Enter the correct SIP domain to avoid registration failure (it is not necessary to set with some Proxy Servers). If you enable "Uses Domain to Register" the gateway will register to Proxy with the domain name you filed. Else, the gateway will register to a Proxy with the IP it resolves. **If you fail to make a call, please contact your ITSP.**
- Bind Proxy Interval for NAT: This function is able to keep the binding is existed when the gateway is behind NAT and SIP Proxy is not able to keep the binding.
- Initial Unregister: After rebooting, it is unregistered first and then do the general registry process.

- Enable Message Waiting Indication: The system will play a tone to remind users that there are messages in SIP Server.
- Proxy-Require: Some SIP Sever need SIP UA to add this header to it's sip message.

### FXO Representative number registers to Proxy:

Line	Type	Number	Register	Invite with ID / Account	User ID / Account	Password	Confirm Password
FXO Representative Number		0144	<input checked="" type="checkbox"/>		neko12	.....	.....

Assuming that your registered ID and password are individual, the settings should be as above.

- FXO Representative Number: Register all FXO ports as a hunting group. All the grouped FXO ports will be hunted automatically. It is available when FXO registers to Proxy.
- Register: Register to Proxy if ticked.
- Invite with ID / Account: DVG-6008S can be invited to a VoIP trunk gateway w/o register to a Proxy. Please contact your ITSP

**NOTE: Please ensure that if Proxy Server allows one account for many ports using before using representative number to register.**

### Each line registers to Proxy independently:

Line	Type	Number	Register	Invite with ID / Account	User ID / Account	Password	Confirm Password
1	FXO	701 <input type="button" value="Auto"/>	<input checked="" type="checkbox"/>	<input checked="" type="checkbox"/>	neko1	.....	.....
2	FXO	702	<input checked="" type="checkbox"/>	<input checked="" type="checkbox"/>	neko2	.....	.....
3	FXO	703	<input checked="" type="checkbox"/>	<input checked="" type="checkbox"/>	neko3	.....	.....
4	FXO	704	<input checked="" type="checkbox"/>	<input checked="" type="checkbox"/>	neko4	.....	.....

- Invite with ID / Account: The gateway can be invited to a VoIP trunk gateway w/o register to a Proxy. Please contact your ITSP

As there are various Proxy Server providers, our company has designed the gateway to be compatible with them, and according to RFC standards. If any registration problem occurs, please consult your Proxy Server provider.

**NOTE: When you register with a Proxy Server, dialing principles may vary with different Proxy Servers, especially when dialing through a remote end FXO port. Please consult your Proxy Server Provider.**

## Calling Features

Line	Type	Do Not Disturb	Unconditional Forward	Busy Forward	No Answer Forward	Call Hold	Call Transfer	Call Waiting	Three-Way Calling / Service ID
FXO Representative Number			<input type="checkbox"/>	<input type="checkbox"/>	(N/A)	(N/A)	(N/A)	(N/A)	(N/A)
1	FXO	<input type="checkbox"/>	<input type="checkbox"/>	<input type="checkbox"/>	(N/A)	(N/A)	(N/A)	(N/A)	(N/A)
2	FXO	<input type="checkbox"/>	<input type="checkbox"/>	<input type="checkbox"/>	(N/A)	(N/A)	(N/A)	(N/A)	(N/A)
3	FXO	<input type="checkbox"/>	<input type="checkbox"/>	<input type="checkbox"/>	(N/A)	(N/A)	(N/A)	(N/A)	(N/A)
4	FXO	<input type="checkbox"/>	<input type="checkbox"/>	<input type="checkbox"/>	(N/A)	(N/A)	(N/A)	(N/A)	(N/A)

- Unconditional Forward: All incoming calls will be forwarded to the “Forwarding Number” automatically.
- Busy Forward: Forward the incoming call to “Forwarding Number” when the port is busy.
- No Answer Forward: Forward the incoming call to “Forwarding Number” after ring timeout expires without answer.

## Advanced Options

Administrator's Name	<input type="text"/>
Administrator's Password	<input type="password"/>
Confirm Password	<input type="password"/>
Web UI Login ID	<input type="text"/>
Web UI / IVR Password	<input type="password"/>
Confirm Password	<input type="password"/>
Web UI auto logout [30 - 300 s]	<input type="text" value="60"/>

- There are two levels to enter Web. Administrator is able to change all settings. Web UI only changes some settings.

**NOTE: Enter new Login ID and password for two levels.**

- Web UI auto log out: When logging in a web page, if a user does not act within the effective time range, the user will be disconnected from the web page to allow others to login.

Dial Wait Timeout [1 - 60 s]	<input type="text" value="10"/>
Inter Digits Timeout [1 - 60 s]	<input type="text" value="4"/>
Minimum DTMF ON Length [40 - 500 ms]	<input type="text" value="80"/>
Minimum DTMF OFF Length [40 - 500 ms]	<input type="text" value="80"/>
DTMF Detection Sensitivity	(less) <input type="radio"/> 1 <input type="radio"/> 2 <input checked="" type="radio"/> 3 <input type="radio"/> 4 <input type="radio"/> 5 (more)

- Dial Wait Timeout: Use it to set the waiting time for the user's first key pressing when dialing a number. The user will hear a busy tone if he/she does not press the first key within the set time frame.
- Inter Digits Timeout: Set the waiting time between each key pressing. The inputted numbers will be dialed after the timeout.
- Minimum DTMF ON Length (Dial on)/ Minimum DTMF OFF Length (Dial off - between tones): Used to set dial tone when a call is being diverted to another extension.
- DTMF Detection Sensitivity: Used to adjust the sensitivity of the telephone keys.

FXO Dial Type	<input type="text" value="DTMF"/>
Pulse Dial Mark/Space Ratio	<input type="text" value="US (61:39 %)"/>
FXO Impedance	<input type="text" value="Taiwan 600 Ohm"/>

- FXO Dial Type: Choose dialing type of FXO. There are DTMF and Pulse. ✘
- Pulse Dial Mark/Space Ratio: Duration and break of pulse dial ration. ✘
- FXO Impedance: Choose correct impedance in your country/area. ✘

Enable Out-of-Band DTMF <input type="checkbox"/>	<input type="checkbox"/> Enable Hook Flash Event <input checked="" type="radio"/> RFC 2833 Payload Type <input type="text" value="101"/> <input type="radio"/> SIP Info
Use Second CPT after SIP registered	<input type="checkbox"/>

- Enable Out-of-Band DTMF: To send DTMF keys (0~9, \*, #,) follow the RFC2833 rules or via SIP Info.
- Enable Hook Flash Event: The gateway will deliver the flash signal to remote party via RFC2833 or SIP Info.
- Payload Type : Payload type of RFC2833.
- Uses Second CPT for VoIP Call: This function is usually applied when the user selects VoIP as the primary path for outgoing calls and PSTN as the backup. By enabling this function, the gateway will generate a different set of tones to inform the user that VoIP is in service. Should VoIP fails and fallback to PSTN, the user will hear PSTN tones instead of the second set CPT. (for CPT related settings, please refer to Trunk Management -> CPT Settings)

## Line Settings

Line	Extension Number	Type	Listening Volume	Speaking Volume	Tone Volume	Flash Time	Enable Polarity Reversal	PSTN Answer Detection	PSTN Ring OFF Length [1000 - 20000 ms]
1	701	FXO	<input type="text" value="0"/>	<input type="text" value="0"/>	<input type="text" value="5"/>	<input type="text" value="0.6"/>	<input type="checkbox"/>	<input type="text" value="Disable"/>	<input type="text" value="2000"/>
2	702	FXO	<input type="text" value="0"/>	<input type="text" value="0"/>	<input type="text" value="5"/>	<input type="text" value="0.6"/>	<input type="checkbox"/>	<input type="text" value="Disable"/>	<input type="text" value="2000"/>

- Listening Volume: Adjusts the hearing volume.
- Speaking Volume: Adjusts the speaking volume.
- Tone Volume: Adds a new option to make tone volume adjustable. This setting will be applied to all tones generated by the gateway including Dial Tone, Busy Tone, and so on.
- Flash Time: Used to set the time frame that FXO generates a FLASH signal.
- Enable Polarity Reversal: This option forces the gateway to detect the reversal of polarity on FXO port as the primary signal to drop a call. Some telephone switches or PBX reverse the line polarity to inform the remote end to drop an ongoing call. Please consult with the telephone service provider for availability of this feature.
- PSTN Answer Detection: This is only used with ITSP.
- PSTN Ring OFF Length: FXO/PSTN make out if the call from PSTN hangs up before FXS answer the call. ※

## Codec

Codec Settings					
Preferred Codec Type	G.723.1 6.3kbps				
Jitter Buffer [60 - 1200 ms]	120				
Silence Detection / Suppression	<input type="checkbox"/>				
Echo Cancellation	<input checked="" type="checkbox"/>				
Codec	<input checked="" type="checkbox"/> G.711 u-law	<input checked="" type="checkbox"/> G.723.1	<input checked="" type="checkbox"/> G.726	<input checked="" type="checkbox"/> G.729A	<input checked="" type="checkbox"/> G.711 a-law
Packet Interval (ms)	20	30	20	20	20
Approximate Bandwidth Required (kbps)	85.6	20.8	53.6	29.6	85.6

- Preferred Codec Type: Since different voice codec have different compression ratios, so the sound quality and occupied bandwidths are also different. It is recommended to use the default provided (G.723.1) because it occupies less bandwidth and will provide better sound quality.
- Jitter Buffer: Adjusts the jitter to receive a packet. If the jitter range is too wide, it will delay voice transmission.
- Silence Suppression: If one side of a connection is not speaking, the system will stop sending voice data (package) to decrease bandwidth usage.
- Echo Canceling: Prevents poor telecommunication quality caused by echo interference.
- Codec: Choose the codec that you needs.
- Packet Time: Defines how long the gateway sends a RTP packet-voice packet- to the other side. The smaller the value, the more bandwidth usage. The larger the value, the more voice delay.
- Approximate Bandwidth Require: The bandwidth required varies with Codec format and packet time.

## Fax Settings

FAX Settings	
T.38 <input checked="" type="radio"/>	<input checked="" type="radio"/> UDP <input type="radio"/> TCP <input checked="" type="checkbox"/> Enable High Quality
T.30 <input type="radio"/>	FAX Codec: G.726 32kbps FAX Jitter Buffer [60 - 1200 ms]: 360
FAX Tone Detection Sensitivity	(less) <input type="radio"/> 1 <input checked="" type="radio"/> 2 <input type="radio"/> 3 <input type="radio"/> 4 <input type="radio"/> 5 (more)

- T.38: The T.38 protocol is used for better and faster facsimile transmission. When this function is enabled, the following fax and voice parameter settings will be disabled, so it is recommended to enable this function to gain better fax quality. When this function is enabled, please select UDP, TCP, or AUTO. If selecting TCP and some routers cannot use the Fax function, please select UDP instead.
- Enable High Quality: The system sends the same FAX frame twice to get a high quality of the FAX. It requires more bandwidth.
- Enable Secure T.38: This allows gateways to send faxes on both sides.

- T.30: The system uses T.30 as the protocol for fax transmission. The parameter settings are the same as for voice transmission. However, enabling the fax function will consume more network resources and will affect transmission quality.
- FAX Detect sensitivity : Used to adjust the sensitivity of detection as to whether a phone call is a FAX or not.

Drop Inactive Call	
Silence Detection Threshold [0 - 60 db]	<input type="text" value="0"/> (0 : Disable)
Drop Silent Call Timeout [30 - 3600 s]	<input type="text" value="120"/>

This is used as a standard to determine whether or not to hang up the phone. The system will hang up the phone automatically to avoid keeping the line engaged if the detected volume is below the Silence Detection Threshold and the time exceeds the Drop Silent Call Timeout.

- Silence Detection Threshold: Set the volume as a standard.
- Drop Silent Call Timeout: Set the time to hang up the phone.



## Digit Map

There are 50 sets of leading digit entries to choose voice routing interface – Auto select, PSTN or VoIP.

Default Call Route Auto (VoIP first) ▼

- Default Call Route: The default call route can be Auto, VoIP, PSTN and Deny.  
 Auto (VoIP first): The call route is VoIP first, and the next is PSTN.  
 VoIP: The call route is VoIP only.  
 PSTN: The call route is FXO only.  
 Deny: The call will be deny if the dial-out number is not in the table.

#	Enable	Leading Digits	Total Digit Count [0=disable, 1- 40]	Route
1	<input type="checkbox"/>	<input type="text"/>	<input type="text" value="10"/>	Auto (VoIP first) ▼
2	<input type="checkbox"/>	<input type="text"/>	<input type="text" value="10"/>	Auto (VoIP first) ▼
3	<input type="checkbox"/>	<input type="text"/>	<input type="text" value="10"/>	Auto (VoIP first) ▼

- Enable: Enable detection of this entry.
- Leading Digits: The leading digits for the gateway to scan while user is dialing.
- Total Digit Count: Total number of digits that the gateway should accept. 0 is that the gateway scans leading digits only and disregards total digit count.
- Route: The interface calls should go through if above conditions satisfied.

## Phone Book

This system can set up and store 100 phone numbers into a phone book and provides an IP address query when calling to other gateway(s). If no Phone books manager is set within a gateway group, then all Gateway systems have to set up phone data for each the gateway to communicate with each other.

#	Gateway Name	Gateway Number	IP / Domain Name	Port
<a href="#">1</a>				5060
<a href="#">2</a>				5060
<a href="#">3</a>				5060
<a href="#">4</a>				5060
<a href="#">5</a>				5060

- Gateway Name: Enter other gateways' code or an easy-to-remember name.
- Gateway Number: Enter the desired number of other Gateways.
- IP/Domain Name: Enter the IP address or URL (Uniform Resource Locator) of other gateways.
- Port: Enter other Gateways' listen port.

## Speed Dial

It can set up 100 numbers for speed dialing. Setting methods are as follows.

#	Speed Dial Code("?" = single digit ; "%" = wildcard)	Number To Dial
1	55	32568791
2	3??	5213??
3	00%	856%

Method 1- Single mapping: Fill a short code into the "Speed Dial Code" column, and enter the desired phone number into the "Number To Dial" column.

For example, pick up the handset and dial **55 #** and the system will dial 32568791.

Method 2- Multi mapping; Fill the prefix code into the "Speed Dial Code" column and the format to transfer into the "Number To Dial" column.

For example, pick up the handset and dial **301 #**, and the system will dial 521301.

**If the user dial 00 1657987456321, the system will DIAL 856 1657987456321**

## Caller Filter

This function is used to allow or deny SIP Invite from the Proxy list ONLY.

<input checked="" type="radio"/> Allow <input type="radio"/> Deny		
Enable	Filter IP address	Subnet mask
<input type="checkbox"/>	<input type="text"/>	<input type="text"/>
<input type="checkbox"/>	<input type="text"/>	<input type="text"/>
<input type="checkbox"/>	<input type="text"/>	<input type="text"/>

- Filter IP Address: Fill up with the start IP you would like to allow/deny.
- Subnet mask: Fill up with the subnet mask you would like to allow/deny.

## ACL for Management

You can use ACL to allow the user that is from some IP address to enter Web.

<input type="checkbox"/> Enable ACL for Management		
Filter IP address	Subnet mask	Web
<input type="text"/>	<input type="text"/>	<input type="checkbox"/>
<input type="text"/>	<input type="text"/>	<input type="checkbox"/>
<input type="text"/>	<input type="text"/>	<input type="checkbox"/>

- Enable ACL for Management: Enable ACL for Management if ticked.
- Filter IP Address: Fill up with the start IP you would like to allow.
- Subnet mask: Fill up with the subnet mask you would like to allow.
- Web: Enable management from Web if ticked.

## CDR Settings

The user can set up a CDR Server to record call details for every phone call. The present CDR provides the call detail recording in a text file and if needed, it can be imported to prepare for an analysis report.

<input type="checkbox"/> Send record to CDR Server	
CDR Server IP	<input type="text"/>
Port [1 - 65535]	<input type="text" value="8080"/>

- Send record to CDR Server: Enables the call detail recording function.
- CDR Server IP: Enter the IP address of the CDR server.
- Port: Enter the listen port of the CDR server.

## Language

The system provides English, Traditional Chinese, and Simplified Chinese to display text on Web pages. Meanwhile, it will change the language for IVR (Interactive Voice Response).

Web UI / IVR Language	English
-----------------------	---------

## Transit Call Control

If you wish to restrict a general user (one who is not required to enter the PIN code) to local calls only and prohibit him/her from making long-distance calls started with a prefix “0”, do the following steps:

1. Enable the Outbound Call Control function,
2. Set the PIN code for Outbound Level 5 to blank,
3. Set the Long-Distance Control Table to correspond with the Outbound Level 5 to prohibit making any call with the prefix “0” (as shown above).

**Note: Transit Call Control is effective when it cooperate with Long-Distance Control Table.**

Inbound Call Control	<input type="checkbox"/>
Outbound Call Control	<input type="checkbox"/>

- Inbound Call Control: To determine when users make a phone call from a PSTN to Gateway FXO whether or not they check the inbound PIN code while using a VoIP — only effective for incoming calls calling from a PSTN trunk.
- Outbound Call Control: To determine when users utilize Gateway FXO interface to divert to a PSTN whether or not they check the outbound PIN code — only effective for outgoing calls being diverted to a PSTN Trunk.

#	PIN Code	Enable	Privileges
1	<input type="text"/>	<input type="checkbox"/>	0
2	<input type="text"/>	<input type="checkbox"/>	0
3	<input type="text"/>	<input type="checkbox"/>	0

- PIN Code: Enter the PIN code (4-6 digits or leave blank. A blank indicates no PIN code is required at this level. Generally, the PIN at level 5 can remain blank to simplify the phone number.)
- Enable: Enables the PIN code at each level.
- Privileges: The level is divided into 0~5 (The levels are in descending order; 0 stands for the highest authority and 5 stands for the lowest.)

## Long-Distance Control Table

This table controls the level of authority of an outgoing call through FXO.

#	0	<u>1</u>	<u>2</u>	<u>3</u>	<u>4</u>	<u>5</u>
1	0204					
2						
3						

If Level 0 (the highest level) is set to prohibit dialing any number started with prefix 0204, then any level below 0 (including Levels 1 to 5) is also prohibited.

If Level 1 is set to prohibit dialing any number with prefix 0, then any level below 1 (including Levels 2 to 5) is also prohibited. Since Level 0 is not restricted to any prefix, therefore at level 0 users can dial a number with the prefix 0.

**Note: Downward Restriction** —If the users at a higher level cannot dial a number with a certain prefix, then users at lower level also cannot dial a number with the same prefix.

## Long Distance Exception Table

This table handles any exceptions to the long-distance call table.

According to the Long Distance Control Table, users at Level 0 are prohibited to dial a number with the prefix 0204. But, if the number 020488988 is set in the Exception Table as above, then users could then dial this number.

#	0	<u>1</u>	<u>2</u>	<u>3</u>	<u>4</u>	<u>5</u>
1	020488988					
2						
3						

**Note: Upward Opening** —If the users at a lower level can dial a number with a certain prefix, then the users at higher levels can also dial a number with the same prefix.

## CPT/Cadence Settings

CPT/Cadence setting parameters serve as the basis of an FXO interface to determine whether or not a PSTN-call receiving party has hung up the phone. If the following parameters differ from the parameters of the actual assigned lines, it could cause the FXO to continue to engage a line.

### Busy Tone Cadence Measurement

Enable <a href="#">Busy Tone Cadence Measurement</a>		T_ON_1	T_OFF_1	T_ON_2	T_OFF_2	Auto Learning
BTC # 1		0	0	0	0	Yes
BTC # 2		0	0	0	0	Yes
BTC # 3		0	0	0	0	Yes
BTC # 4		0	0	0	0	Yes
BTC # 5		0	0	0	0	Yes

BTC Detection Sensitivity (less)  1  2  3  4  5 (more)

- Busy Tone Cadence Measurement: Provide a best solution of FXO integrated with PSTN or PBX. FXO will learn the busy tone automatically.
- BTC Detection Sensitivity: The more sensitivity, the more quickly the system will cut off the call. If the system often cut off an un-finished call, select less sensitivity.

### CPT parameters Table

The CPT has 3 sets of parameter tables. Please adjust the CPT based on local PSTN or PBX.

# 1 Enable	Setting 1		Default			
Tone Type	Low Frequency	High Frequency	T_ON_1	T_OFF_1	T_ON_2	T_OFF_2
Dial Tone	350	440	3000	0	0	0
Congestion Tone	480	620	250	250	0	0
Busy Tone	480	620	500	500	0	0
Ring-Back Tone	440	480	1000	2000	0	0

Moreover, users can use CPT Auto Detect to detect CPT parameters. Instructions are shown in the following section. The method to detect CPT are as followed.

### UDT Detection

If the CPT auto detect function is not able to determine whether or not a PSTN-call receiving party has hung up the phone, then the UDT detection function can serve as a back up. To do this, enter the high/low frequency parameters from the CPT table into the UDP table.

Disable UDT	UDT Setting	# 1 Disable	# 2 Disable	# 3 Disable	# 4 Disable
Congestion Tone / Busy Tone	Low Frequency	0	0	0	0
	High Frequency	0	0	0	0

**NOTE: To cope with different local PSTN and different PBX models, the system provides CPT Auto**

Detect function to prevent the FXO from engaging a line. However, if the line of the receiving party is engaged and his/her PSTN uses a voice prompt to replace the traditional beep sound, then the system would not be able to detect a busy tone. Drop Inactive Call should then be used to determine whether or not to end the call.

#### CPT Auto Detect

- 2 PSTN phone numbers or 2 PBX extension lines are needed.
- Connect one of the phone sets to the FXO port (P3 or P4 of MODEL 2S20).
- The line of "Dial Number" must be hook on. Set the outgoing phone number the same as the phone line that is in use as above, and click the "Accept" button to start detection.
- If detection is successful, the parameters obtained will automatically be inserted into the CPT parameter.
- Save settings and restart the system.

#### Detailed description is given below:

Click "CPT auto detect" at the bottom of Trunk CPT Settings.

[Use CPT auto detect](#)

If CPT auto detect is used, the function would halt every operation of the Gateway. Select "**I am sure of it**", and then click the "Accept" button. Wait for 15 seconds, and then you will enter CPT auto detect window.

**Use CPT auto detect**

This function would halt every operation of the Gateway  
 **I am sure of it**

## Direct Connection to PSTN

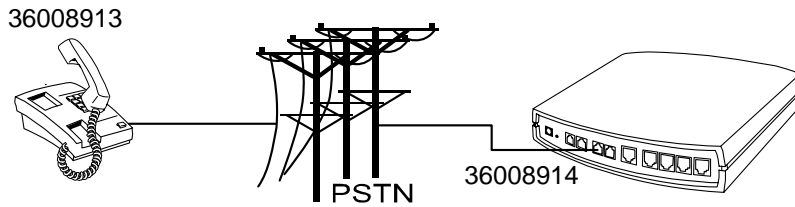

CPT Auto Detect	
<a href="#">System Operation</a>	
Tone	Detect Time
<input checked="" type="checkbox"/> Dial Tone	9 [5 - 15 s]
<input checked="" type="checkbox"/> Congestion Tone	9 [5 - 15 s]
<input checked="" type="checkbox"/> Busy Tone	9 [5 - 15 s]
Detect Channel(3 - 4)	3
Phone Number	36008914
Dial Number	36008913
Save detect value to CPT group	2

- Connect one of the trunk lines to the Gateway FXO Port (For MODEL 2S2O, please connect to P3).
- The line of "Dial Number" (36008913) must be hook on.
- Detect Channel: Enter 3 (The trunk line is connected to P3, and uses P3 for outgoing detection).
- Phone Number: Enter the number of the FXO line.
- Dial Number: Enter the number of the end to be tested—36008913.
- CPT group: Enter the group that after testing to replace with.
- Finally, click the "Accept" button.



## Connected to a PBX Extension Line

If the gateway is connected to a PBX extension line, then the busy tone of both the PBX and the PSTN must be detected.

## Connecting to a PBX extension line and detecting the busy tone of the PBX

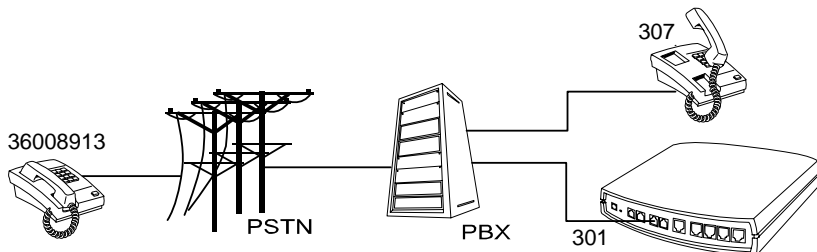

CPT Auto Detect	
<a href="#">System Operation</a>	
Tone	Detect Time
<input checked="" type="checkbox"/> Dial Tone	9 [5 - 15 s]
<input checked="" type="checkbox"/> Congestion Tone	9 [5 - 15 s]
<input checked="" type="checkbox"/> Busy Tone	9 [5 - 15 s]
Detect Channel(3 - 4)	3
Phone Number	301
Dial Number	307
Save detect value to CPT group	2

- Connect one of the PBX extension lines to the Gateway FXO Port (For MODEL 2S20, connect the line to P3).
- Detect Channel: Enter 3 (The trunk line is connected to P3, and uses P3 for outgoing detection).
- Phone Number: Set the number of FXO line –to detect Reorder Tone.
- Dial Number: Enter the number of the end to be tested—307.
- Save detect value to CPT group: Enter the group that after testing to replace with.

Finally, click the “Accept” button.

Detection in Progress: during detection, the following windows will appear.

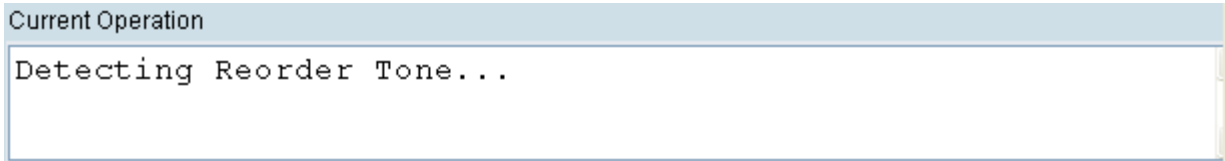

Once detection of a busy tone is in progress, the system will dial the number to be tested (in this case 36008913). After it rings pick up the phone and enter"#", then hang up. The system will then detect a busy tone automatically.

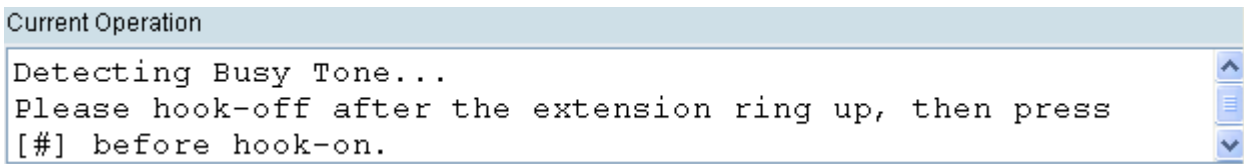

After detecting it will be as below:

### CPT Auto Detect

Detect again	Detection Value					
Tone	Low Frequency	High Frequency	T_ON_1	T_OFF_1	T_ON_2	T_OFF_2
Dial Tone	400	0	3000	0	0	0
Congestion Tone	400	0	250	250	0	0
Busy Tone	400	0	250	250	0	0

#2	Current Value					
Tone	Low Frequency	High Frequency	T_ON_1	T_OFF_1	T_ON_2	T_OFF_2
Dial Tone	350	420	300	100	3500	100
Congestion Tone	400	0	250	250	0	0
Busy Tone	400	0	500	500	0	0

If you sure overwrite Current Value, please click Accept

## Filling in the CPT Table

Fill in the table after the detection is completed as below, where the values are the frequency and On-and-Off ratio detected. Please click the "Accept" button. If connecting Gateway to a PBX extension line, please do not set the detected busy tone of the PBX and the PSTN in the same set, otherwise the value detected the first time will be overwritten.

<a href="#">Detect again</a>	Detection Value					
Tone	Low Frequency	High Frequency	T_ON_1	T_OFF_1	T_ON_2	T_OFF_2
Dial Tone	400	0	3000	0	0	0
Congestion Tone	400	0	250	250	0	0
Busy Tone	400	0	250	250	0	0

#2	Current Value					
Tone	Low Frequency	High Frequency	T_ON_1	T_OFF_1	T_ON_2	T_OFF_2
Dial Tone	350	420	300	100	3500	100
Congestion Tone	400	0	250	250	0	0
Busy Tone	400	0	500	500	0	0

If you sure overwrite Current Value, please click Accept

## Save Settings

Save the new parameters and restart the system after the test is completed. Then click the "Accept" button. Gateway will use the new parameter to detect whether a call has ended.

System Operation	
<a href="#">Detect again</a>	
<input type="checkbox"/> Save Settings	Save all configurations.
Be sure to save all settings before restart.	
<input type="checkbox"/> Restart	Restart the Gateway right away. All calls will be DROPPED when Restart.

## System Information

This page shows that the status of VoIP Gateway. There are Port Status, Server Registration Status, WAN Port Information, LAN Port Information and Hardware.

System Information							
Port Status							
No	Type	Extension Number	Line Status	Calls	Dialed Number	Proxy Register	UPnP on RTP
1	FXS	701	Idle	0		Disabled	
2	FXS	702	Idle	0		Disabled	
3	FXO	703	Idle	0		Disabled	
4	FXO	704	Idle	0		Disabled	
SIP Proxy Hunting Number Registration				FXS Disabled (00:00:19), FXO Disabled (00:00:19)			
Server Registration Status							
DDNS Registration				Disabled (00:00:19)			
Phone Book Manager Registration				Disabled (00:00:19)			
STUN Registration				Disabled (00:00:19)			
UPnP Negotiation				Disabled (00:00:19)			
WAN Port Information							
Factory Default MAC Address				00 AA BB CC DD 00			
IP Address				192.168.1.2			
Subnet Mask				255.255.255.0			
Default Gateway				192.168.1.254			
DNS				168.95.1.1			
LAN Port Information							
MAC Address				00 AA BB CC DD 01			
IP Address				192.168.8.254			
Subnet Mask				255.255.255.0			
DHCP Server							
DHCP Server				Enabled			
IP Pool Range				192.168.8.1 - 192.168.8.250			
Lease Time				1 hour(s)			
DNS				168.95.1.1			
Hardware							

- Port Status: It includes if each port registers to Proxy successfully, the lasted dialed number, how many calls each port had since the system is start, etc.
- Server Registration Status: It shows the registration status of DDNS, Phone Book Manager, STUN and UPnP.
- WAN Port Information: It shows IP address, subnet mask, default gateway and DNS server. If you use PPPoE to obtain IP, you can know if the IP is obtained through this.
- LAN Port Information: It shows LAN port IP, subnet mask, and the status of DHCP server.
- Hardware: It shows the hardware platform.

## RTP Packet Summary

Displays the information of the last finished call. It contains peer IP, peer port, packets sent, packet received and packet lost. Press the button of **Refresh** to get the latest RTP Packet Summary.

RTP Packet Summary				
Line 1	G.723.1 6.3kbps	Packet Sent 61	Packet Received 43	Packet Lost N/A
	The last packet's source IP 192.168.100.199		The last packet's source Port 9000	
Line 2	G.729A 8kbps	Packet Sent 6	Packet Received 155	Packet Lost N/A
	The last packet's source IP 192.168.100.181		The last packet's source Port 9008	
Line 3	G.729A 8kbps	Packet Sent 12	Packet Received 168	Packet Lost N/A
	The last packet's source IP 192.168.100.181		The last packet's source Port 9004	
Line 4	G.729A 8kbps	Packet Sent 5	Packet Received 153	Packet Lost N/A
	The last packet's source IP 192.168.100.181		The last packet's source Port 9006	

## STUN Inquiry

Use STUN Inquiry to know what NAT type of the router.

NAT Type	Unknown
STUN Server IP / Domain	<input type="text"/>
STUN Server Port [1 - 65535]	<input type="text" value="3478"/>

## Ping Test

Use "ping" to identify if the remote peer is reachable. Fill in remote IP address and click "Test" will start the test.

Ping Destination	<input type="text"/>
Number of Ping [1 - 100]	<input type="text" value="4"/>
Ping Packet Size [56 - 5600 bytes]	<input type="text" value="56"/>
<input type="button" value="Test"/> <input type="button" value="Stop"/>	

## SNMP

Enable SNMP Agent	<input type="checkbox"/>
Get Community	<input type="text"/>
Set Community	<input type="text"/>
Trap Community	<input type="text"/>
Trap Host	<input type="text"/>

- Enable SNMP Agent: Enable SNMP if ticked.
- Get/Set/Trap Community: Enter Community name to Read, Write and Trap.
- Trap Host: Enter the IP of Trap Host.

## NTP

This is the time setting. After the gateway is on the Internet, it will set its watch with Time Server.

	Year	Month	Day	Hour	Minute	Second
Gateway Time	<input type="text" value="2000"/>	<input type="text" value="1"/>	<input type="text" value="1"/>	<input type="text" value="9"/>	<input type="text" value="18"/>	<input type="text" value="36"/>
Time Zone	+ <input type="text" value="8"/> : <input type="text" value="00"/>					
#	Time Server					
1	<input type="text" value="ntp.ucsd.edu"/>					
2	<input type="text" value="ntp.univ-lyon1.fr"/>					
3	<input type="text" value="time.nuri.net"/>					

- Time Zone: Set the Time Zone where the gateway resides.
- Time Server #1~#3: Set the Time Server where the gateway should sync up during start up. (NTP protocol)

## Backup/Restore

You can backup settings to a file and restore settings from that file. You also can restore all settings back to default by selecting **Restore Default Configurations** and click **Restore**.

**Note: It needs to Save Settings and Restart, and all settings will back up default settings or have new setting that you upload.**

Backup Configurations	
Configuration File	<input type="button" value="Backup"/>
Configuration Template File	<input type="button" value="Backup"/>

- Configuration File: Backup the all settings.
- Configuration Template File: Backup the settings as template file for editing.

Restore Configurations	
<input checked="" type="radio"/> Upload Configuration File	<input type="text"/> <input type="button" value="Browse..."/>
<input type="radio"/> Restore Default Configurations	
<input type="button" value="Restore"/>	

## Provision Settings

Fill in the parameters needed of Provision Server from your provider.

Enable Auto Provisioning	<input type="checkbox"/>
Provision Server Address	<input type="text"/>
Port [1 - 65535]	<input type="text" value="10101"/>
Packet Format	Proprietary <input type="button" value="v"/>
Connect Provision Server During Start Up	<input checked="" type="checkbox"/>
Connect Provision Server Periodically	<input checked="" type="checkbox"/>
Auto Provision Interval [60 - 604800 s]	<input type="text" value="10800"/> Random Offset [1 - 1800 s] <input type="text" value="600"/>
Provision Retry Times [0=always, 1 - 99] [0 - 99]	<input type="text" value="10"/>
Retry Interval [30 - 120 s]	<input type="text" value="30"/>
Suspend Service	<input type="checkbox"/>

## System Operations (Save Settings)

Some settings are effective by **Restart**. Remember to save all settings by **Save Settings** before to restart.

<input type="checkbox"/> Save Settings	Save all configurations.
<b>Be sure to save all settings before restart.</b>	
<input type="checkbox"/> Restart	Restart the Gateway right away. All calls will be DROPPED when Restart.

- Save Settings: Save settings after completing. The new settings will take effect after the system is restarted. Please select "Save Settings".
- Restart: If it is necessary to restart the system, please select "Restart" and click the "Accept" button.

## Software Upgrade

Gateway provides software upgrade function for a remote end.  
Your provider gives all parameters.

To Save Current Settings, [Save Settings](#)

**Current Software Version No. [1.2.33.7]**

Upgrade Server	<input checked="" type="radio"/> TFTP <input type="radio"/> FTP <input type="radio"/> Image Server
Software Upgrade Server IP	<input type="text"/>
Software Upgrade Server Port [1 - 65535]	<input type="text" value="69"/>
User Name	<input type="text"/>
Password	<input type="text"/>
Directory	<input type="text"/>

All calls will be DROPPED during upgrade.

- Upgrade Server: Choose the server type of your provider.
- Software Upgrade Server IP: Enter the software server IP address.
- Software Upgrade Server Port: Enter the port that server uses. TFTP is 69, and FTP is 21.
- User Name/ Password: The account to access FTP server.
- Directory: The path of TFTP or FTP.

## Logout

Gateway only allows one user to login at a time, so whenever a change is made, please save the settings, restart the system, or logout to avoid the situation where other users cannot login to change settings.

To save settings, click [Here](#)



## 5. IP Sharing Functions

---

All Gateway series have a built-in IP sharing function. The settings and instructions at a PC end are described below:

Current Intranet only supports static IP mode, and the settings at the PC end are as follow:  
Available IP address Range : 192.168.8.1 – 192.168.8.253 (default address of Gateway is 192.168.8.254)

Subnet Mask : 255.255.255.0  
Default Gateway : 192.168.8.254

**The above values vary with different LAN Port Settings.**

**Assume Gateway's LAN settings are,**

**IP address : 192.168.3.1**

**Subnet Mask : 255.255.255.0**

**Then, the settings at PC end should be as follows:**

**Valid IP address range : 192.168.3.2 – 192.168.3.254**

**Subnet Mask : 255.255.255.0**

**Default Gateway : 192.168.3.1**

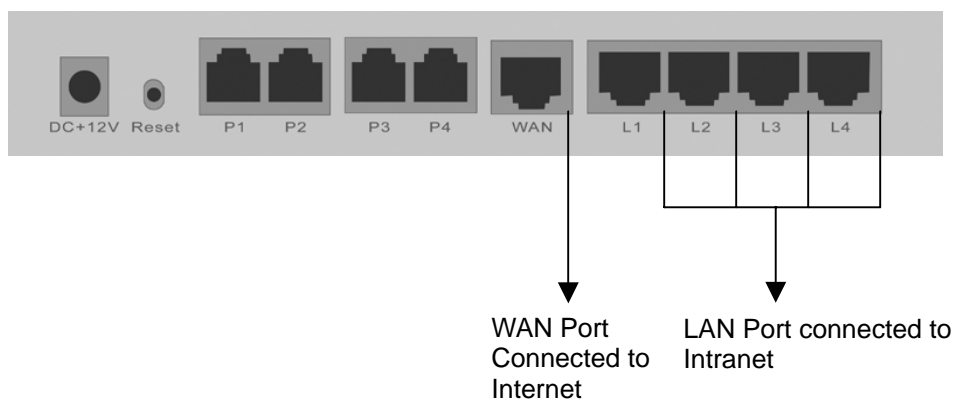

The IP settings on PC are as follows (using Windows 2000 for example)  
Open Start->Settings->**Control Panel**  
Open **Network and Dial-up Connection**

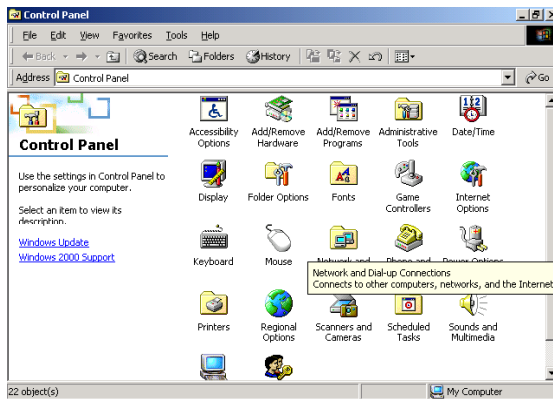

Open **Local Area Connection**

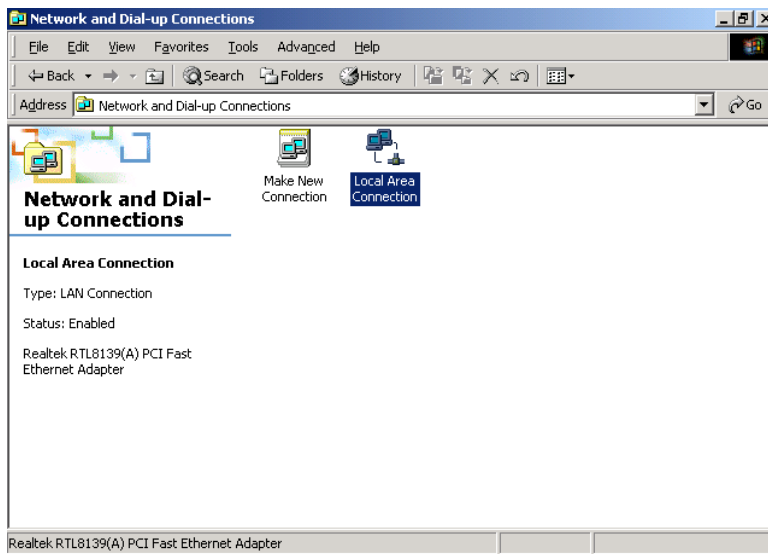

Click **Properties**

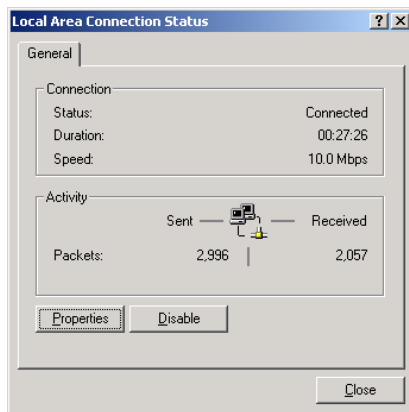

Select **TCP/IP**, and then click **Properties**.

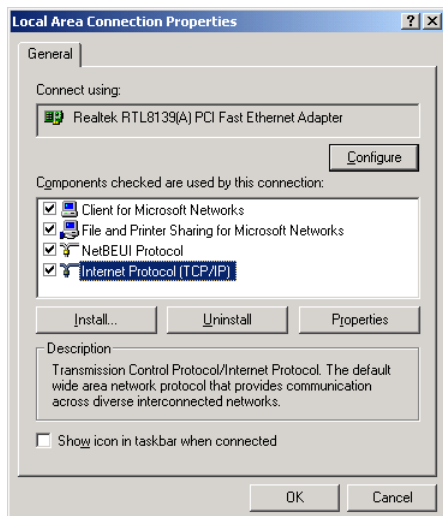

Select **“Use the following IP Address ”** and enter IP address, Subnet Mask, and Default Gateway. Please note that an IP address in the same domain cannot be reused. Then, enter the DNS server IP address (varies in different networks. consult your ISP’s service for information). Click the **“OK”** button and after completing the settings, users can use both the VoIP and network services concurrently.

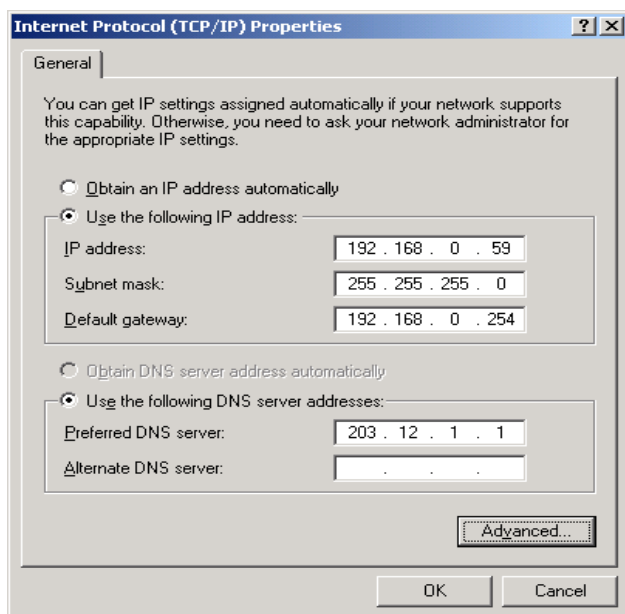

## 6. Coding Principle

---

### Instruction

- After a phone number is entered, dial # to call out immediately or, wait until the “Inter DTMF Timeout” expires (defined in “Advanced Options”, default=4 seconds).
- If the phone number fits the setting of Digit Map, the gateway dials out the phone number through the assigned interface automatically.
- The phone number should have at least 2 digits (not including \* and #).

### Dialed Number Processing Flow

To maintain maximum flexibility, the number dialed will be looked up from several tables defined in the gateway. Once no match can be found, it will look up again from the registered SIP Proxy Server. The look up flow is shown below:

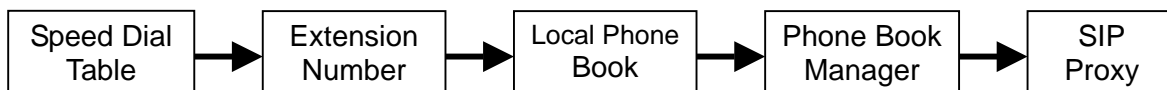

A complete flow chart is on the next page.

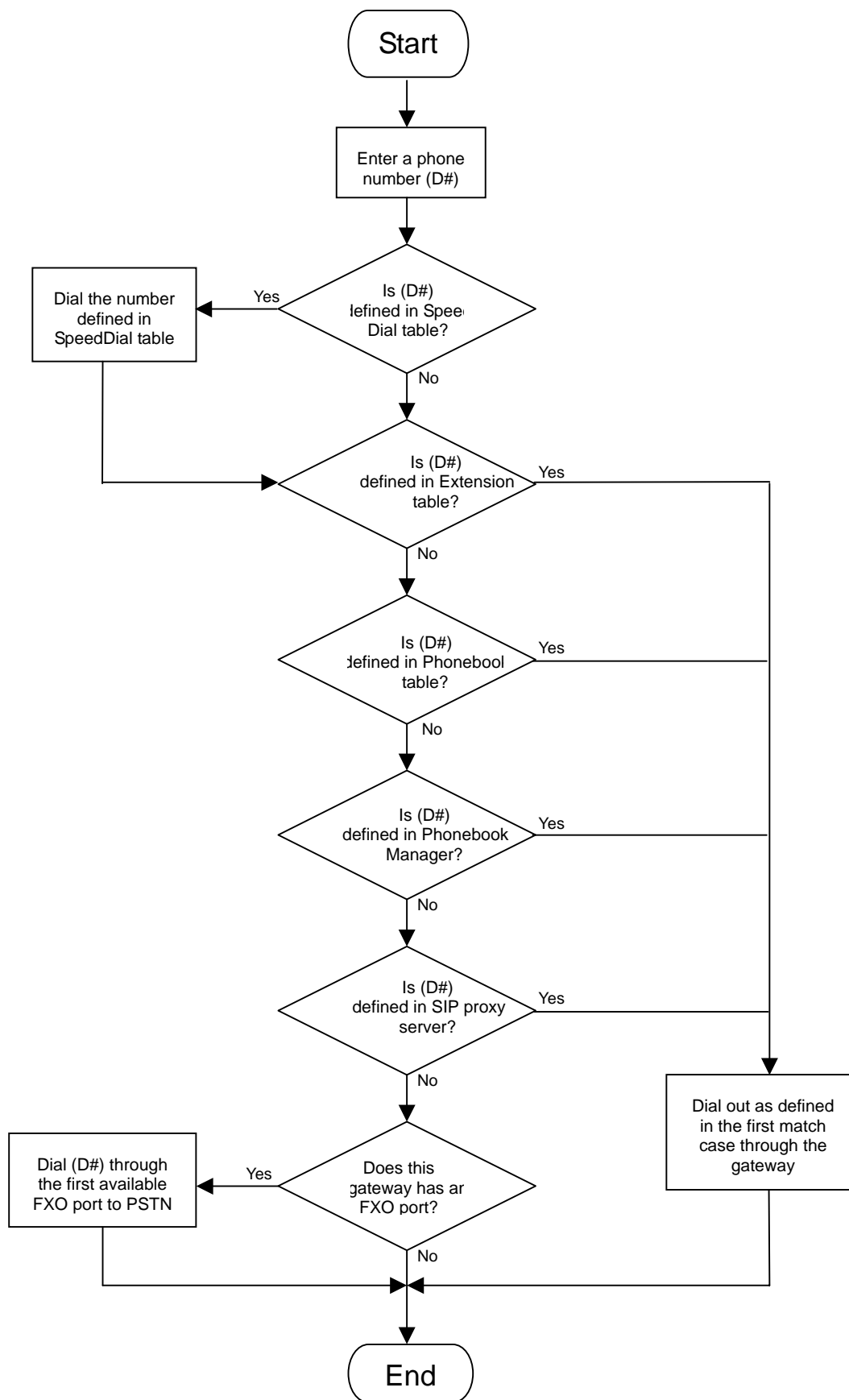

# 7. Advanced Feature

---

## Static Route✘

Build static routes within an internal network. These routes will not apply to the Internet.

#	Route	Route Mask	Next Hop IP	Interface
1	<input type="text"/>	<input type="text"/>	<input type="text"/>	<input type="text"/>
2	<input type="text"/>	<input type="text"/>	<input type="text"/>	<input type="text"/>
3	<input type="text"/>	<input type="text"/>	<input type="text"/>	<input type="text"/>
4	<input type="text"/>	<input type="text"/>	<input type="text"/>	<input type="text"/>
5	<input type="text"/>	<input type="text"/>	<input type="text"/>	<input type="text"/>

- Route: Enter the IP of the specified network.
- Route Mask: Enter the subnet mask to be used for the specified network.
- Next Hop IP: Enter the IP address to the specified network.
- Inter Face: Select the inter face.

## RIP(Routing Information Protocol) ✘

Establish dynamic routes within an internal network. These routes will not apply to the Internet.

Enable RIP	<input type="checkbox"/>
Send Version	1&2 <input type="text"/>
Receive Version	1&2 <input type="text"/>
Enable Authentication	<input type="checkbox"/>
Authentication Password	••••••••
Update Timer	30 <input type="text"/>
Timeout Timer	180 <input type="text"/>
Garbage Timer	120 <input type="text"/>

- Enable Authentication/Authentication Password: All the boxes in this RIP group should be filled in the same password if ticked.

## Port filtering

Port filtering enables you to control all data that can be transmitted in routers; **principles of filtering---When the port used at the source end is within the limited scope, it will be filtered without transmission.**

Enable Port Filtering <input type="checkbox"/>		
Port Range	TCP / UDP	Remark
0 - 0	Both <input type="button" value="v"/>	
0 - 0	Both <input type="button" value="v"/>	
0 - 0	Both <input type="button" value="v"/>	

- Enable port filtering: whether to enable this function or not.
- Port Range: Set the range of port to be filtered, suppose it is 80 and when use protocol is Both or TCP, all computers will be unable to use the services of http (port 80)— will be unable to browse normal WebPages.
- TCP/UDP: Choose to either filter TCP or UDP, or choose to filter both.
- Remark: Remark field, you can write comments by yourself.

## IP Filtering

IP Filtering is to limit internal users from accessing the Internet.

Enable IP Filtering <input type="checkbox"/>		
IP	TCP / UDP	Remark
	Both <input type="button" value="v"/>	
	Both <input type="button" value="v"/>	
	Both <input type="button" value="v"/>	

- IP: Input the IP address that you want to filter; the limited IP address will be unable to transmit the data to the Internet.
- TCP/UDP: Choose to either filter TCP or UDP, or choose to filter both.
- Remark: Remark filed, you can write comments by yourself.

## MAC Filtering

**MAC (Media Access Control)** address filtering is to filter the transmission of data by network card physical address.

Enable MAC Filtering <input type="checkbox"/>	
MAC	Remark
<input type="text"/>	<input type="text"/>
<input type="text"/>	<input type="text"/>
<input type="text"/>	<input type="text"/>

MAC: input MAC that will limit accessing Internet PC.

## Virtual Server

Enabling the users on Internet to access the WWW, FTP and other services under your NAT. When remote user are accessing Web or FTP servers through WAN end IP address, it will be routed to the server at the internal LAN end and be routed to the server at the internal LAN end as appropriate in accordance with the externally required services

Enable Virtual Server <input type="checkbox"/>					
WAN Port Range	TCP / UDP	LAN Host IP Address	Server Port Range	Remark	
<input type="text"/> - <input type="text"/>	Both <input type="button" value="v"/>	<input type="text"/>	<input type="text"/> - <input type="text"/>	<input type="text"/>	
<input type="text"/> - <input type="text"/>	Both <input type="button" value="v"/>	<input type="text"/>	<input type="text"/> - <input type="text"/>	<input type="text"/>	
<input type="text"/> - <input type="text"/>	Both <input type="button" value="v"/>	<input type="text"/>	<input type="text"/> - <input type="text"/>	<input type="text"/>	

- WAN Port Range: Input the port on the WAN side.
- TCP/UDP: Select the communication protocols used by the server—TCP or UDP.
- LAN Host IP Address: Input IP address that provides various services servers.
- Server Port Range: Input the port used by the LAN host.

## DMZ

Lets the server on the LAN to be directly exposed to the Internet for accessing data. Either this function or the virtual server can be selected for use.

Enable DMZ <input type="checkbox"/>
DMZ Host IP Address <input type="text"/>



## URL Filter✳

URL filter is used to deny device from LAN accessing specific web sites. The system will block the URL that contains the string.

Enable	URL string pattern to be blocked	Source IP Range	
<input type="checkbox"/>	<input type="text"/>	<input type="text" value="0.0.0.0"/>	- <input type="text" value="0.0.0.0"/>
<input type="checkbox"/>	<input type="text"/>	<input type="text" value="0.0.0.0"/>	- <input type="text" value="0.0.0.0"/>
<input type="checkbox"/>	<input type="text"/>	<input type="text" value="0.0.0.0"/>	- <input type="text" value="0.0.0.0"/>

## Special Applications✳

Provide multiple connections for special applications.

Enable	Name	Incoming Type	Incoming Port Range	Trigger Type	Trigger Port Range	
<input type="checkbox"/>	MSN Gaming Zone	BOTH ▾	2300-2400,28800-29000	TCP ▾	<input type="text" value="47624"/>	- <input type="text" value="47624"/>
<input type="checkbox"/>	Quick Time	TCP ▾	6970-6999	TCP ▾	<input type="text" value="554"/>	- <input type="text" value="554"/>
<input type="checkbox"/>	ICU II	BOTH ▾	2000-2038,2050-2051,2069,208	TCP ▾	<input type="text" value="2019"/>	- <input type="text" value="2019"/>
<input type="checkbox"/>	PC-to-Phone	TCP ▾	12120,12122,24150-24220	TCP ▾	<input type="text" value="12053"/>	- <input type="text" value="12053"/>
<input type="checkbox"/>	<input type="text"/>	TCP ▾	<input type="text"/>	TCP ▾	<input type="text" value="0"/>	- <input type="text" value="0"/>
<input type="checkbox"/>	<input type="text"/>	TCP ▾	<input type="text"/>	TCP ▾	<input type="text" value="0"/>	- <input type="text" value="0"/>
<input type="checkbox"/>	<input type="text"/>	TCP ▾	<input type="text"/>	TCP ▾	<input type="text" value="0"/>	- <input type="text" value="0"/>
<input type="checkbox"/>	<input type="text"/>	TCP ▾	<input type="text"/>	TCP ▾	<input type="text" value="0"/>	- <input type="text" value="0"/>

- Name: The name of the special application.
- Incoming Type: The protocol used to trigger the special application.
- Incoming Port range: Port range on the WAN side that will be used to access the application.
- Trigger Type: The protocol used to trigger the application.
- Trigger Port Range: Port range used to trigger the application.

## DoS Prevention Settings✘

Enable DoS Prevention	<input checked="" type="checkbox"/>
Enable DoS Prevention on LAN	<input checked="" type="checkbox"/>
Whole System Flood	<input checked="" type="checkbox"/> SYN <input type="text" value="50"/> (Packets/Second) [50 - 500]
	<input checked="" type="checkbox"/> FIN <input type="text" value="50"/> (Packets/Second) [50 - 500]
	<input type="checkbox"/> UDP <input type="text" value="68"/> (Packets/Second)
	<input checked="" type="checkbox"/> ICMP <input type="text" value="50"/> (Packets/Second) [50 - 500]
Per-Source IP Flood	<input checked="" type="checkbox"/> SYN <input type="text" value="30"/> (Packets/Second) [30 - 300]
	<input checked="" type="checkbox"/> FIN <input type="text" value="30"/> (Packets/Second) [30 - 300]
	<input type="checkbox"/> UDP <input type="text" value="68"/> (Packets/Second)
	<input checked="" type="checkbox"/> ICMP <input type="text" value="30"/> (Packets/Second) [30 - 300]
TCP / UDP Port Scan	<input type="checkbox"/> TCP / UDP Port Scan Level <input type="text" value="Low"/>
TCP Scan	<input type="checkbox"/>
TCP SYN with Data	<input type="checkbox"/>
TCP Land	<input type="checkbox"/>
UDP Echo Chargen	<input type="checkbox"/>
UDP Bomb	<input type="checkbox"/>
UDP Land	<input type="checkbox"/>
Ping of Death	<input checked="" type="checkbox"/>
ICMP Smurf	<input checked="" type="checkbox"/>
ICMP Land	<input checked="" type="checkbox"/>
IP Spoof	<input type="checkbox"/>
Tear Drop	<input type="checkbox"/>

- Enable DoS Prevention: To prevent DoS from WAN.
- Enable DoS Prevention on LAN: To prevent DoS from LAN.

Source Blocking	
Enable Source IP Blocking	<input type="checkbox"/>
Blocking Time [2 - 600 s]	<input type="text" value="120"/>

- Enable Source IP Blocking: Block the IP.
- Blocking Time: The time to block the IP.