



CABLE

SATELLITE

TELECOM

TERRESTRIAL

## DCW775 - Wireless Gateway

User manual

**THOMSON**

## Chapter 1: Connections and Setup

### CAUTION

Disconnect power before servicing.

### CAUTION

To ensure reliable operation and to prevent overheating, provide adequate ventilation for this modem and keep it away from heat sources. Do not locate near heat registers or other heat-producing equipment. Provide for free air flow around the Wireless Gateway and its power supply.



*This symbol means that your inoperative electronic appliance must be collected separately and not mixed with the household waste. The European Union has implemented a specific collection and recycling system for which producers are responsible.*

*This appliance has been designed and manufactured with high quality materials and components that can be recycled and reused. Electrical and electronic appliances are liable to contain parts that are necessary in order for the system to work properly but which can become a health and environmental hazard if they are not handled or disposed of in the proper way. Consequently, please do not throw out your inoperative appliance with the household waste.*

*If you are the owner of the appliance, you must deposit it at the appropriate local collection point or leave it with the vendor when buying a new appliance.*

*- If you are a professional user, please follow your supplier's instructions.*

*- If the appliance is rented to you or left in your care, please contact your service provider.*

*Help us protect the environment in which we live !*

### **NORTH AMERICAN CABLE INSTALLER:**

This reminder is provided to call your attention to Article 820-40 of the National Electrical Code (Section 54 of the Canadian Electrical Code, Part 1) which provides guidelines for proper grounding and, in particular, specifies that the cable ground shall be connected to the grounding system of the building as close to the point of cable entry as practical.

# Important Information

## DOCSIS compliant

This product was designed according to Data over Cable Service Interface Specifications.

## Operating Information

Operating Temperature: 0° C to 40° C (32° F ~ 104° F)

Storage Temperature: -20° C to 70° C (-4° F ~ 158° F)

If you purchased this product at a retail outlet, please read the following:

## Product Information

Keep your sales receipt to obtain warranty parts and service and for proof of purchase. Attach it here and record the serial and model numbers in case you need them. The numbers are located on the back of the product.

Model No. \_\_\_\_\_ Serial No \_\_\_\_\_

Purchase Date: \_\_\_\_\_ Dealer/Address/Phone: \_\_\_\_\_

# List of Figures

<b>Chapter 1: Connections and Setup</b> .....	2
<b>Introduction</b> .....	2
<b>Wireless Gateway Features</b> .....	2
<b>What's on the CD-ROM</b> .....	2
<b>DOCSIS is trademarks of Cable Television Laboratories, Inc.</b> .....	3
<b>Computer Requirements</b> .....	3
<b>Wall Mounting</b> .....	4
<b>Wireless Gateway DCW775 Overview</b> .....	5
<b>Front Panel</b> .....	5
<b>Rear Panel</b> .....	7
<b>Side Panel</b> .....	7
<b>Relationship among the Devices</b> .....	8
<b>What the Modem Does</b> .....	8
<b>What the Modem Needs to Do Its Job</b> .....	8
<b>Contact Your Local Cable Company</b> .....	8
<b>Connecting the Wireless Gateway to a Single Computer</b> .....	10
<b>Attaching the Cable TV Wire to the Wireless Gateway</b> .....	10
<b>Important Connection Information</b> .....	11
<b>Ethernet Connection to a Computer</b> .....	11
<b>Connecting More Than One Computer to the Wireless Gateway</b> .....	12
<b>Turning on the Wireless Gateway</b> .....	13
<b>Chapter 2: WEB Configuration</b> .....	14
<b>Accessing the Web Configuration</b> .....	14
<b>Outline of Web Manager</b> .....	15
<b>Status</b> .....	16
<b>1. Software</b> .....	16

## List of Figures

2. Connection.....	17
3. Password.....	18
4. Diagnostics.....	19
5. Event Log .....	20
6. Switch Mode.....	20
7. Backup/Restore .....	21
Network.....	22
1. LAN .....	22
2. WAN.....	23
3. Computers .....	24
4. DDNS .....	25
5. Time.....	26
Advanced .....	27
1. Options .....	27
2. IP Filtering .....	28
3. MAC Filtering .....	29
4. Port Filtering .....	30
5. Forwarding.....	31
6. Port Triggers .....	32
7. DMZ Host .....	33
8. RIP (Routing Information Protocol) Setup .....	34
Firewall .....	35
1. Web Filtering.....	35
2. TOD Filtering.....	36
3. Local Log and Remote Log .....	37
Parental Control .....	38

# List of Figures

1. Basic.....	38
Wireless.....	39
1. 802.11/ Radio .....	40
2. 802.11/ Primary Network.....	42
3. Access Control.....	49
4. Bridging.....	50
5. 802.11 QoS (WMM) Settings .....	51
Chapter 3: Networking.....	53
Communications .....	53
Type of Communication .....	53
Cable Modem (CM) Section .....	54
Networking Section.....	54
Three Networking Modes .....	55
Cable Modem (CM) Mode.....	55
Residential Gateway (RG) Mode.....	57
CableHome (CH) Mode .....	58
MAC and IP Addresses Summary.....	60
Chapter 4: Additional Information .....	61
Frequently Asked Questions .....	61
General Troubleshooting .....	63
FCC Declaration of Conformity and Industry Canada Information .....	64
Service Information .....	65
Glossary .....	66

# Chapter 1: Connections and Setup

## Chapter 1: Connections and Setup

### Introduction

---

#### Wireless Gateway Features

- CableLabs DOCSIS 1.0/1.1/2.0/3.0 Standard Compliant
- 4 x Standard RJ-45 connector for 10/100/1000 BaseT Ethernet with auto-negotiation and MDIX functions; Support maximum Ethernet cable length up to 100m (Category 5)
- 1 x Master USB connector socket comply to USB2.0
- WIFI interface 802.11n; 2,4GHz or 5 GHz with at least 2x2 antennas.
- Transparent bridging for IP traffic
- Transparent bridging between CPE and RF interface
- Transparent bridging between Ethernet and USB interface when USB is populated on the board
- RSA and 56 bit DES data encryption security
- SNMP network management support
- Remote operating firmware downloading
- Support Web pages and private DHCP server for status monitoring
- MPEG over IP encapsulation
- Power management
- Network Protocol: IP/TCP/UDP/ARP/ICMP/DHCP/FTP/TFTP/SNMP/HTTP
- Syslog (remote)
- Event Log (local)
- Clear LED display
- Reset switch in order to restore factory parameters
- Two detachable SMA antennas connectors (optional)

#### What's on the CD-ROM

Insert the Wireless Gateway CD-ROM into your CD-ROM drive to view troubleshooting tips, the internal diagnostics, and other valuable information.

#### CD-ROM Contents:

- Electronic copy of this user's guide in additional languages (PDF format)
- Adobe Acrobat Reader — application you can load to read PDF format, if you don't have it loaded already
- Links to Thomson web site

# Chapter 1: Connections and Setup

## DOCSIS is trademarks of Cable Television Laboratories, Inc. Computer Requirements

For the best possible performance from your Wireless Gateway, your personal computer must meet the following minimum system requirements (note that the minimum requirements may vary by cable companies):

	<b>IBM PC COMPATIBLE</b>	<b>MACINTOSH**</b>
CPU	Pentium preferred	PowerPC or higher
System RAM	16MB (32MB preferred)	24MB (32MB preferred)
Operating System	Windows* NT/2000/Me/XP/Vista, Linux	Mac OS** 7.6.1 or higher
Video	VGA or better (SVGA preferred)	VGA or better (SVGA built-in preferred)
Ethernet	10 /100 /1000 Base-T	10 /100 /1000 Base-T
	An Ethernet card makes it possible for your computer to pass data to and from the internet. You must have an Ethernet card and software drivers installed in your computer. You will also need a standard Ethernet cable to connect the Ethernet card to your Wireless Gateway.	
Software	<ul style="list-style-type: none"> <li>• A TCP/IP network protocol for each machine</li> <li>• Microsoft Internet Explorer 4.0 or later or Netscape Navigator 4.0 or later. (5.0 and 4.7 or later, respectively, are strongly recommended.)</li> </ul>	

\* Windows is a trademark of Microsoft Corporation.

\*\* Macintosh and the Mac OS are trademarks of Apple Computer, Inc.



# Chapter 1: Connections and Setup

## Wall Mounting

Number of screws: 2 pieces.

Direction for wall mounting: Tuner downward or leftward or rightward

Dimension for the screw: 3.5 mm; length: 10 mm.

There are 2 slots on the underside of the WIRELESS GATEWAY that can be used for wall mounting.

---

Note: When wall mounting the unit, ensure that it is within reach of the power outlet.

---

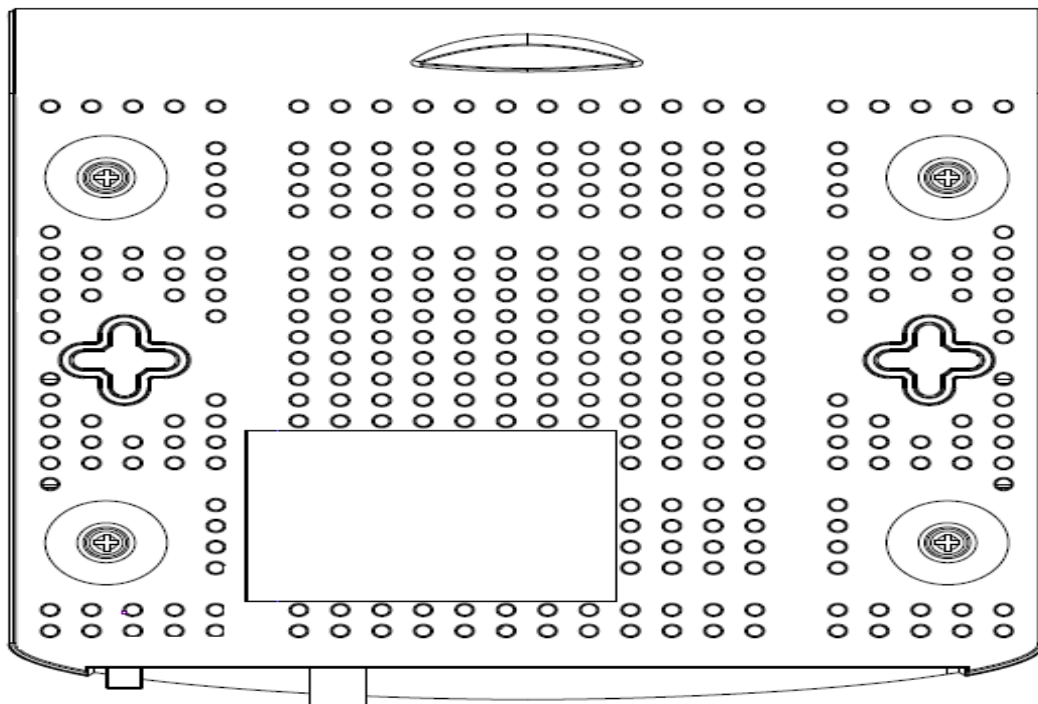

### To do this:

1. For THE WIRELESS GATEWAY, ensure that the wall you use is smooth, flat, dry and sturdy and use the 2 screws holes
2. The unit can be to use solid concrete wall and/or hard wood wall

# Chapter 1: Connections and Setup

## Wireless Gateway DCW775 Overview

---

### Front Panel

The following illustration shows the front panel of the DCW775:

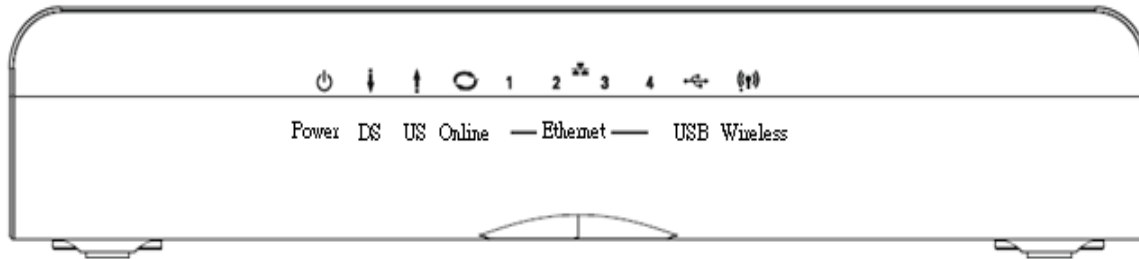

### Reset Button behavior

- Push and hold the button between 0 and 5 seconds → Reboot the device
- Between 6 and 10 seconds → Display the channel bonding status for DS and US  
Note: This is the same as the above Channel Bonding display after the registration
- After 11 seconds → Perform the factory reset.

### WPS LED is a backlight in WPS button

- When WiFi is on, the LED is blinking
- When WPS association is on, the LED is turned on

# Chapter 1: Connections and Setup

The LEDs on the front panel are described in the table below (from left to right):

DCW775	Power	Internet			Ethernet				USB	Wireless	Description
		DS	US	Online	1	2	3	4			
Boot-up Operation	ON	ON	ON	ON	ON	ON	ON	ON	X	X	Power on 0.25 sec
	X	FLASH	FLASH	FLASH	X	X	X	X	X	X	From power ON to system initialization complete
DOCSIS Start-up Operation	ON	FLASH	OFF	OFF	X	X	X	X	X	X	During DS scanning and acquiring SYNC
	ON	ON	FLASH	OFF	X	X	X	X	X	X	From SYNC completed, receiving UCD to ranging completed
	ON	ON	ON	FLASH	X	X	X	X	X	X	During DHCP, configuration file download,
	ON	ON	ON	ON	X	X	X	X	X	X	Operational (NACO=ON)
	ON	FLASH	FLASH	OFF	X	X	X	X	X	X	Operational (NACO=OFF)
Channel Bonding Operation	FLASH	FLASH	FLASH	FLASH	X	X	X	X	X	X	Wait registration with all DS and all US – Lights Flash sequentially from the right to left Minimum duration 3 seconds
	X	X	X	X	X	X	X	X	X	X	From 1 to 4 DS, from 1 to 4 LEDs are ON. From 5 to 8 DS, From 1 to 4 LEDs are flashing Duration 3 seconds
	OFF	X	X	OFF	X	X	X	X	X	X	From 1 to 2 US, from 1 to 2 LEDs are ON. From 3 to 4 US, From 1 to 2 LEDs are flashing Duration 3 seconds.
	FLASH	FLASH	FLASH	FLASH	X	X	X	X	X	X	Wait registration with all DS and all US – Lights Flash sequentially from the left to right Minimum duration 3 seconds
CPE Operation	ON	X	X	X	OFF ON FLASH	OFF ON FLASH	OFF ON FLASH	OFF ON FLASH	X	X	No Ethernet Link Ethernet Link TX/RX Ethernet Traffic
	ON	X	X	X	X	X	X	X	X	OFF ON FLASH	Wireless is disable Wireless initiate success or enable TX/RX Wireless Traffic
	ON	X	X	X	X	X	X	X	X	X	No USB Link USB Link TX/RX USB Traffic
SW Download Operation	ON	FLASH	FLASH	ON	X	X	X	X	X	X	A software download and while updating the FLASH memory

# Chapter 1: Connections and Setup

## Rear Panel

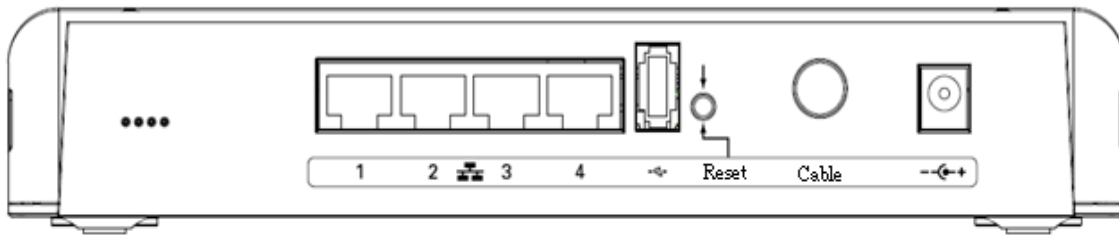

- 4 x GIGA ETHERNET: Ethernet 10/100/1000BaseT RJ-45 connector
- USB : USB 2.0 host connector
- RESET: Reset CM
- CABLE: F-Connector
- 12VDC: DC power socket

## Side Panel

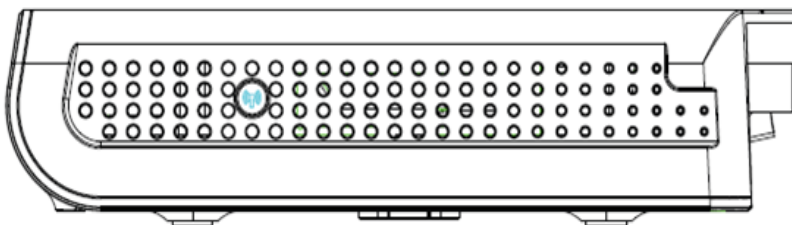

- 1 x WPS button with LED

# Chapter 1: Connections and Setup

## Relationship among the Devices

---

### What the Modem Does

The Wireless Gateway provides high-speed Internet access as well as cost-effective fax/modem services over residential, commercial, and education subscribers on public and private networks via an existing CATV infrastructure. The IP traffic can transfer between the Wireless Gateway and DOCSIS compliant headend equipment. The data security secures upstream and downstream communications.

### What the Modem Needs to Do Its Job

**The Right Cable Company:** Make sure your local cable company provides data services that use cable TV industry-standard DOCSIS compliant technology.

### Contact Your Local Cable Company

You will need to contact your cable company to establish an Internet account before you can use your gateway. You should have the following information ready (which you will find on the sticker on the gateway):

- The serial number
- The model number
- The Cable Modem (CM) Media Access Control (MAC) address
- SSID, WEP/WPA-PSK information

# Chapter 1: Connections and Setup

## **Please verify the following with the cable company**

- The cable service to your home supports DOCSIS compliant two-way modem access.
- You have a cable outlet near your PC and it is ready for Cable Modem service.

*Note: It is important to supply power to the modem at all times. Keeping your modem plugged in will keep it connected to the Internet. This means that it will always be ready whenever you need.*

### **Important Information**

Your cable company should always be consulted before installing a new cable outlet. Do not attempt any rewiring without contacting your cable company first.

# Chapter 1: Connections and Setup

## Connecting the Wireless Gateway to a Single Computer

This section of the manual explains how to connect your Wireless Gateway to the Ethernet port on your computer and install the necessary software. Please refer to Figure 1 to help you connect your Digital Cable Modem for the best possible connection.

### Attaching the Cable TV Wire to the Wireless Gateway

1. Locate the Cable TV wire. You may find it one of three ways:
  - a. Connected directly to a TV, a Cable TV converter box, or VCR. The line will be connected to the jack which should be labeled either IN, CABLE IN, CATV, CATV IN, etc.
  - b. Connected to a wall-mounted cable outlet.
  - c. Coming out from under a baseboard heater or other location. See Figure 1 for the wiring example.

*Notes: For optimum performance, be sure to connect your Wireless Gateway to the first point the cable enters your home. The splitter must be rated for at least 1GHz.*

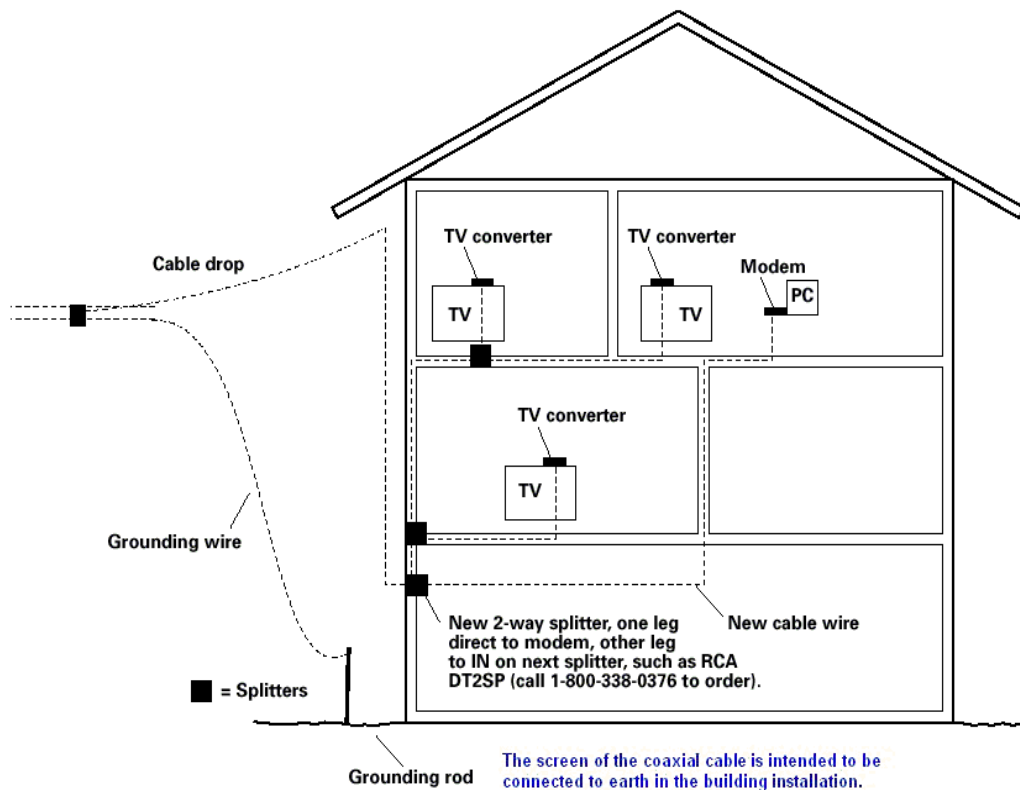

Fig. 1: Basic Home Wiring

# Chapter 1: Connections and Setup

## Important Connection Information

The Wireless Gateway supports 4 Ethernet connections simultaneously.

Below are important points to remember before you connect the Wireless Gateway.

## Ethernet Connection to a Computer

Make the connection to the modem in the following sequence:

1. Connect one end of the coaxial cable to the cable connection on the wall, and the other end to the CABLE jack on the Wireless Gateway.
2. Connect the plug from the DC power supply into the POWER DC ADAPTER jack on the Cable Wireless Gateway, and plug the power supply into a DC outlet.

*Note: Use only the power supply that accompanied this unit. Using other adapters may damage the unit.*

3. Connect one end of the Ethernet cable (straight-wired, see below) to the Ethernet port on the back of your computer, and the other end to the ETHERNET port on the Wireless Gateway.

*Make sure that the Ethernet cable is straight-wired (not “null” or crossover-wired). However, you will need a crossover-type cable if you are connecting the modem to a hub, or a hub within a port switch that provides the same function.*

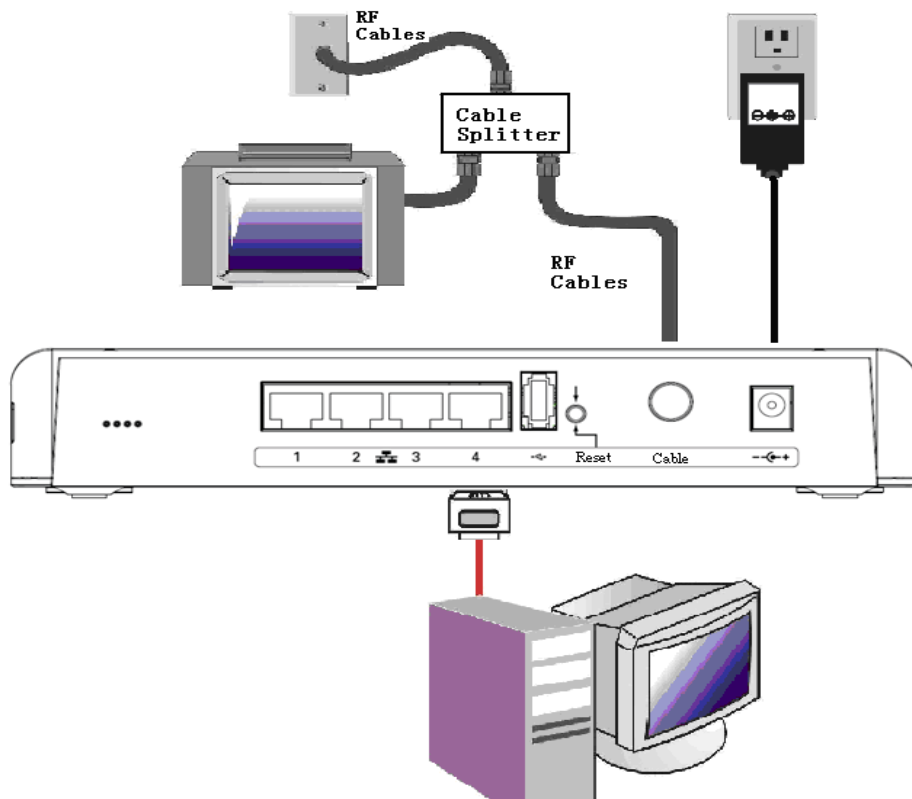

Fig.2: Ethernet Connection



# Chapter 1: Connections and Setup

## Connecting More Than One Computer to the Wireless Gateway

If you need to connect more than one computer to DCW775, simply connect the computers to the Ethernet ports on the rear panel. You may also use a hub with an crossover Ethernet cable to connect more than 4 computer to the Wireless Gateway.

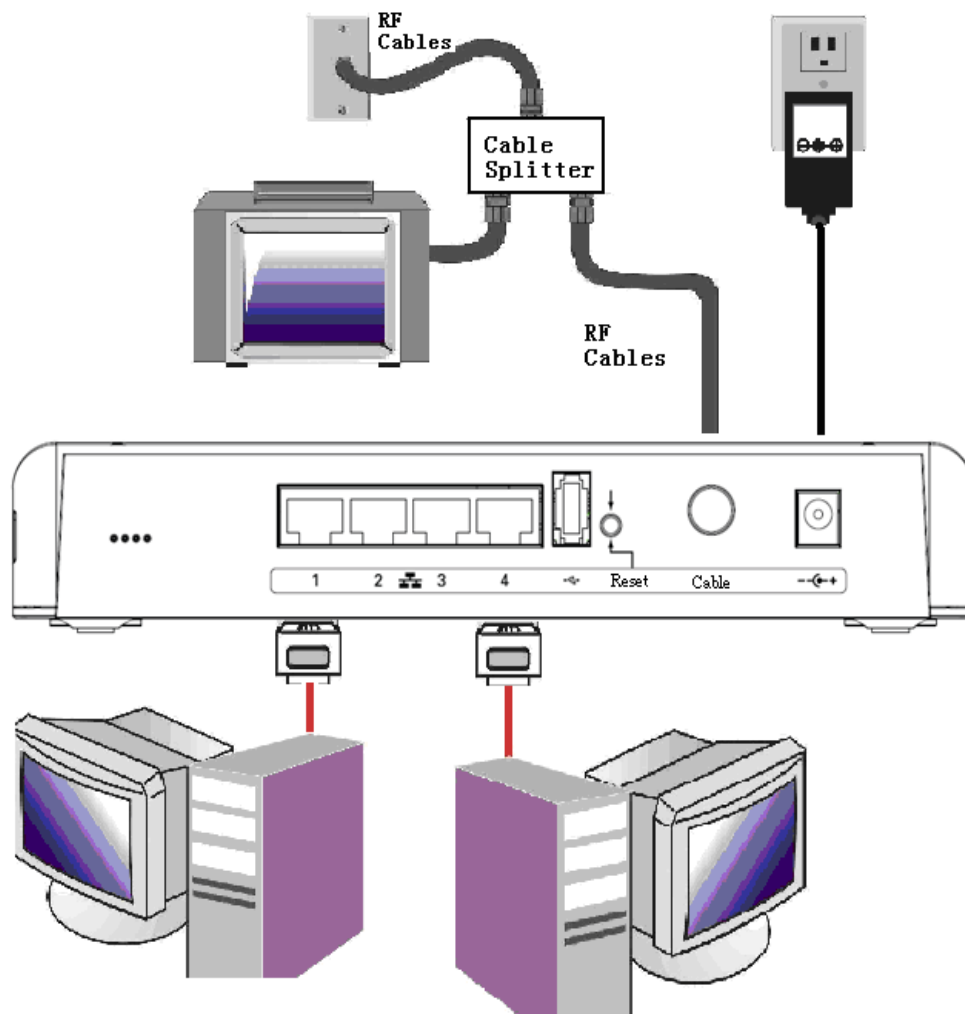

Fig.3: Multiple-PC Connection

*Note: You may need to check with your service provider in order to connect multiple computers.*

# Chapter 1: Connections and Setup

## Turning on the Wireless Gateway

---

After installing the Wireless Gateway and turn it on for the first time (and each time the modem is reconnected to the power), it goes through several steps before it can be used. Each of these steps is represented by a different pattern of flashing lights on the front of the modem.

*Note: All indicators flash once before the initialization sequence.*

If all of the lights are flashing sequentially, it means the Wireless Gateway is automatically updating its system software. Please wait for the lights to stop flashing. You cannot use your modem during this time. Do not remove the power supply or reset the Wireless Gateway during this process.

# Chapter 2: WEB Configuration

## Chapter 2: WEB Configuration

To make sure that you can access the Internet successfully, please check the following first.

1. Make sure the Ethernet connection between the Wireless Gateway and your computer is OK.
2. Make sure the TCP/IP protocol is set properly.
3. Subscribe to a Cable Company.

### Accessing the Web Configuration

---

The **Wireless Gateway** offers local management capability through a built in HTTP server and a number of diagnostic and configuration web pages. You can configure the settings on the web page and apply them to the device.

Once your host PC is properly configured; please proceed as follows:

1. Start your web browser and type the private IP address of the Wireless Gateway on the URL field: **192.168.0.1**.
2. After connecting to the device, you will be prompted to enter username and password. By default, the username is “” and the password is “**admin**”.



Fig. 4

If you login successfully, the main page will appear.

# Chapter 2: WEB Configuration

## Outline of Web Manager

The main screen will be shown as below.

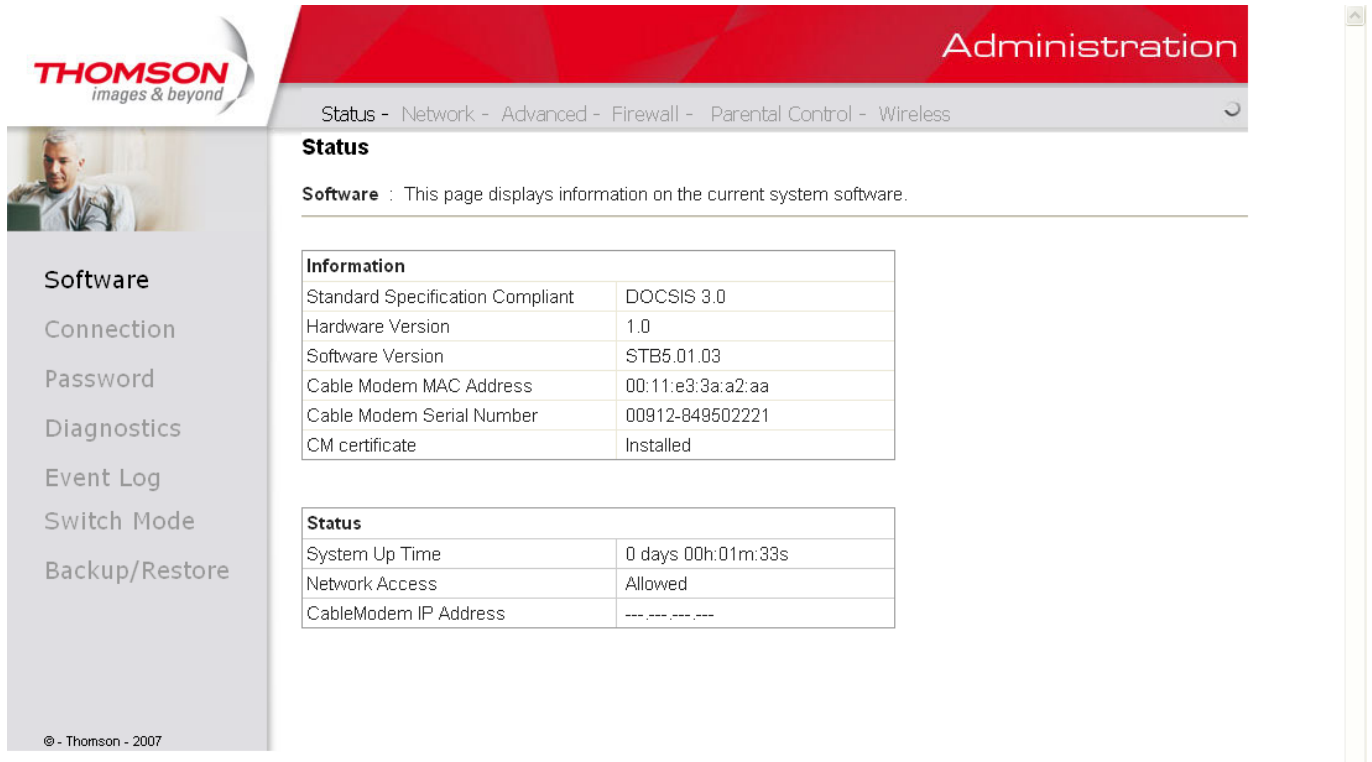

Fig. 5

- **Main Menu:** the hyperlinks on the top of the page.
- **Title:** the sidebar on the left side of the page indicates the title of this management interface, e.g., Software in this example
- **Main Window:** the current workspace of the web management, containing configuration or status information

For easy navigation, the pages are organized in groups, with group names main menu, individual page names within each group are provided in the sidebar. To navigate to a page, click the group hyperlink at the top, then the page title on the sidebar.

Your cable company may not support the reporting of some items of information listed on your gateway's internal web pages. In such cases, the information field appears blank. This is normal.

# Chapter 2: WEB Configuration

## Status

### 1. Software

The information section shows the hardware and software information about your gateway.

The status section of this page shows how long your gateway has operated since last time being powered up, and some key information the Cable Modem received during the initialization process with your cable company. If Network Access shows “Allowed,” then your cable company has configured your gateway to have Internet connectivity. If not, you may not have Internet access, and should contact your cable company to resolve this.

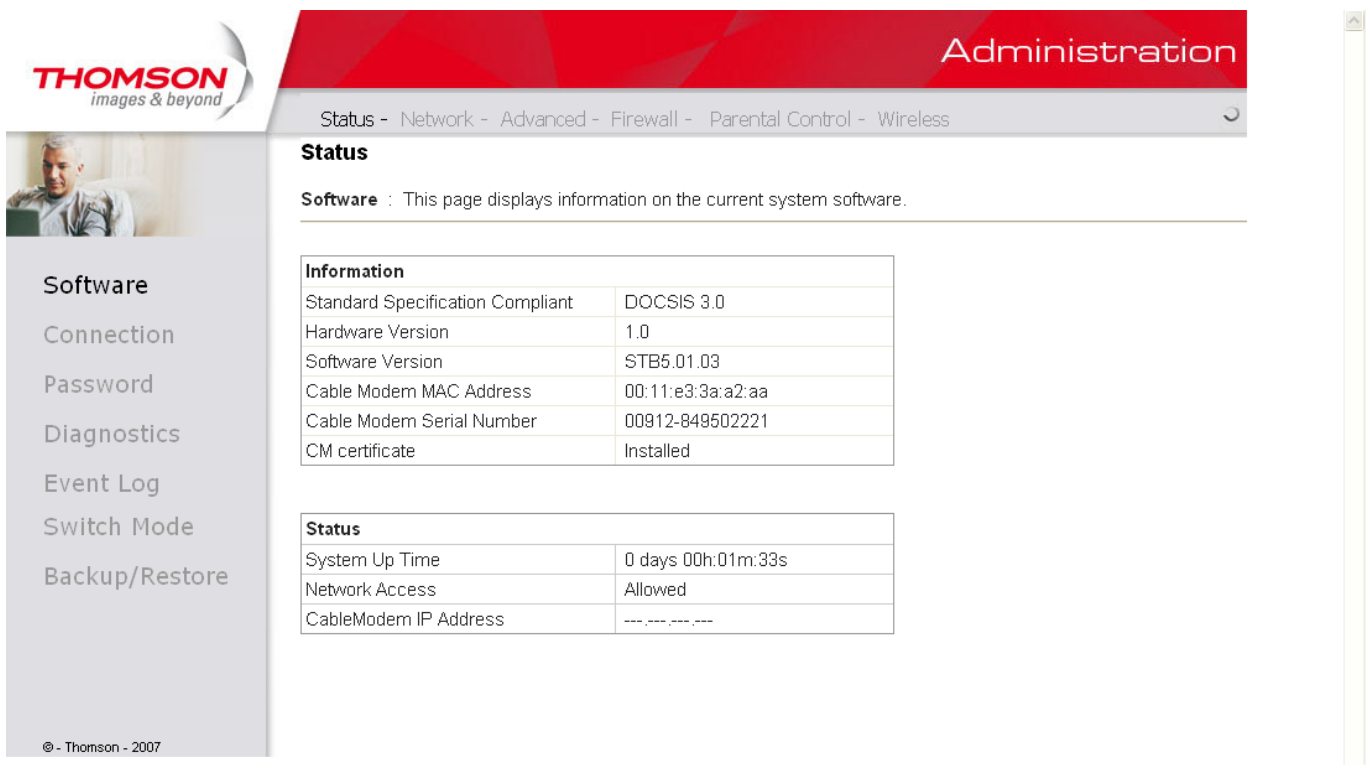

The screenshot shows the Thomson gateway Administration page. The top navigation bar is red with the word "Administration" in white. Below it is a breadcrumb trail: "Status - Network - Advanced - Firewall - Parental Control - Wireless". The main content area is titled "Status" and contains a "Software" section with the text: "This page displays information on the current system software." Below this are two tables. The first table, titled "Information", lists various system details. The second table, titled "Status", shows operational metrics.

Information	
Standard Specification Compliant	DOCSIS 3.0
Hardware Version	1.0
Software Version	STB5.01.03
Cable Modem MAC Address	00:11:e3:3a:a2:aa
Cable Modem Serial Number	00912-849502221
CM certificate	Installed

Status	
System Up Time	0 days 00h:01m:33s
Network Access	Allowed
CableModem IP Address	---.---.---.---

Fig. 6

# Chapter 2: WEB Configuration

## 2. Connection

This page reports current connection status containing startup procedures, downstream and upstream status, CM online information, and so on. The information can be useful to your cable company's support technician if you're having problems.

The screenshot shows the Thomson Administration web interface. The top navigation bar includes 'Status - Network - Advanced - Firewall - Parental Control - Wireless'. The left sidebar contains menu items: Software, Connection, Password, Diagnostics, Event Log, Switch Mode, and Backup/Restore. The main content area is titled 'Status' and contains a 'Connection' section with a descriptive text and two tables: 'Startup Procedure' and 'Downstream Channels'. Below these is an 'Upstream Channels' table.

**THOMSON**  
images & beyond

Administration

Status - Network - Advanced - Firewall - Parental Control - Wireless

**Status**

**Connection** : This page displays information on the status of the cable modem's HFC and IP network connectivity.

Startup Procedure		
Procedure	Status	Comment
Acquire Downstream Channel	692500000 Hz	In Progress
Connectivity State	In Progress	Not Synchronized
Boot State	In Progress	Unknown
Configuration File	In Progress	
Security	Disabled	Disabled

Downstream Channels							
Channel	Lock Status	Modulation	Channel ID	Symbol rate	Frequency	Power	SNR
1	Not Locked	QAM64	0	5056941	692500000 Hz	-51.4 dBmV	27.5 dB
2	Not Locked	Unknown	0	Unknown		0.0 dBmV	0.0 dB
3	Not Locked	Unknown	0	Unknown		0.0 dBmV	0.0 dB
4	Not Locked	Unknown	0	Unknown		0.0 dBmV	0.0 dB
5	Not Locked	Unknown	0	Unknown		0.0 dBmV	0.0 dB
6	Not Locked	Unknown	0	Unknown		0.0 dBmV	0.0 dB
7	Not Locked	Unknown	0	Unknown		0.0 dBmV	0.0 dB
8	Not Locked	Unknown	0	Unknown		0.0 dBmV	0.0 dB

Upstream Channels						
Channel	Lock Status	Modulation	Channel ID	Symbol Rate	Frequency	Power
1	Not Locked	Unknown	0	0 Ksym/sec		0.0 dBmV
2	Not Locked	Unknown	0	0 Ksym/sec		0.0 dBmV
3	Not Locked	Unknown	0	0 Ksym/sec		0.0 dBmV
4	Not Locked	Unknown	0	0 Ksym/sec		0.0 dBmV

© - Thomson - 2007

Fig. 7

# Chapter 2: WEB Configuration

## 3. Password

This page is used to change the password that enables you to access the gateway web pages next time. The default User ID is “ ”(*EMPTY*), and the password is “*admin*”. The password can be a maximum of 8 characters and is case sensitive. In addition, this page can be used to restore the gateway to its original factory settings. Use this with caution, as all the settings you have made will be lost. To perform this reset, set **Restore Factory Defaults** to **Yes** and click **Apply**. This has the same effect as a factory reset using the rear panel reset switch, where you hold on the switch for 15 seconds, then release it.

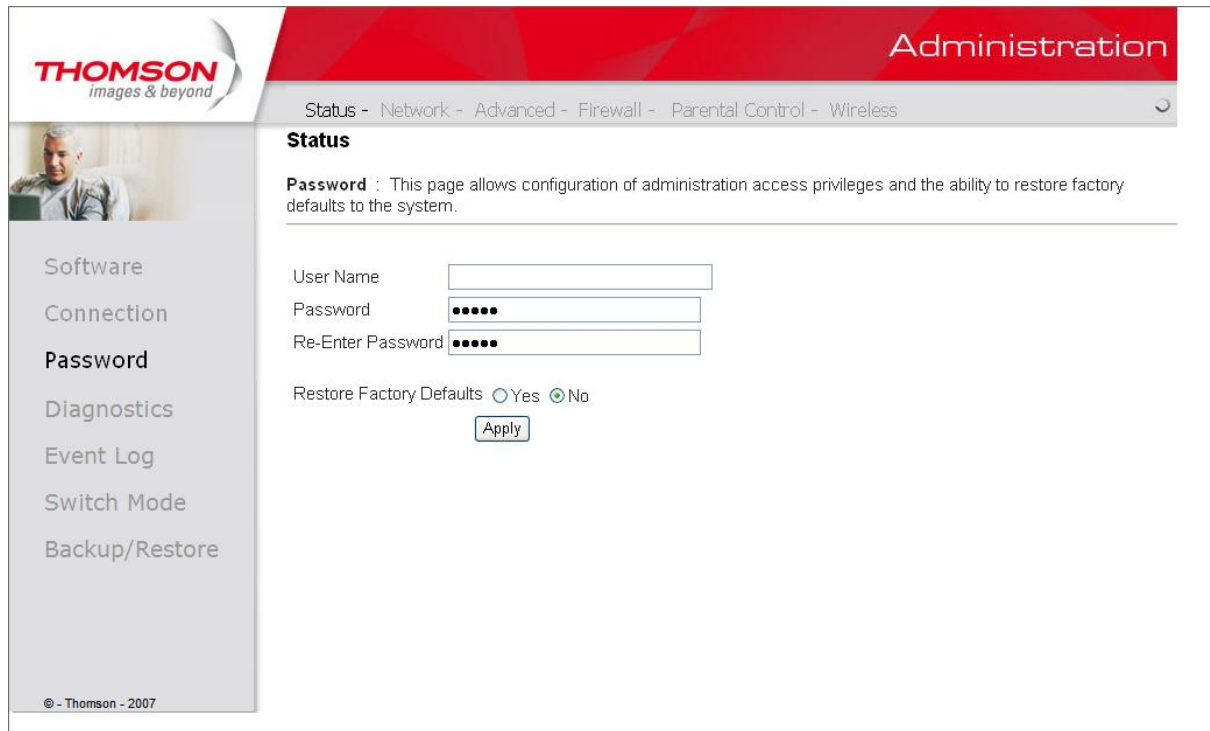

Fig. 8

# Chapter 2: WEB Configuration

## 4. Diagnostics

This page offers basic diagnostic tools for you to utilize when connectivity problems occur. When you ping an Internet device, you send a packet to its TCP/IP stack, and it sends one back to yours. To use the ping Test, enter the information needed and press **Start Test**; the Result will be displayed in the lower part of the window. Press **Abort Test** to stop, and **Clear Results** to clear the result contents.

*Note: Firewalls may cause pings to fail but still provide you TCP/IP access to selected devices behind them. Keep this in mind when pinging a device that may be behind a firewall. Ping is most useful to verify connectivity with PCs have no firewall, such as the PCs on your LAN side.*

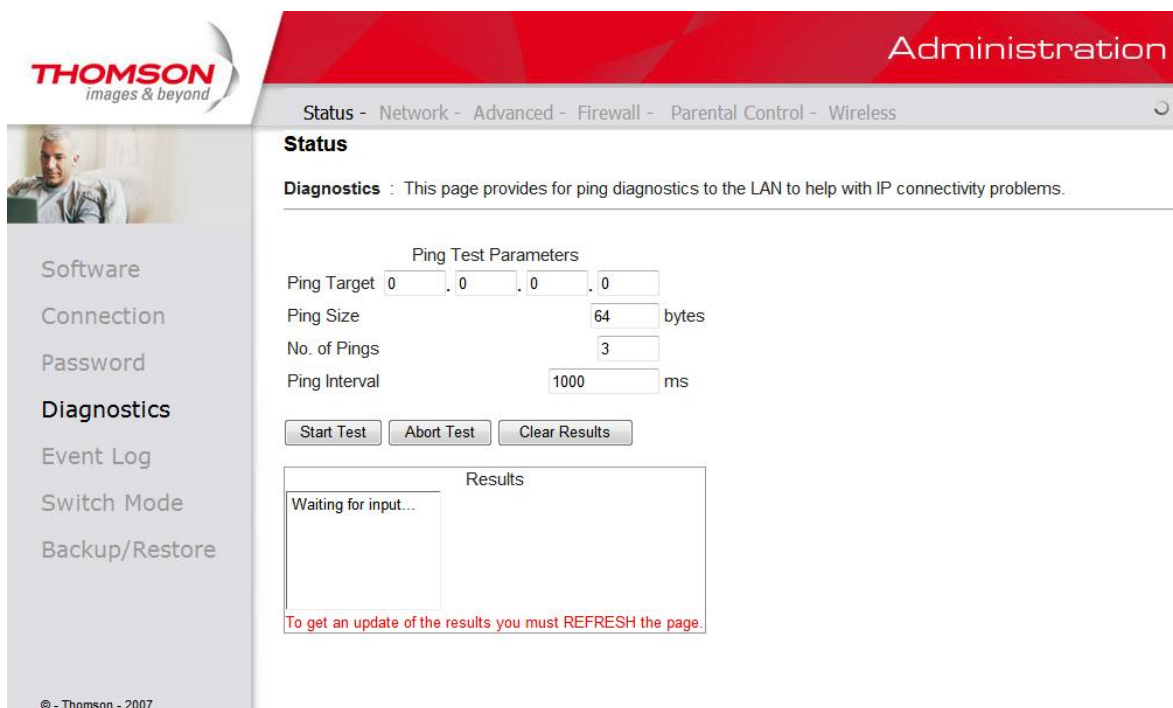

Fig. 9



# Chapter 2: WEB Configuration

## 5. Event Log

This page displays the contents of the SNMP event log. Press “Clear Log” button to clear the logs.

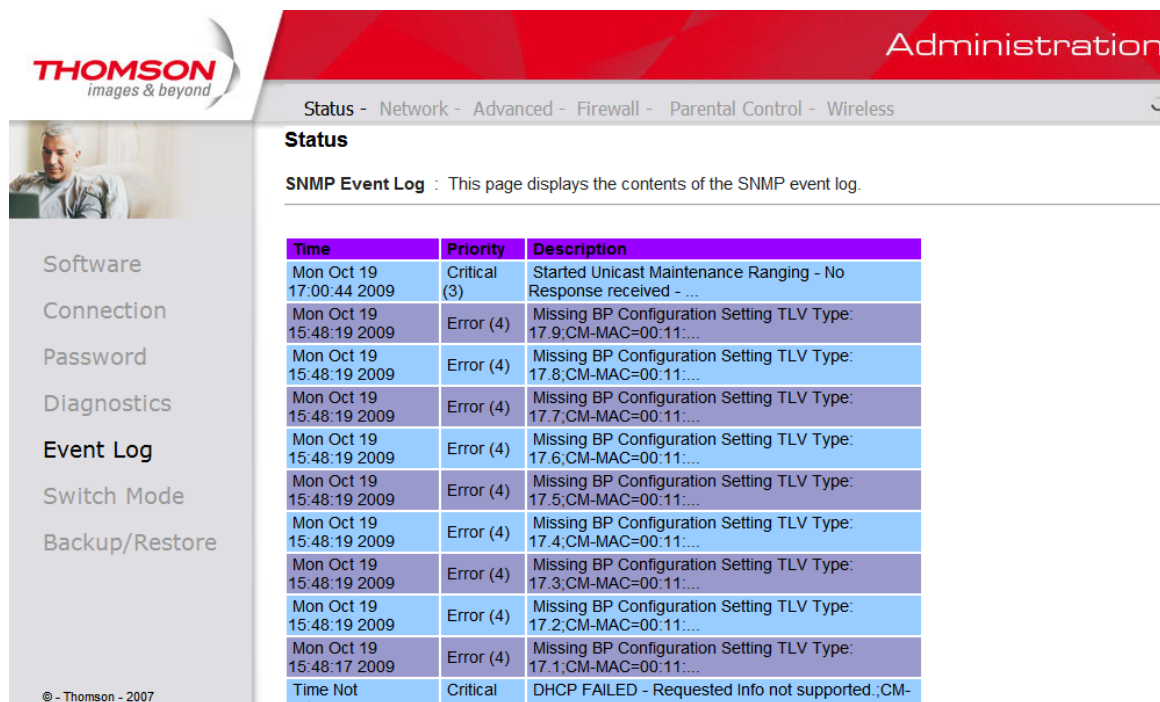

Fig. 10

## 6. Switch Mode

This page displays switch mode..

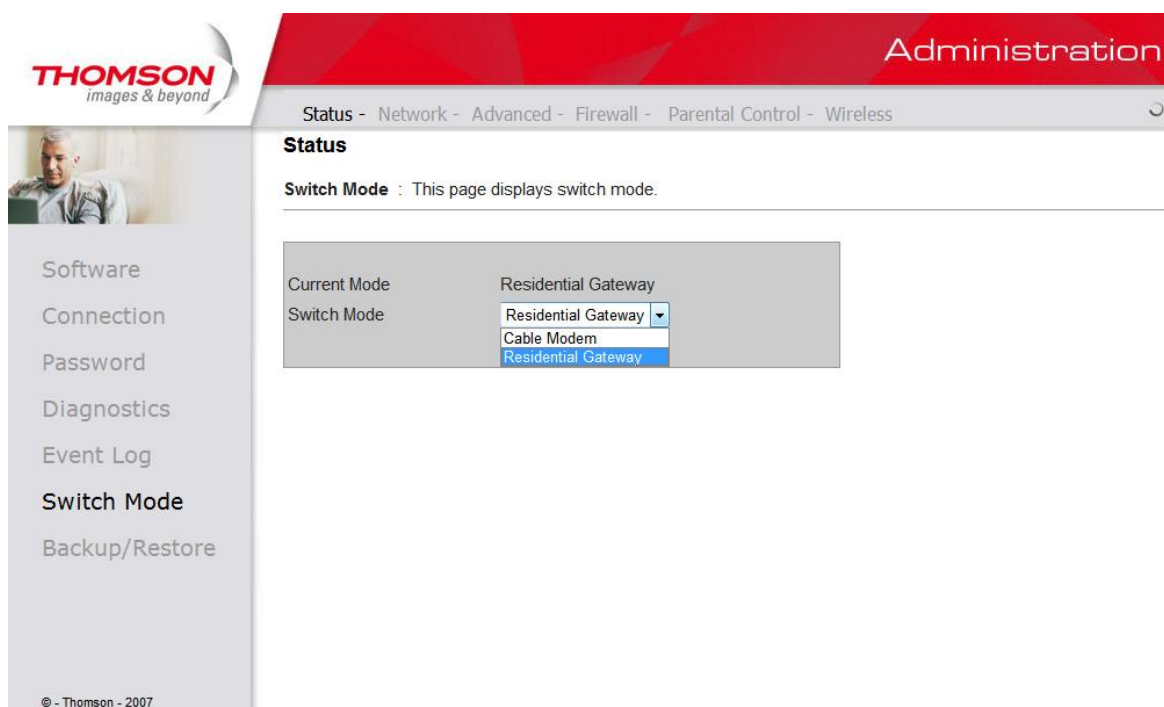

Fig. 11

# Chapter 2: WEB Configuration

## 7. Backup/Restore

This page allows you to save your current settings locally on your PC, or restore settings previously saved.

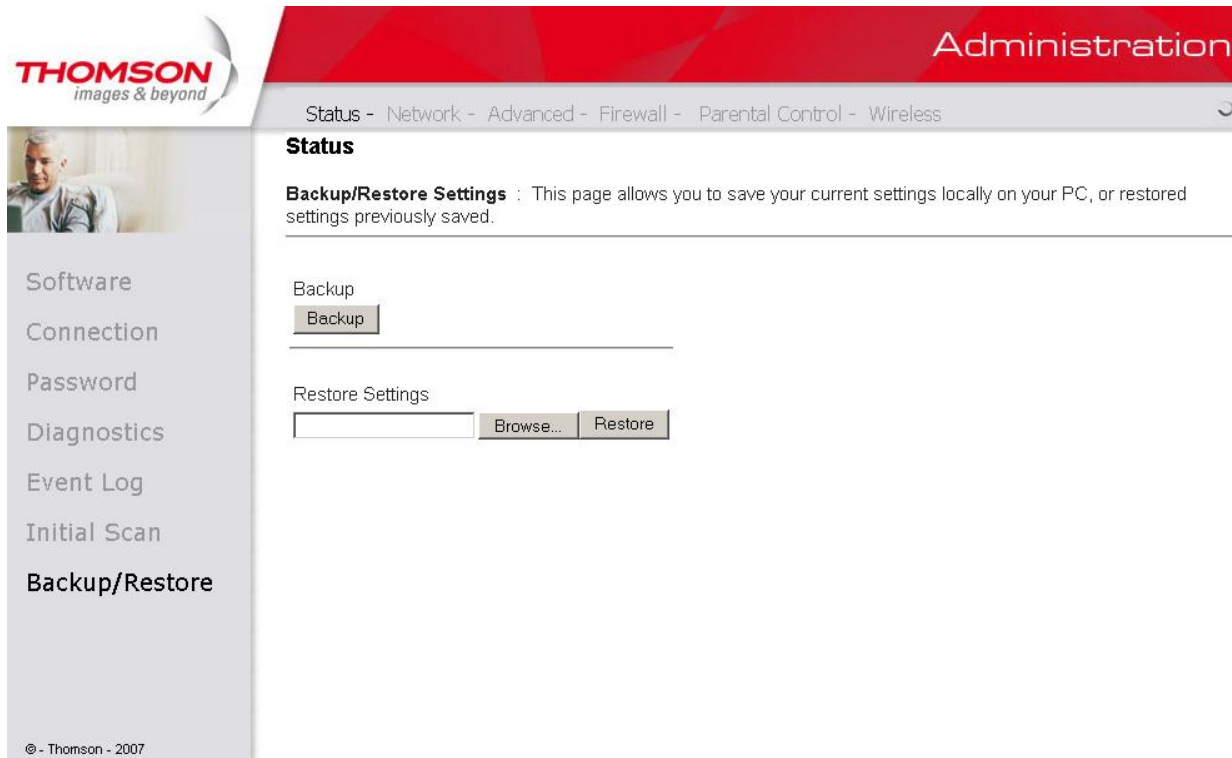

Fig. 12

# Chapter 2: WEB Configuration

## Network

### 1. LAN

You can activate the DHCP server function for the LAN on this page.

With this function activated, your cable company's DHCP server provides one IP address for your gateway, and your gateway's DHCP server provides IP addresses, starting at the address you set in IP Address on the LAN page, to your PCs. A DHCP server leases an IP address with an expiration time.

To change the lowest IP address that your gateway will issue to your PCs, enter it into the **IP Address** box and then click **Apply**.

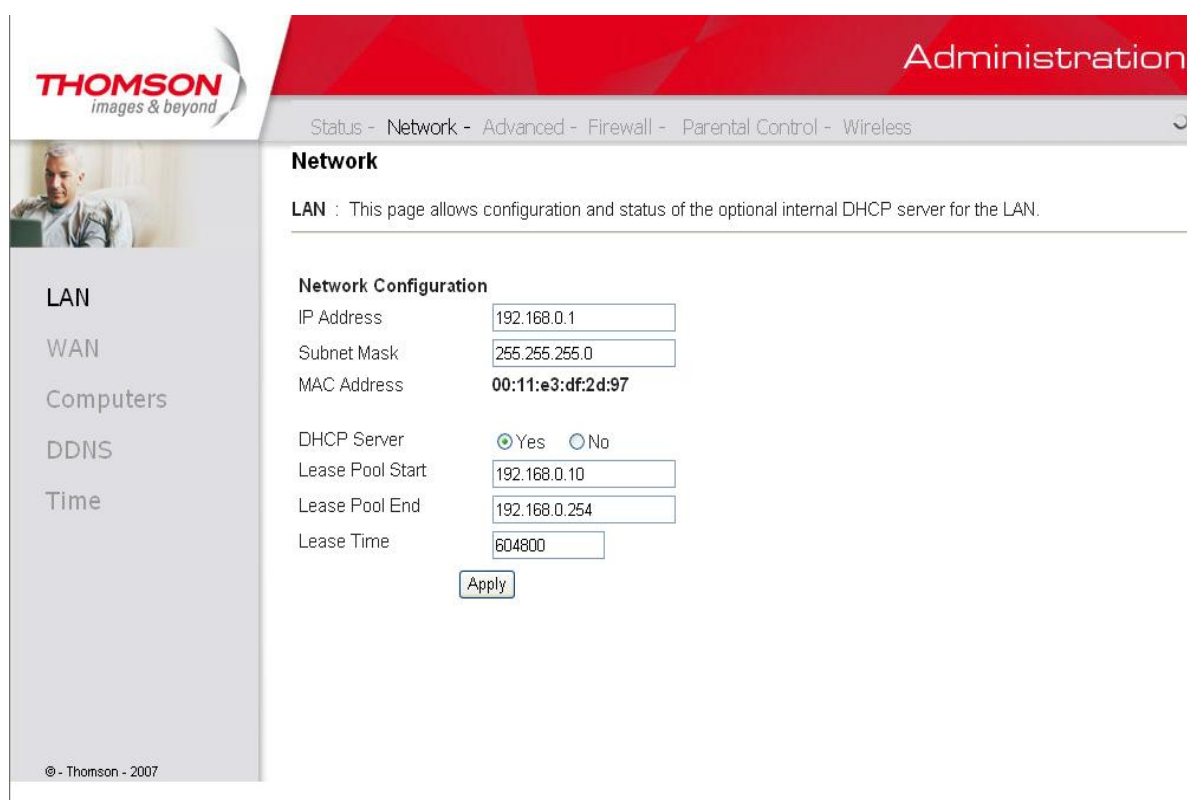

Fig. 13

# Chapter 2: WEB Configuration

## 2. WAN

You can configure the optional internal DHCP server for the WAN on this page. Select different WAN Connection Type will lead to different contents. Take the WAN connection type-DHCP for example, you can release and renew the WAN lease by pressing the buttons.

You can enter a spoofed MAC address that causes your gateway networking stack to use that MAC address when communicating instead of the usual WAN MAC address, e.g., if the MAC address is `00:11:e3:df:66:95`, this spoofed MAC address could be `00:11:e3:df:66:97` or any desired MAC address.

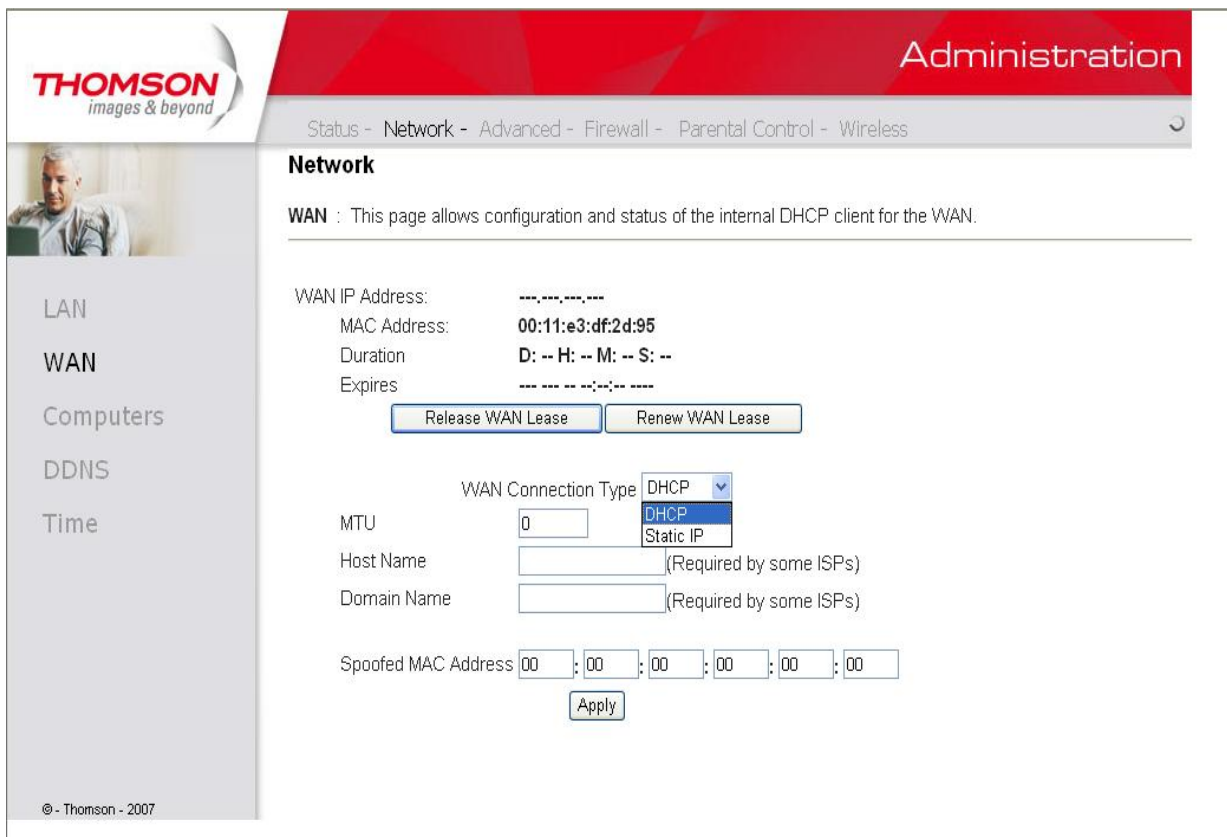

Fig. 14

# Chapter 2: WEB Configuration

## 3. Computers

This page displays the status of the DHCP clients and current system time. You can cancel an IP address lease by selecting it in the DHCP Client Lease Info list and then clicking the **Force Available** button. If you do so, you may have to perform a DHCP Renew on that PC, so that it can obtain a new lease.

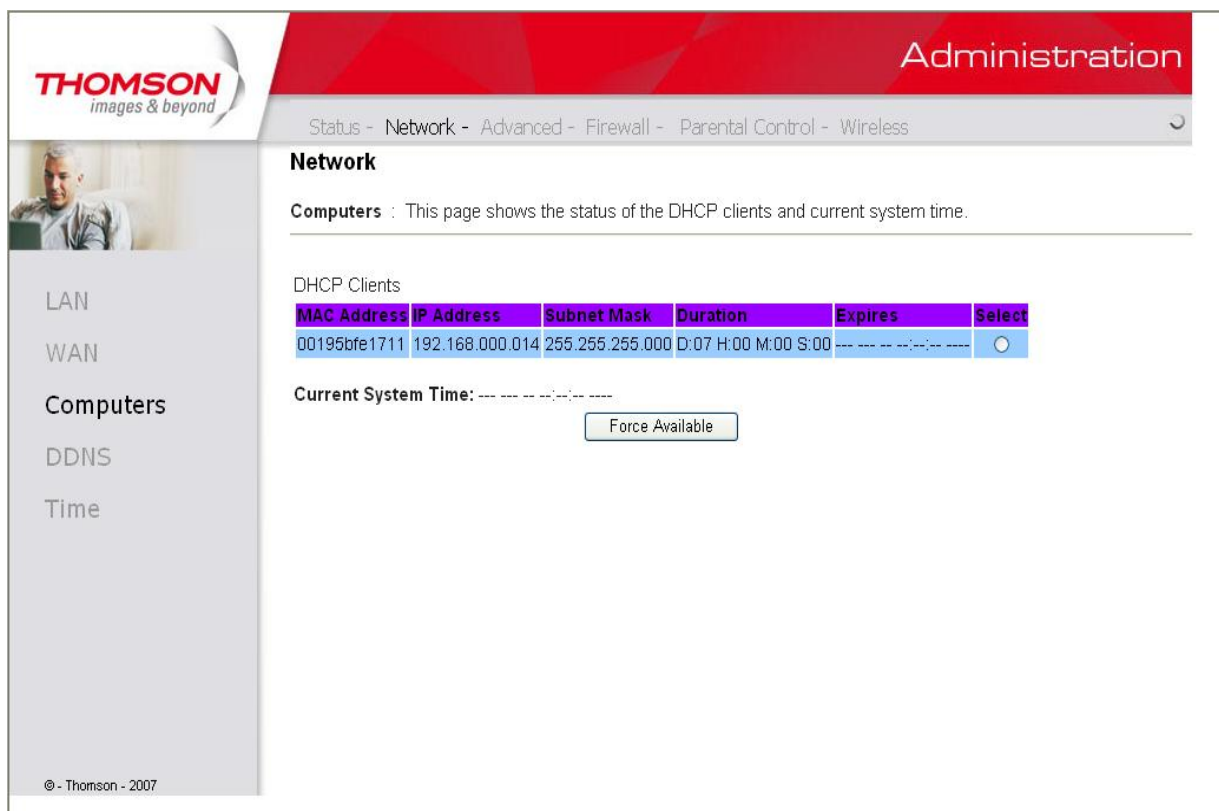

Fig. 15

# Chapter 2: WEB Configuration

## 4. DDNS

This page allows setup of Dynamic DNS service.

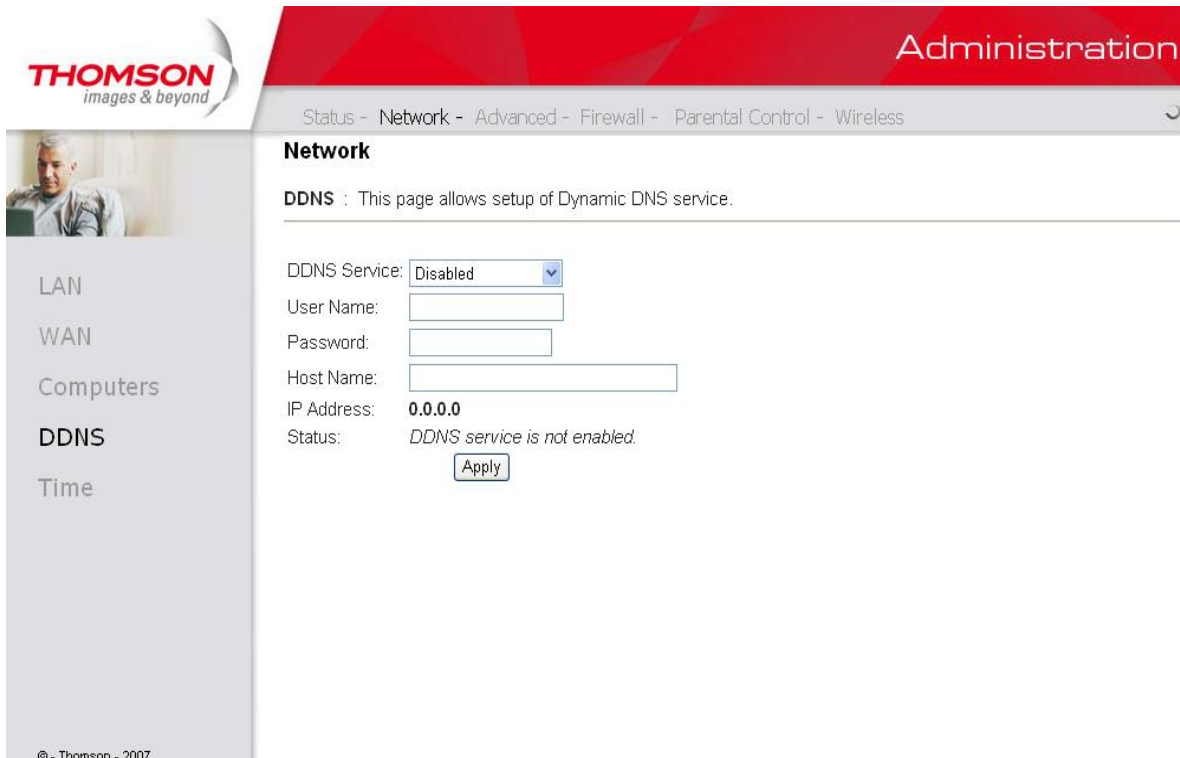

Fig. 16

- **DDNS Service-** Choose Enabled ( [www.DynDNS.org](http://www.DynDNS.org) ) to enable the basic setting. Choose Disabled to close the basic setting.
- **Username-** The username that you registered with your DDNS provider.
- **Password-** The password that you registered with your DDNS provider
- **Host Name-** The domain name or host name that is registered with your DDNS provider
- **Status-** It shows the DDNS service status whether it is enabled or disabled.

Click Apply to save the changes

# Chapter 2: WEB Configuration

## 5. Time

This page allows configuration and display of the system time obtained from network servers via Simple Network Time Protocol. The system has to be reset for any changes to take effect.

The screenshot shows the Thomson Administration web interface. The top navigation bar is red with the Thomson logo on the left and the word "Administration" on the right. Below the navigation bar is a breadcrumb trail: "Status - Network - Advanced - Firewall - Parental Control - Wireless". The main content area is titled "Network" and contains a "Time" section. The "Time" section includes a description: "Time : This page allows configuration and display of the system time obtained from network servers via Simple Network Time Protocol. The system has to be reset for any changes to take effect." Below the description are several configuration options: "Enable SNTP" with radio buttons for "Yes" and "No" (where "No" is selected); "Current Time" showing "Thu Jan 01 03:07:27 1970"; "System Start Time" showing "Thu Jan 01 00:00:00 1970"; "Time Server 1" with a text input field containing "clock.via.net"; "Time Server 2" with a text input field containing "ntp.nasa.gov"; "Time Server 3" with a text input field containing "tick.ucla.edu"; and "Timezone Offset" with "Hours" and "Minutes" dropdown menus, both set to "0". At the bottom of the configuration section are "Apply" and "Reset Values" buttons. On the left side of the interface is a vertical navigation menu with options: "LAN", "WAN", "Computers", "DDNS", and "Time" (which is highlighted). The footer of the page contains the copyright notice "© - Thomson - 2007".

## Advanced

### 1. Options

This page allows you to enable/disable some features of the Wireless Gateway.

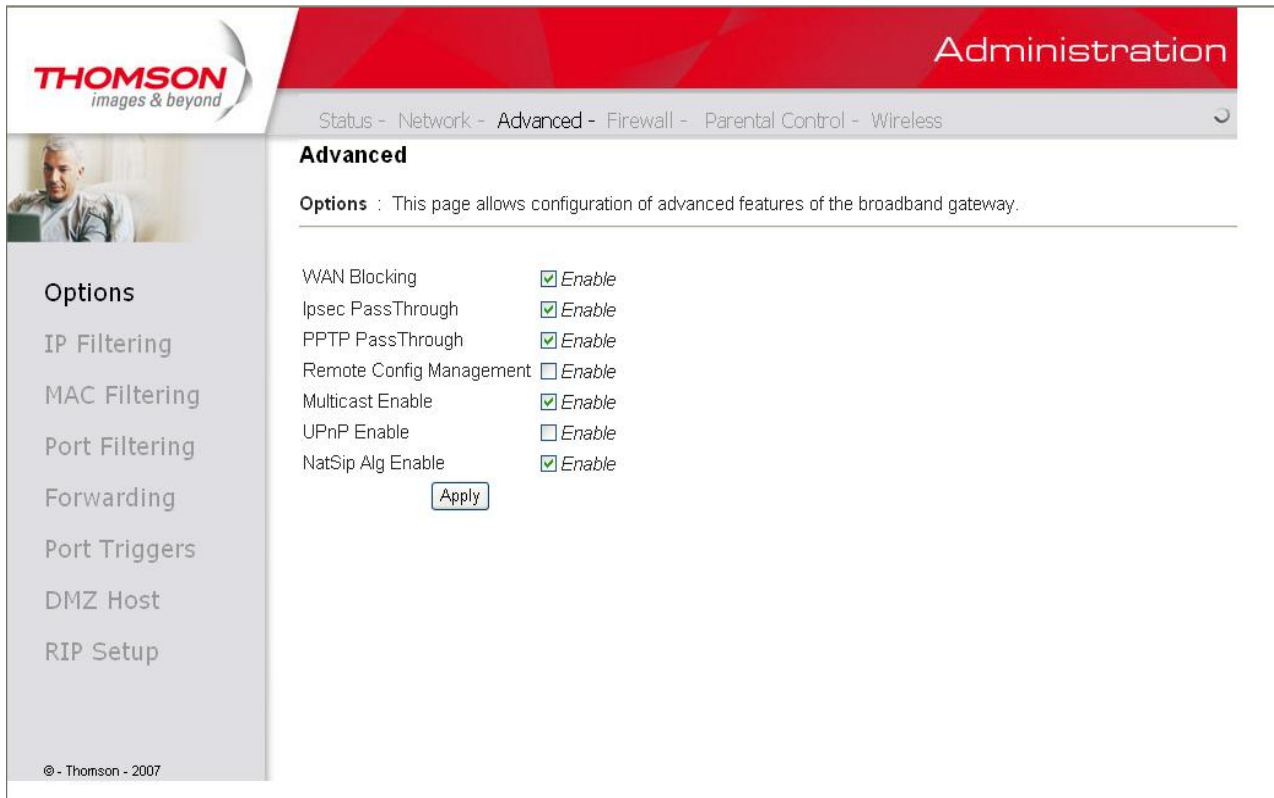

Fig. 17

- **WAN Blocking** prevents others on the WAN side from being able to ping your gateway. With WAN Blocking enabled, your gateway will not respond to pings it receives, effectively “hiding” your gateway.
- **Ipssec PassThrough** enables IpSec type packets to pass WAN ⇔ LAN. IpSec (IP Security) is a security mechanism used in Virtual Private Networks (VPNs).
- **PPTP PassThrough** enables PPTP type packets to pass WAN ⇔ LAN. PPTP (Point to Point Tunneling Protocol) is another mechanism sometimes used in VPNs.
- **Remote Config Management** makes the configuration web pages in your gateway accessible from the WAN side. Note that page access is limited to only those who know the gateway access password. When accessing your gateway from a remote location, you must use HTTP port 8080 and the WAN IP address of the gateway. For example, if the WAN IP address is 157.254.5.7, you would navigate to <http://157.254.5.7:8080> to reach your gateway.
- **Multicast Enable** enables multicast traffic to pass WAN ⇔ LAN. You may need to enable this to see some types of broadcast streaming and content on the Internet.



# Chapter 2: WEB Configuration

- **UPnP** Universal Plug and Play (UPnP) helps devices, such as Internet appliances and computers, access the network and connect to other devices as needed. UPnP devices can automatically discover the services from other registered UPnP devices on the network.
- **NatSip Alg Enable** feature enabled by default. While ALG could help in solving NAT related problems in client LAN side. An ALG understands the protocol used by the specific applications that it supports and does a protocol packet-inspection of SIP traffic through it. A NAT router with inbuilt SIP ALG can re-write information within the SIP messages (SIP headers and SDP body) making possible signaling and audio traffic between LAN client and outside SIP endpoint.

## 2. IP Filtering

This page enables you to enter the IP address ranges of PCs on your LAN that you don't want to have outbound access to the WAN. These PCs can still communicate with each other on your LAN, but packets they originate to WAN addresses are blocked by the gateway.

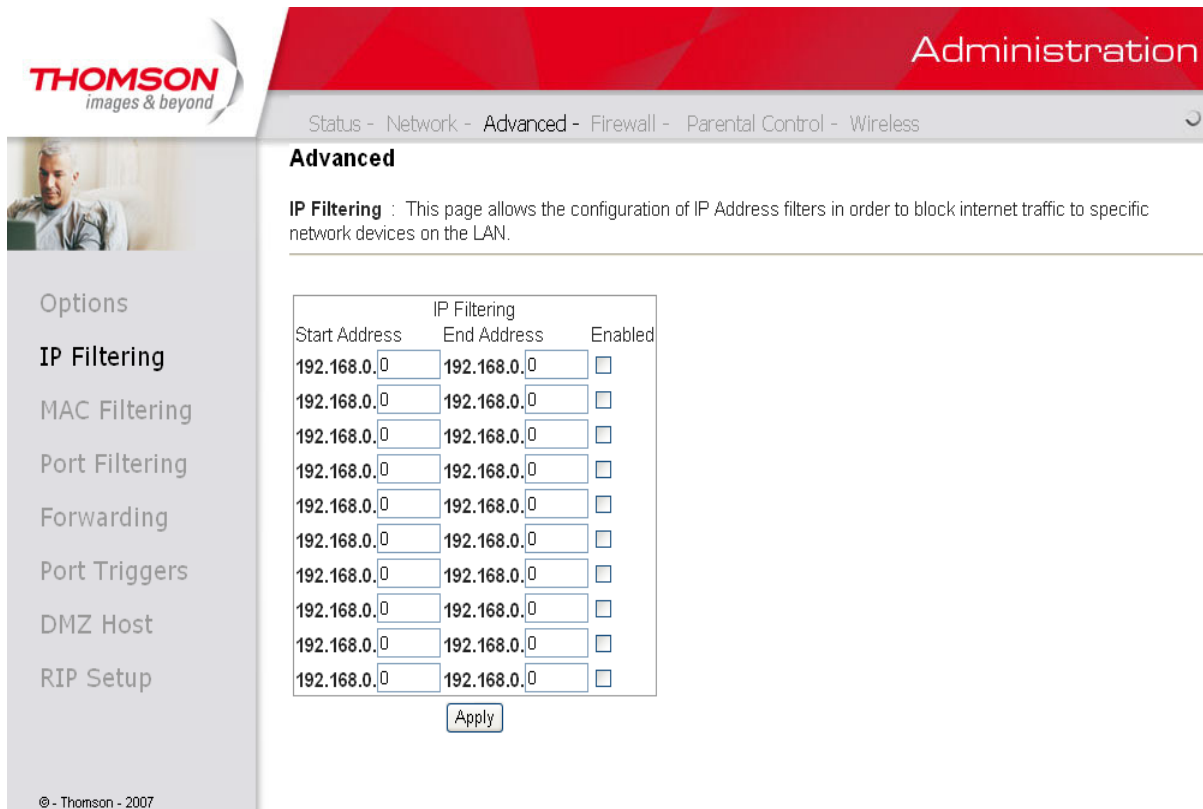

Fig. 18

# Chapter 2: WEB Configuration

## 3. MAC Filtering

This page enables you to enter the MAC address of specific PCs on your LAN that you wish to NOT have outbound access to the WAN. As with IP filtering, these PCs can still communicate with each other through the gateway, but packets they send to WAN addresses are blocked.

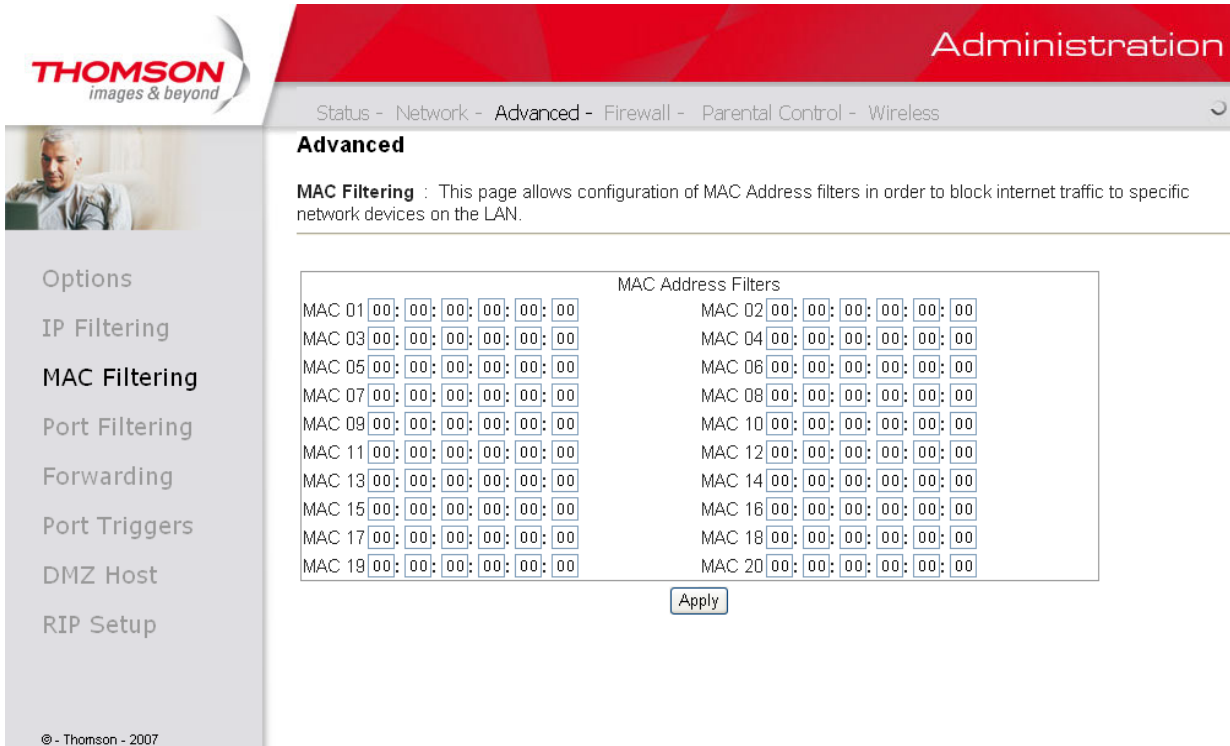

Fig. 19

# Chapter 2: WEB Configuration

## 4. Port Filtering

This page allows you to enter ranges of destination ports (applications) that you don't want your LAN PCs to send packets to. Any packets your LAN PCs send to these destination ports will be blocked. For example, you could block access to worldwide web browsing (http = port 80) but still allow email service (SMTP port 25 and POP-3 port 110). To enable port filtering, set Start Port and End Port for each range, and click Apply. To block only one port, set both Start and End ports the same.

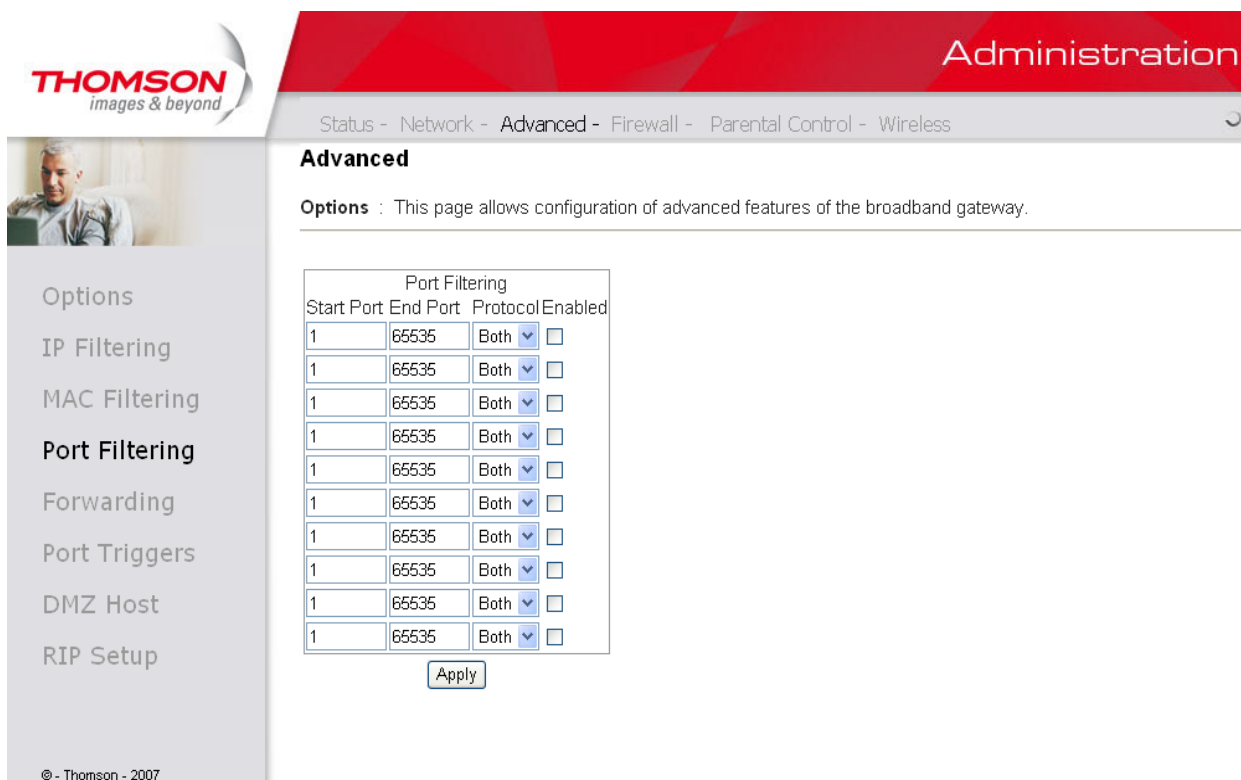

Fig. 20

# Chapter 2: WEB Configuration

## 5. Forwarding

For LAN ↔ WAN communications, the gateway normally only allows you to originate an IP connection with a PC on the WAN; it will ignore attempts of the WAN PC to originate a connection onto your PC. This protects you from malicious attacks from outsiders. However, sometimes you may wish for anyone outside to be able to originate a connection to a particular PC on your LAN if the destination port (application) matches one you specify.

This page allows you to specify up to 10 such rules. For example, to specify that outsiders should have access to an FTP server you have running at 192.168.0.5, create a rule with that address and Start Port =20 and End Port =21 (FTP port ranges) and Protocol = TCP (FTP runs over TCP and the other transport protocol, UDP), and click Apply. This will cause inbound packets that match to be forwarded to that PC rather than blocked. As these connections are not tracked, no entry is made for them in the Connection Table. The same IP address can be entered multiple times with different ports.

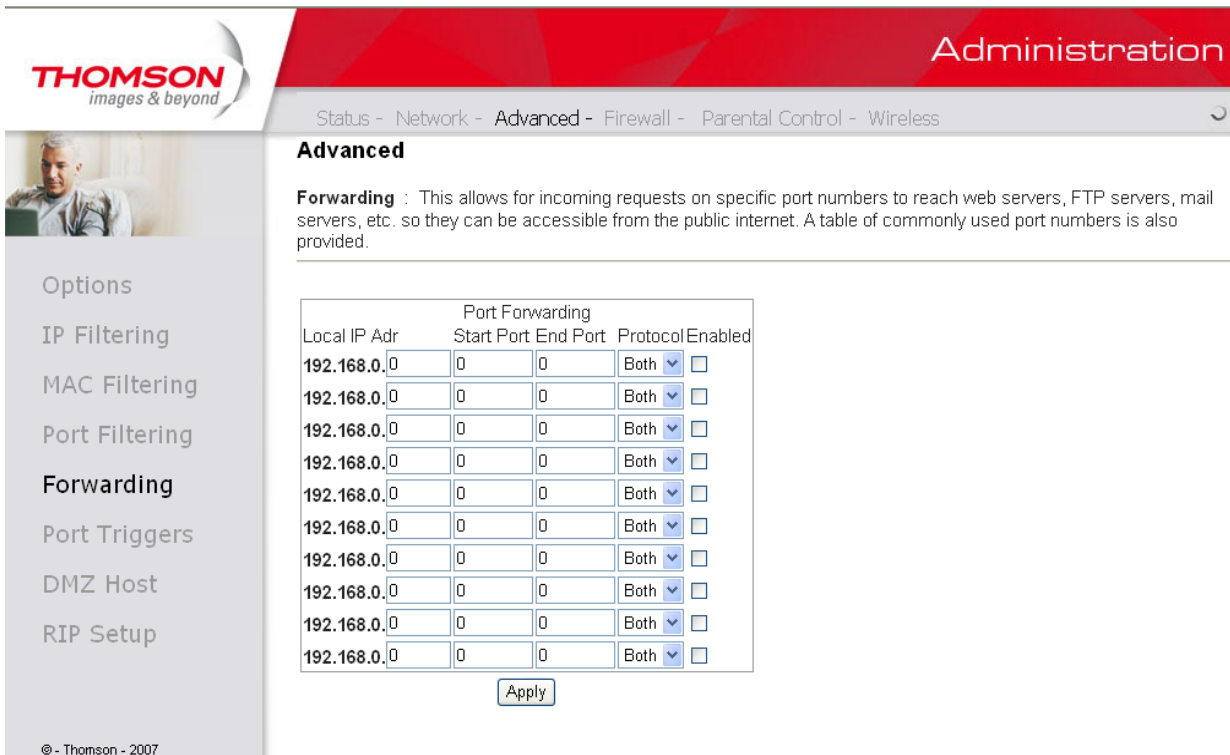

Fig. 21

# Chapter 2: WEB Configuration

## 6. Port Triggers

Some Internet activities, such as interactive gaming, require that a PC on the WAN side of your gateway be able to originate connections during the game with your game playing PC on the LAN side. You could use the Advanced-Forwarding web page to construct a forwarding rule during the game, and then remove it afterwards (to restore full protection to your LAN PC) to facilitate this. Port triggering is an elegant mechanism that does this work for you, each time you play the game.

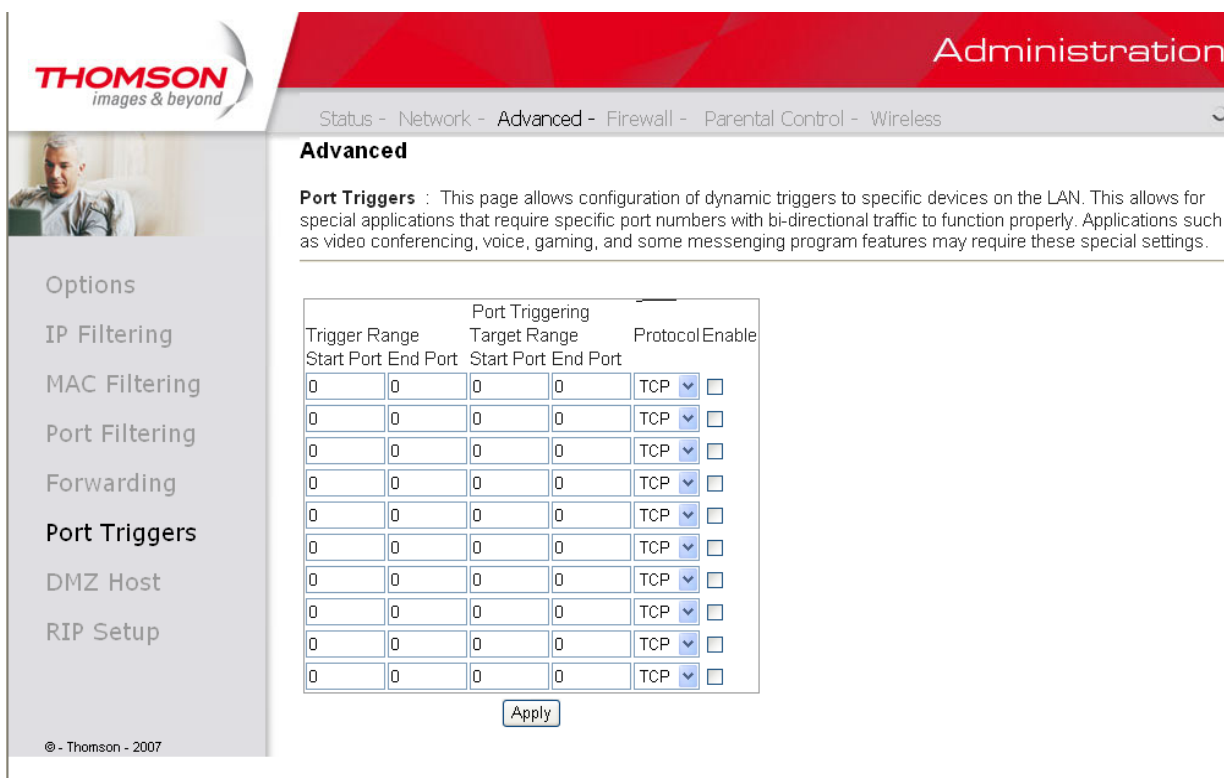

Fig. 22

Port Triggering works as follows. Imagine you want to play a particular game with PCs somewhere on the Internet. You make one time effort to set up a Port Trigger for that game, by entering into **Trigger Range** the range of destination ports your game will be sending to, and entering into **Target Range** the range of destination ports the other player (on the WAN side) will be sending to (ports your PC's game receives on). Application programs like games publish this information in user manuals. Later, each time you play the game, the gateway automatically creates the forwarding rule necessary. This rule is valid until 10 minutes after it sees game activity stop. After 10 minutes, the rule becomes inactive until the next matched outgoing traffic arrives.

For example, suppose you specify Trigger Range from 6660 to 6670 and Target Range from 113 to 113. An outbound packet arrives at the gateway with your game-playing PC source IP address 192.168.0.10, destination port 666 over TCP/IP. This destination port is within the Trigger destined for port 113 to your game-playing PC at 192.168.0.10.

You can specify up to 10 port ranges on which to trigger.

# Chapter 2: WEB Configuration

## 7. DMZ Host

Use this page to designate one PC on your LAN that should be left accessible to all PCs from the WAN side, for all ports. For example, if you put an HTTP server on this machine, anyone will be able to access that HTTP server by using your gateway IP address as the destination. A setting of “0” indicates NO DMZ PC. “Host” is another Internet term for a PC connected to the Internet.

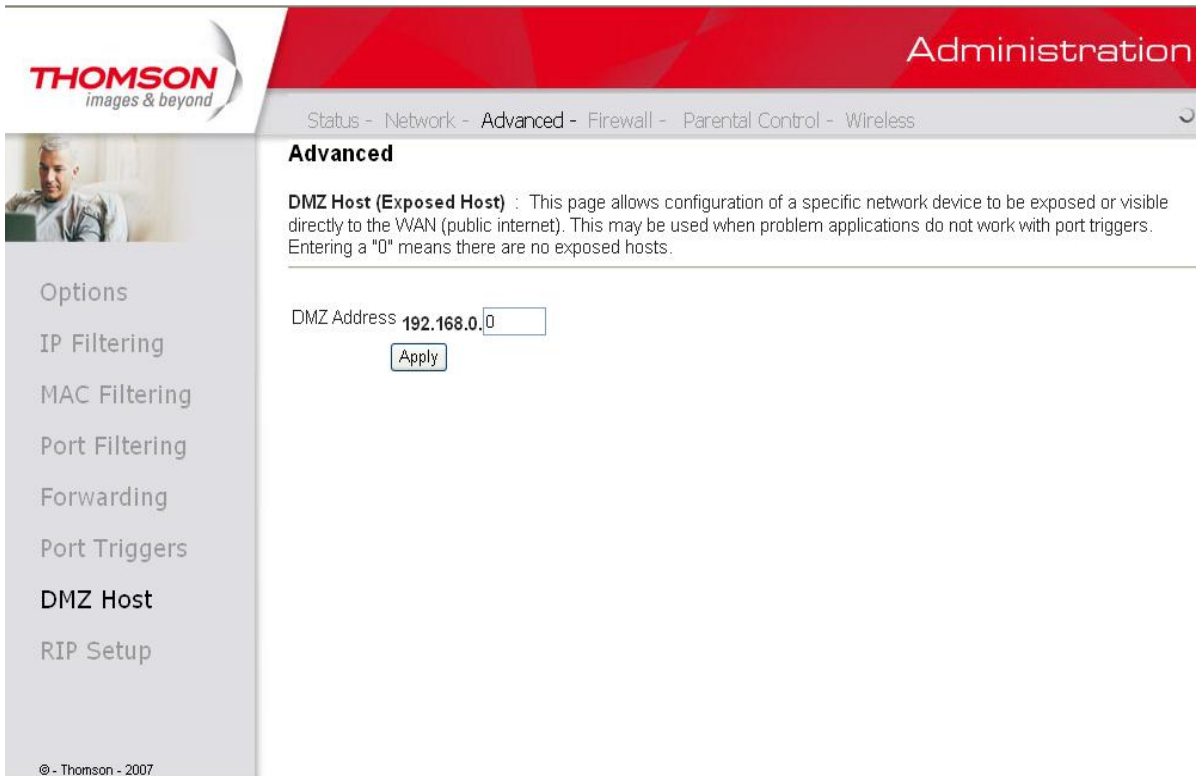

Fig. 23

# Chapter 2: WEB Configuration

## 8. RIP (Routing Information Protocol) Setup

This feature enables the gateway to be used in small business situations where more than one LAN (local area network) is installed. The RIP protocol provides the gateway a means to “advertise” available IP routes to these LANs to your cable operator, so packets can be routed properly in this situation.

Your cable operator will advise you during installation if any setting changes are required here.

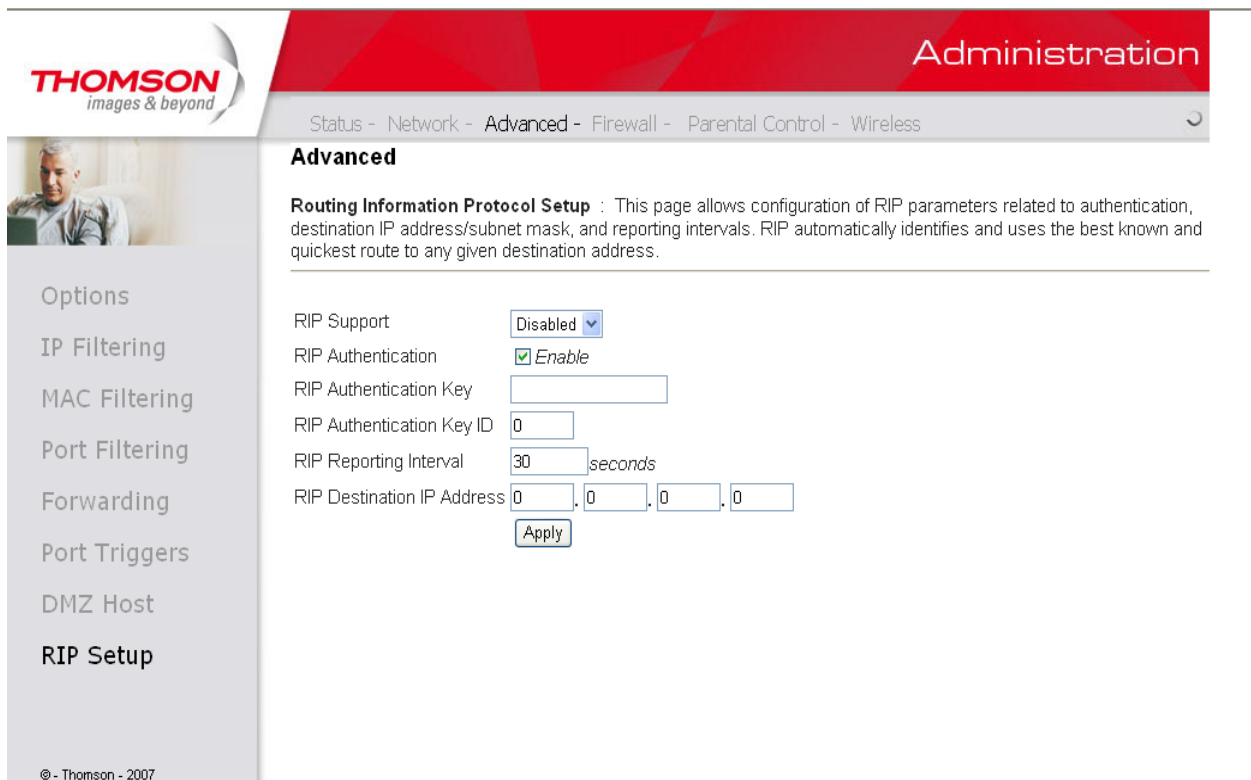

Fig. 24

## Firewall

### 1. Web Filtering

These pages allow you to enable, disable, and configure a variety of firewall features associated with web browsing, which uses the HTTP protocol and transports HTML web pages. On these pages, you designate the gateway packet types you want to have forwarded or blocked. You can activate settings by checking them and clicking Apply.

The web-related filtering features you can activate from the Web Content Filter page include Filter Proxy, Filter Cookies, Filter Java Applets, Filter ActiveX, Filter Popup Windows, and Firewall Protection.

If you want the gateway to exclude your selected filters to certain computers on your LAN, enter their MAC addresses in the Trusted Computers area of this page.

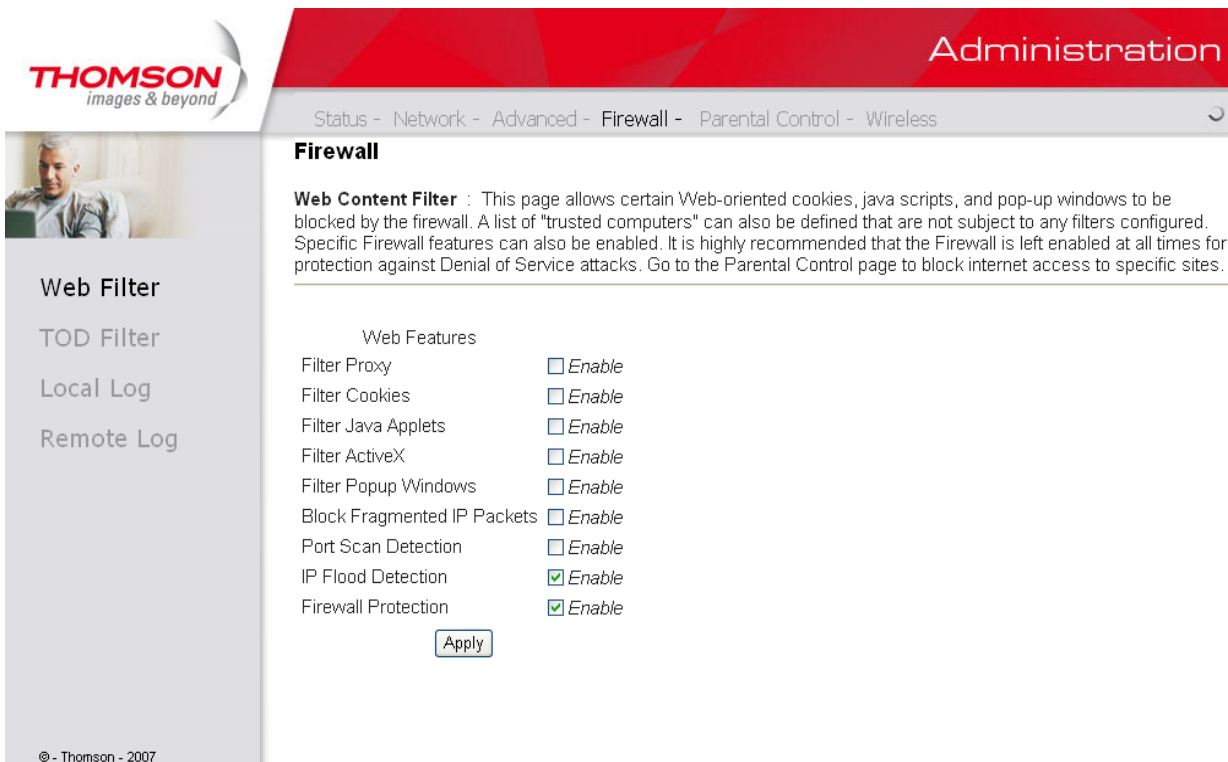

Fig. 25



# Chapter 2: WEB Configuration

## 2. TOD Filtering

Use this page to set rules that will block specific LAN side PCs from accessing the Internet, but only at specific days and times. Specify a PC by its hardware MAC address, and then use the tools to specify blocking time. Finally, click the Apply button to save your settings.

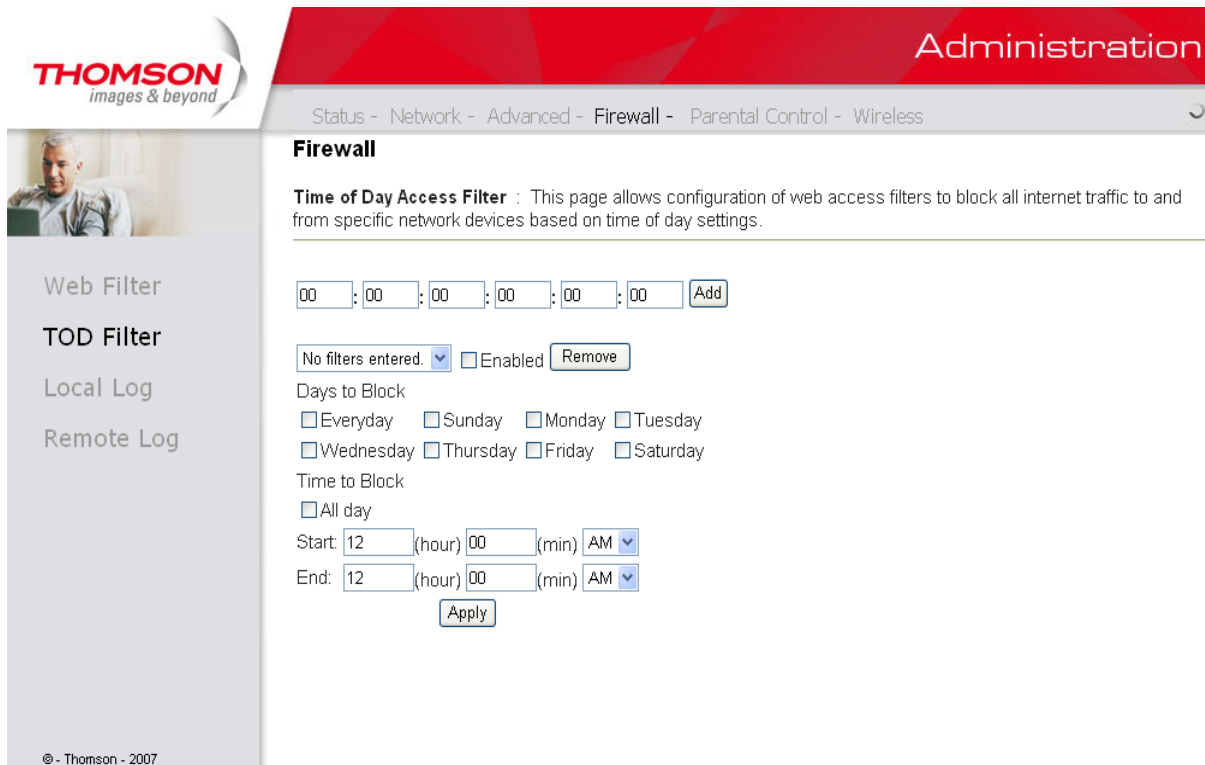

Fig. 26

# Chapter 2: WEB Configuration

## 3. Local Log and Remote Log

The gateway builds a log of firewall blocking actions that Firewall has taken. Using the Local Log page lets you specify an email address to which you want the gateway to email this log. You must also tell the gateway your outgoing (i.e. SMTP) email server's name, so it can direct the email to it. Enable Email Alerts has the gateway forward email notices when Firewall protection events occur. Click **E-mail Log** to immediately send the email log. Click **Clear Log** to clear the table of entries for a fresh start.

The log of these events is also visible on the screen. For each blocking event type that has taken place since the table was last cleared, the table shows Description, Count, Last Occurrence, Target, and Source.

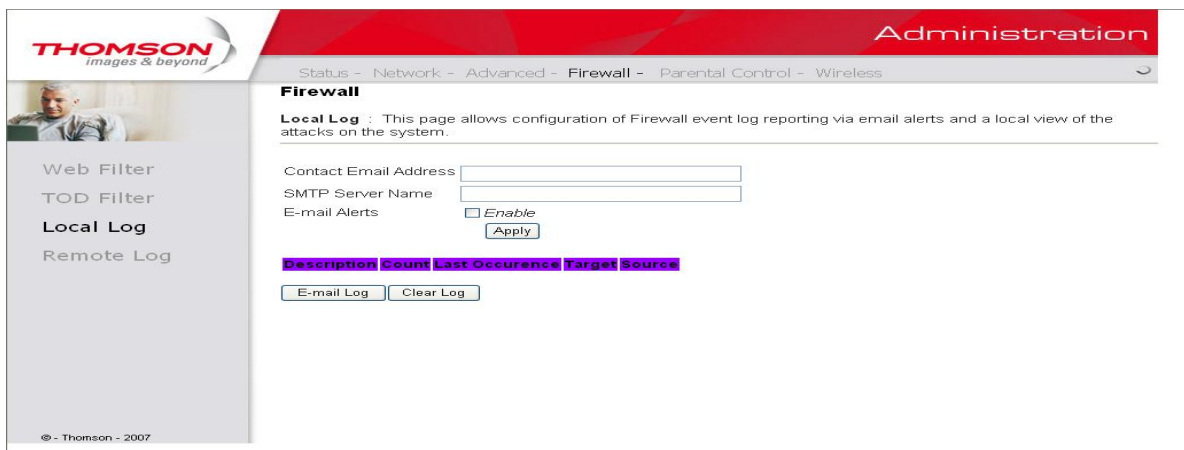

Fig. 27

The Remote Log page allows you to specify the IP address where a SysLog server is located and select different types of firewall events that may occur. Then, each time such an event occurs, notification is automatically sent to this log server.

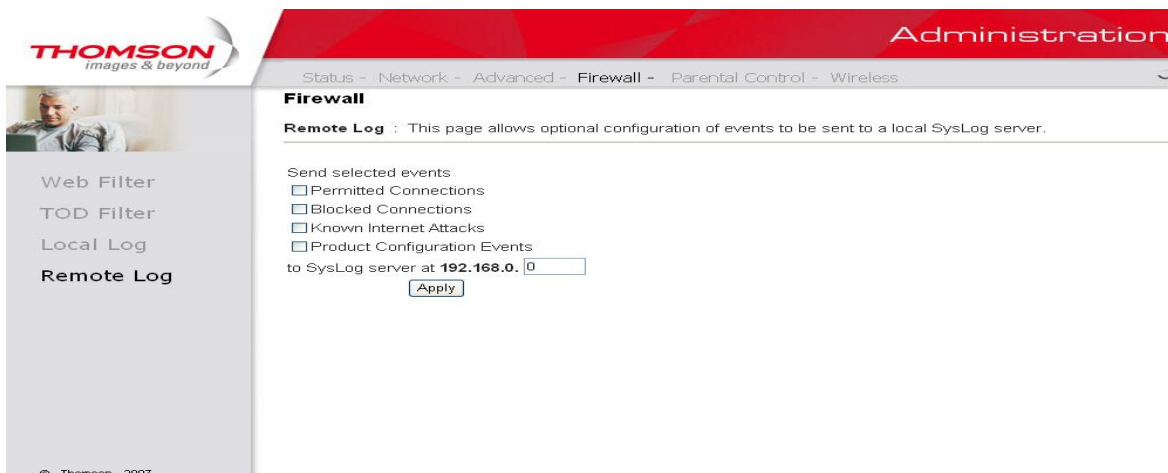

Fig. 28

# Chapter 2: WEB Configuration

## Parental Control

### 1. Basic

This page allows you to enable, disable, and configure a variety of firewall features associated with web browsing, which uses the HTTP protocol and transports HTML web pages. On these pages, you designate the gateway packet types you want to have forwarded or blocked. You can activate settings by checking them and clicking Apply.

Here are some of your choices on the Parental Control page:

- ◆ Activate **Keyword Blocking** and specify some keywords in the Keyword List to cause blocking of web pages on the WAN side with the specified keyword in the content.
- ◆ Activate **Domain Blocking** and specify some Domain Names (e.g. disney.com) in the Domain List.

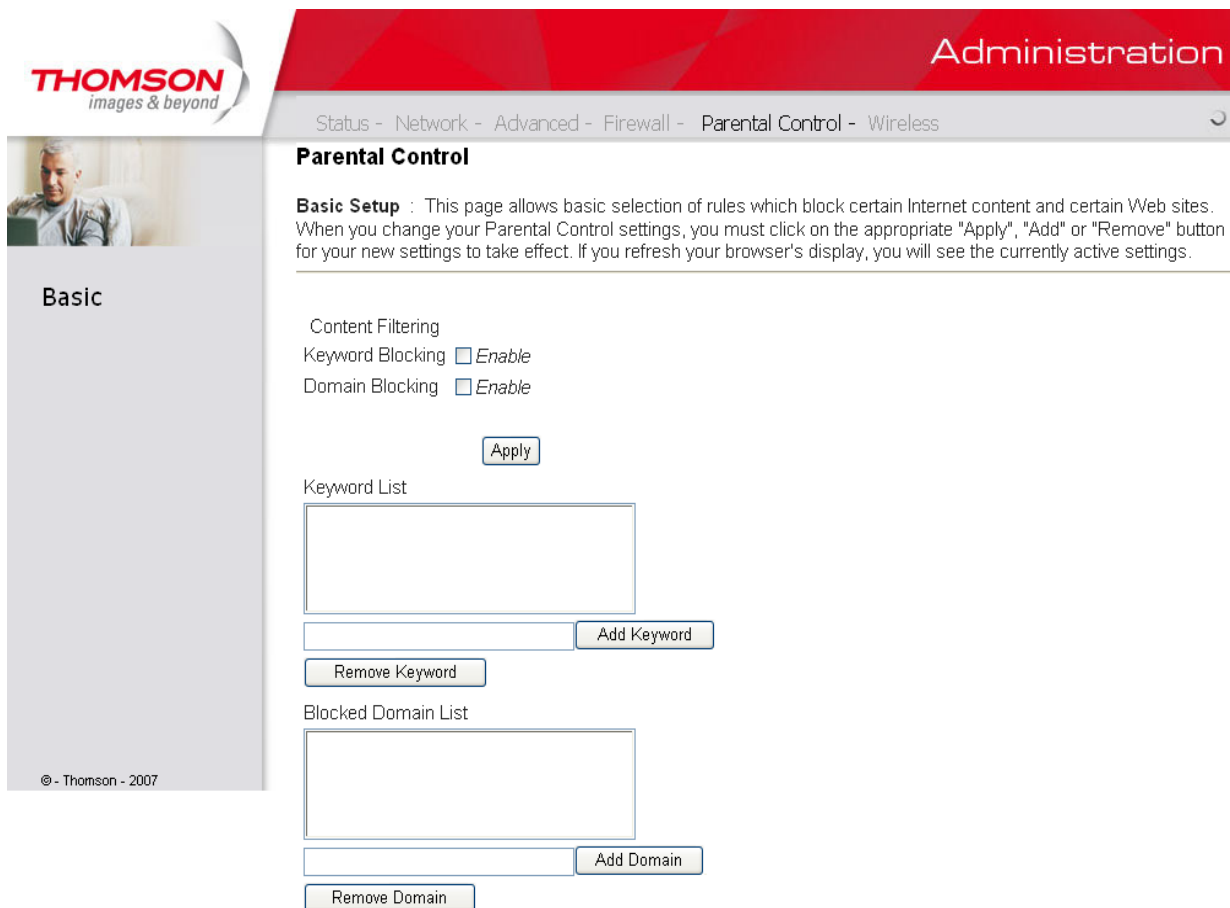

Fig. 29

# Chapter 2: WEB Configuration

## Wireless

---

*Important: Changes to the wireless web pages should be made from a PC that is hard wired to the gateway, i.e. via Ethernet.*

The Wireless web pages group enables a variety of settings that can provide secure and reliable wireless communications for even the most demanding tech-savvy user.

The DCW775 gateway offers a choice of 802.1x, WPA and WPA-PSK authentication of your PCs to the gateway, 64 and 128 bit WEP encryption of communication between the gateway and your PCs to guaranty security, and an Access Control List function that enables you to restrict wireless access to only your specific PCs.

The wireless function will probably work in your home as shipped from the factory. In addition, the factory default wireless channel setting may not provide optimum changes are recommended from the factory defaults, to secure your wireless communications and provide optimum performance.

### **Performance**

Because your wireless communication travels through the air, the factory default wireless channel setting may not provide optimum performance in your home if you or your neighbors have other interfering 2.4GHz devices such as cordless phones. If your wireless PC is experiencing very sluggish or dramatically slower communication compared with the speed you achieve on your PC that is wired to the gateway, try changing the channel number. See the 802.11b/g Radio Web Page discussion below for details.

### **Authentication**

Authentication enables you to restrict your gateway from communicating with any remote wireless PCs that aren't yours. The following minimum authentication-related changes to factory defaults are recommended. See the 802.11b/g Radio and Access Control Web Page discussions below for details.

Network Name (SSID) – Set a unique name you choose

Network Type – Set to Open

Access Control List – Enter your wireless PCs' MAC addresses

### **Security**

Security secures or scrambles messages traveling through the air between your wireless PCs and the gateway, so they can't be observed by others. The following minimum security setting changes to factory defaults are recommended. See the 802.11b/g Primary Network Web Page discussion below for details.

Data Encryption – Set to WEP (64-bit)

PassPhrase – Use this feature to generate security keys

# Chapter 2: WEB Configuration

## 1. 802.11/ Radio

To set the basic configuration for the wireless features, please click **Radio** item from the **Wireless** menu.

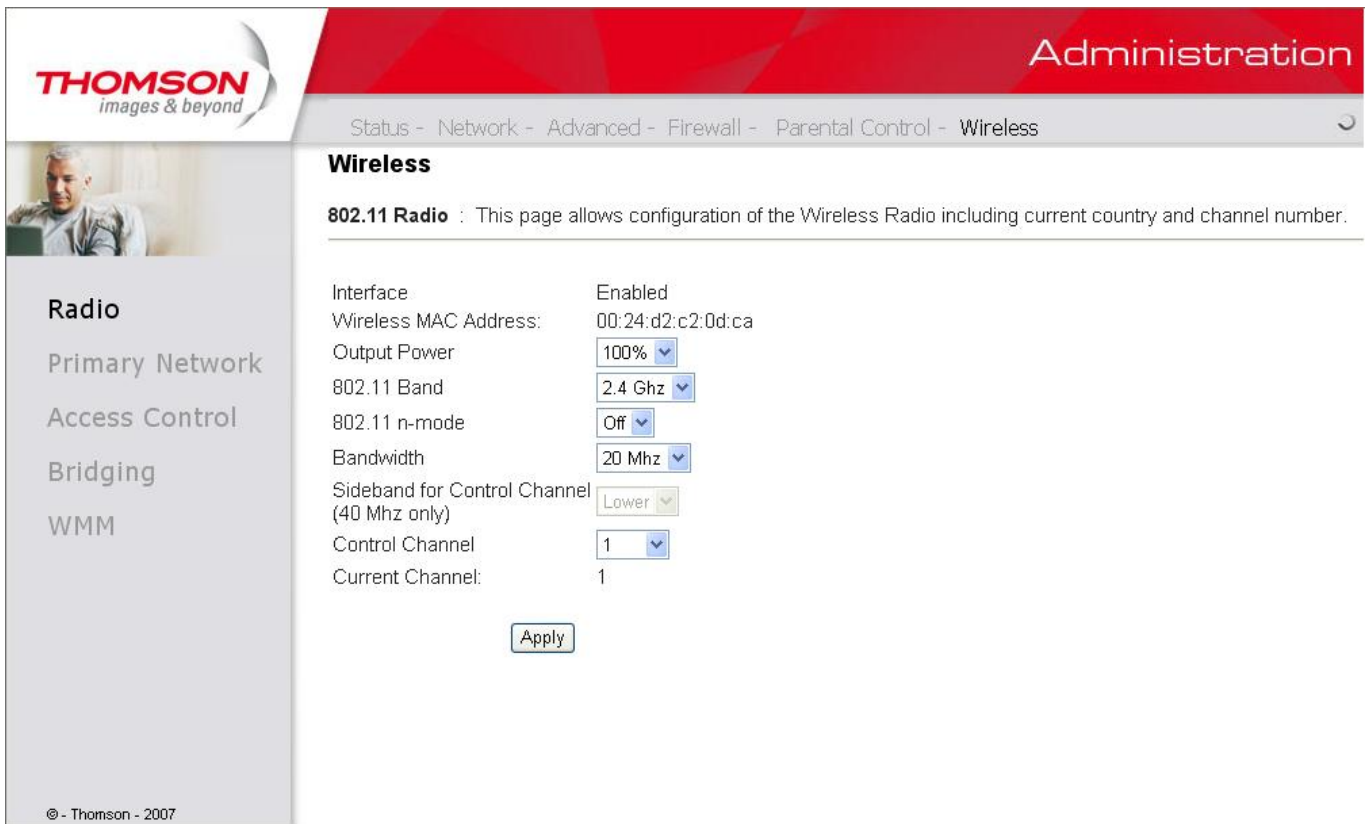

Fig. 30

- **Interface:** Enable by default
- **Wireless MAC Address:** The MAC address for this wireless device will be displayed in this field automatically.
- **802.11 Band:** It can Support 2.4G and 5G.
- **802.11n mode:** It will help you to **Enable** or **Disable** the 11N mode. To enable you need to select **Auto**, to disable you need to select **Off**
- **Bandwidth:** Select wireless channel width 20Mhz is for default value (bandwidth taken by wireless signals of this access point.)
- **Sideband for Control Channel (40Mhz only):** There are “Lower” and “Upper” can be selected if Bandwidth 40Mhz is Enabled.
- **Control Channel:** There are 11 channels that you can choose. Choose the one that is suitable for this device.
- **Current Channel:** The channel that you choose will be displayed in this field.

## Chapter 2: WEB Configuration

Setting	Description	Value List or Range	Default
<b>Network Name (SSID)</b>	Set the Network Name (also known as SSID) of this network.	Network name format is <b>Model name XX(XX=last 2 digits of the CM MAC)</b> <ul style="list-style-type: none"> <li>Default subscriber SSID name is device model number followed by the last octet (2 digits) of the CM MAC address using only uppercase alpha-numeric characters with no punctuation.</li> </ul>	DCW775XX
<b>Network Type</b>	Select Closed to hide the network from active scans. Select Open to reveal the network to active scans.	Open, Closed	Open
<b>Control Channel</b>	Select a particular channel on which to operate.	1-11	1
<b>Interface</b>	Enable by default	Enabled	Enabled

Table1. Basic Settings Definitions

# Chapter 2: WEB Configuration

## 2. 802.11/ Primary Network

This page allows you to configure the Network Authentication. It provides several different modes of wireless security. You will have to enter proper information according to the mode you select.

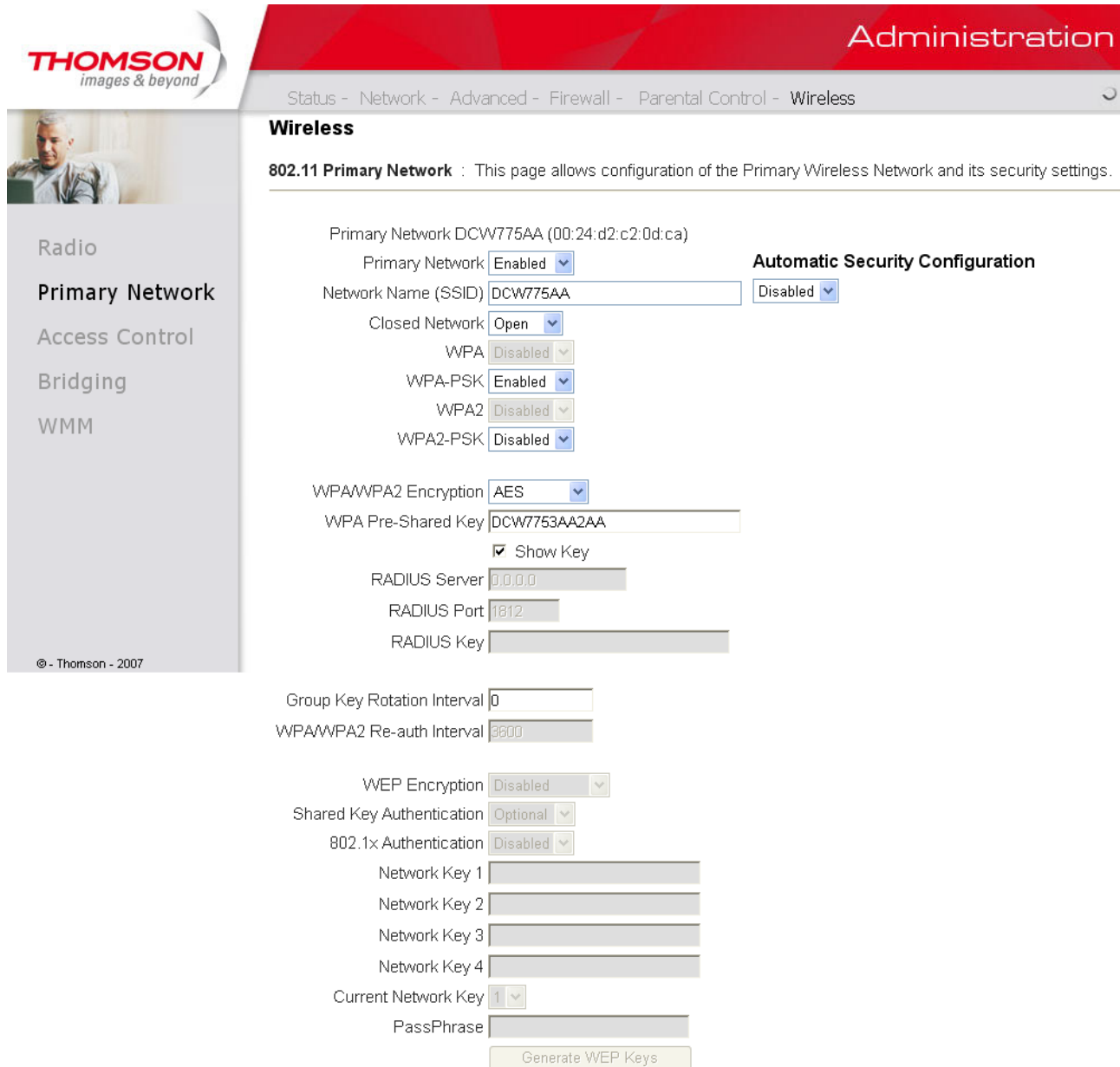

Fig. 31

**Primary Network:** Used to Enable or Disable the whole Primary Network feature.

**Network Name (SSID):** By using this you can change the factory default to a name of your choice up to 32 characters long.

**Closed Network:** This control is used to hide or reveal your network name (SSID) to any remote, wireless equipped PC in the area that may be scanning WiFi channels to find available WiFi networks. The gateway WiFi radio frequently transmits a beacon signal which can contain this network name (SSID). If you set Closed Network to Enable, your SSID is included in that beacon, and is therefore detectable by any nearby wireless equipped PCs in

## Chapter 2: WEB Configuration

the area. The benefit of using Enable is it can speed your WiFi setup on some PCs. If you set Closed Network to Disable, your SSID is not included in the beacon. This hides your network name (SSID), but as a result may require a bit more effort on your part to set up your wireless PCs. And when we Enable the **WPS Config** then the **Closed Network** will be Disabled automatically.

### WPA (Wi-Fi Protected Access)/WPA2:

It must be used in conjunction with an authentication server such as RADIUS to provide centralized access control and management. It can provide stronger encryption and authentication solution than none WPA modes. **WPA2** is the second generation of **WPA** security

### WPA-PSK (WPA-Pre-Shared Key) /WPA2-PSK (WPA2-Pre-Shared Key):

It is useful for small places without authentication servers such as the network at home. It allows the use of manually-entered keys or passwords and is designed to be easily set up for home users.

### WEP Encryption:

You can choose **64-bit** or **128-bit** according to your needs. If you choose **Disabled**, the Network Keys will not be shown on this page. If selected, the data is encrypted using the key before being transmitted. For example, if you set 128-bit in this field, then the receiving station must be set to use the 128 Bit Encryption, and have the same Key value too. Otherwise, it will not be able to decrypt the data.

*( Note: You need to connect one end of the Ethernet cable to the Ethernet port on the back of your computer, and the other end to the ETHERNET port on the Wireless Gateway. )*

- If you select WEP (**64-bit** or **128-bit**), you can adjust the following settings. And by selecting **Disable** you can disable WEP Encryption.
- **Shared Key Authentication:** Decide whether to set the shared key **Optional** or **Required** by selecting from the drop-down menu.
- **Network Key 1 to 4:** The system allows you to enter four sets of the WEP key. For **64-bit** WEP mode, the key length is 5 characters or 10 hexadecimal digits. As for **128-bit** WEP mode, the key length is 13 characters or 26 hexadecimal digits.
- **Current Network Key:** Select one set of the network key (from 1 to 4) as the default one.
- **PassPhrase:** You can enter ASCII codes into this field. The range is from 8 characters to 64 characters. For **ASCII characters**, you can key in **63** characters in this field. If you want to key in **64** characters, only **hexadecimal characters** can be used.
- **Generate WEP Keys:** Click this button to generate the PassPhrase.
- **Apply:** After proper configuration, click Apply to invoke the settings.



# Chapter 2: WEB Configuration

## 802.1x Authentication

If you enable the **802.1x authentication** function, you will have to offer the following information-

- **RADIUS Server:** RADIUS Server is a protocol for carrying authentication, authorization, and configuration information between a Network Access Server which desires to authenticate its links and a shared Authentication Server. Please key in the IP Address for the RADIUS Server.
- **RADIUS Port:** Besides the IP address of the RADIUS Server, you have to enter the port number for the server. Port 1812 is the reserved RADIUS-authentication port described in RFC 2138. Earlier AP (RADIUS clients) use port 1945. The default value will be shown on this box. You can keep and use it.
- **RADIUS Key:** A RADIUS Key is like a password, which is used between IAS and the specific RADIUS client to verify identity. Both IAS and the RADIUS client must be use the same RADIUS Key for successful communication to occur. Enter the RADIUS Key.

The image shows a configuration form with the following fields and values:

- WPA/WPA2 Encryption: TKIP+AES (dropdown)
- WPA Pre-Shared Key: [Redacted]
- RADIUS Server: 0.0.0.0
- RADIUS Port: 1812
- RADIUS Key: [Redacted]
- Group Key Rotation Interval: 0
- WPA/WPA2 Re-auth Interval: 3600
- WEP Encryption: Disabled (dropdown)
- Shared Key Authentication: Optional (dropdown)
- 802.1x Authentication: Disabled (dropdown)
- Network Key 1: [Redacted]
- Network Key 2: [Redacted]
- Network Key 3: [Redacted]
- Network Key 4: [Redacted]
- Current Network Key: 1 (dropdown)
- PassPhrase: [Redacted]
- Buttons: Generate WEP Keys, Apply

Fig. 32

## Chapter 2: WEB Configuration

### WPA/WPA2

For the WPA/WPA2 network Authentication, the settings that you can adjust including WPA/WPA2 Encryption, RADIUS Server, RADIUS Port, RADIUS Key, Group Key Rotation Interval, and WPA/WPA2 Re-auth Interval.

- **WPA/WPA2 Encryption:** There are three types that you can choose, **TKIP\***, **AES\*\***, **TKIP+AES**.  
**TKIP takes the original master key only as a starting point and derives its encryption keys mathematically from this mater key. Then it regularly changes and rotates the encryption keys so that the same encryption key will never be used twice**  
**\*\* AES provides security between client workstations operating in ad hoc mode. It uses a mathematical cipherring algorithm that employs variable key sizes of 128, 192 or 256 bits.**
- **RADIUS Server/RADIUS Port/RADIUS Key: Please refer to the previous page.**
- **Group Key Rotation Interval:** Key in the time for the WAP group key rotation interval. The unit is second. With increasing rekey interval, user bandwidth requirement is reduced.
- **WPA/WPA2 Re-auth Interval:** When a wireless client has associated with the Wireless Gateway for a period of time longer than the setting here, it would be disconnected and the authentication will be executed again. The default value is *3600*, you may modify it.

The screenshot displays a configuration interface for WPA/WPA2 settings. It includes several dropdown menus and text input fields. The 'WPA' dropdown is set to 'Disabled', 'WPA-PSK' to 'Enabled', 'WPA2' to 'Disabled', and 'WPA2-PSK' to 'Enabled'. The 'WPAWPA2 Encryption' dropdown is set to 'TKIP+AES'. The 'WPA Pre-Shared Key' field is a long text box filled with black dots. The 'RADIUS Server' field contains '0.0.0.0', 'RADIUS Port' contains '1812', and 'RADIUS Key' is a long text box. The 'Group Key Rotation Interval' field contains '0', and the 'WPAWPA2 Re-auth Interval' field contains '3600'.

Fig. 33

# Chapter 2: WEB Configuration

## WPA-PSK/ WPA2-PSK

For the WPA-PSK/WPA2-PSK network Authentication, the settings that you can adjust including WPA/WPA2 Encryption, WPA Pre-Shared Key, and Group key Rotation Interval.

- **WPA Pre-Shared Key:** Please type the key to be between 8 and 63 characters, or 64 hexadecimal digits. Only the devices with a matching key that you set here can join this network.
- **WPA/WPA2 Encryption & WPA Group Rekey Interval:** Please refer to the WPA/WPA2 part.

The screenshot shows a configuration interface for WPA/WPA2. It includes several dropdown menus and text input fields. The 'WPA' dropdown is set to 'Disabled', 'WPA-PSK' to 'Enabled', 'WPA2' to 'Disabled', and 'WPA2-PSK' to 'Enabled'. The 'WPA/WPA2 Encryption' dropdown is set to 'TKIP+AES'. The 'WPA Pre-Shared Key' field contains a series of black dots. The 'RADIUS Server' field contains '0.0.0.0', 'RADIUS Port' contains '1812', and 'RADIUS Key' is an empty field. The 'Group Key Rotation Interval' field contains '0', and 'WPA/WPA2 Re-auth Interval' contains '3600'.

Fig. 34

## Automatic Security Configuration

The screenshot shows the WPS configuration interface. At the top, there is a 'WPS' dropdown menu. Below it, a box displays 'WPS Config State: Unconfigured'. A text block explains that the physical button on the AP will provision wireless clients using Wi-Fi Protected Setup (WPS). Under 'Device Name', the value 'ThomsonAP' is entered. The 'WPS Setup AP' section shows a 'PIN' field with '12345670' and a 'Configure' button. The 'WPS Add Client' section has radio buttons for 'Push-Button' and 'PIN', with 'PIN' selected and an 'Add' button. Below this, there is an empty 'PIN' input field.

Fig. 35

WiFi Protected Setup (WPS) is an easy and secure way of configuring and connecting your WiFi access point. In your case, the DCW775 is the Access Point (AP), and Your PC (or Wifi Device) is called the STA. When configuring your Wifi Network via WPS, Messages are exchanged between the STA and AP in order to configure the Security Settings on both devices.

- **WPS Config:** It will help you to **Enable** or **Disable** the WPS feature. To enable you need to select **WPS**, to disable you need to select **Disabled**.

**Note:** After you **Enabled** the WPS you will get the options as show in Fig.35 and the WPS Config State box

## Chapter 2: WEB Configuration

will show its configuration status.

- **Device Name:** By using this you can change the factory default to a name of your choice which is up to 32 characters long as like **SSID**.
- **WPS Setup AP:** Here you do not need to change anything, just skip this step.
- **WPS Add Client:** There are two methods “Push-Button” and “PIN”. Select the method you want. But, the default selection will be “PIN”.

If you select “Push-Button”, then the **WPS Add Client** option will appear as shown below.

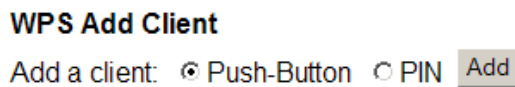

Fig. 36

And then if you click “Add” button then **WPS Setup AP** page will appear as shown in Fig.36

### WPS Setup AP

Your AP is now waiting for the STA to connect.



Fig. 37

And **WPS Configure Status** will be “In progress”, after establishing the connection the **WPS Configure Status** will be “Success!” as shown below. After successful connection the client will get IP address from AP and then internet will be accessible.

### WPS Setup AP SUCCESSFUL

AP Configuration is complete. Click 'Continue' to return to the previous page.



Fig. 38

## Chapter 2: WEB Configuration

If you select **WPS Method** to PIN then it will ask for PIN while configuring the WiFi AP by showing a text box so, you need to enter PIN to establish the connection. You can get the PIN from your connected Wi-Fi client.

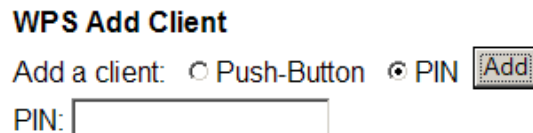

**WPS Add Client**  
Add a client:  Push-Button  PIN   
PIN:

Fig. 39

- **PIN:** Use this option to set the PIN, enter 4-8 digits PIN of the device you wish to configure. After entering the pin click “Add” button, then the WPS Setup AP page will appear as shown in Fig.38

## WPS Setup AP

Your AP is now waiting for the STA to connect.

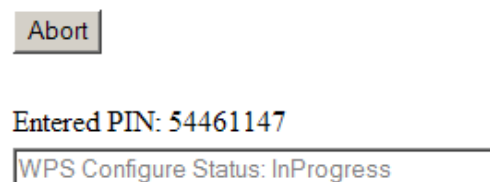

Entered PIN: 54461147  
WPS Configure Status: InProgress

Fig. 40

And **WPS Configure Status** will be “In progress”, after establishing the connection the **WPS Configure Status** will be “Success!” as shown below. After successful connection the client will get IP address from AP and then internet will be accessible.

## WPS Setup AP SUCCESSFUL

AP Configuration is complete. Click 'Continue' to return to the previous page.



Entered PIN:  
WPS Configure Status: Success!

Fig. 41

# Chapter 2: WEB Configuration

## 3. Access Control

This page allows you to make access control to the AP (Access Point) or connected clients by offering the MAC Addresses of the clients.

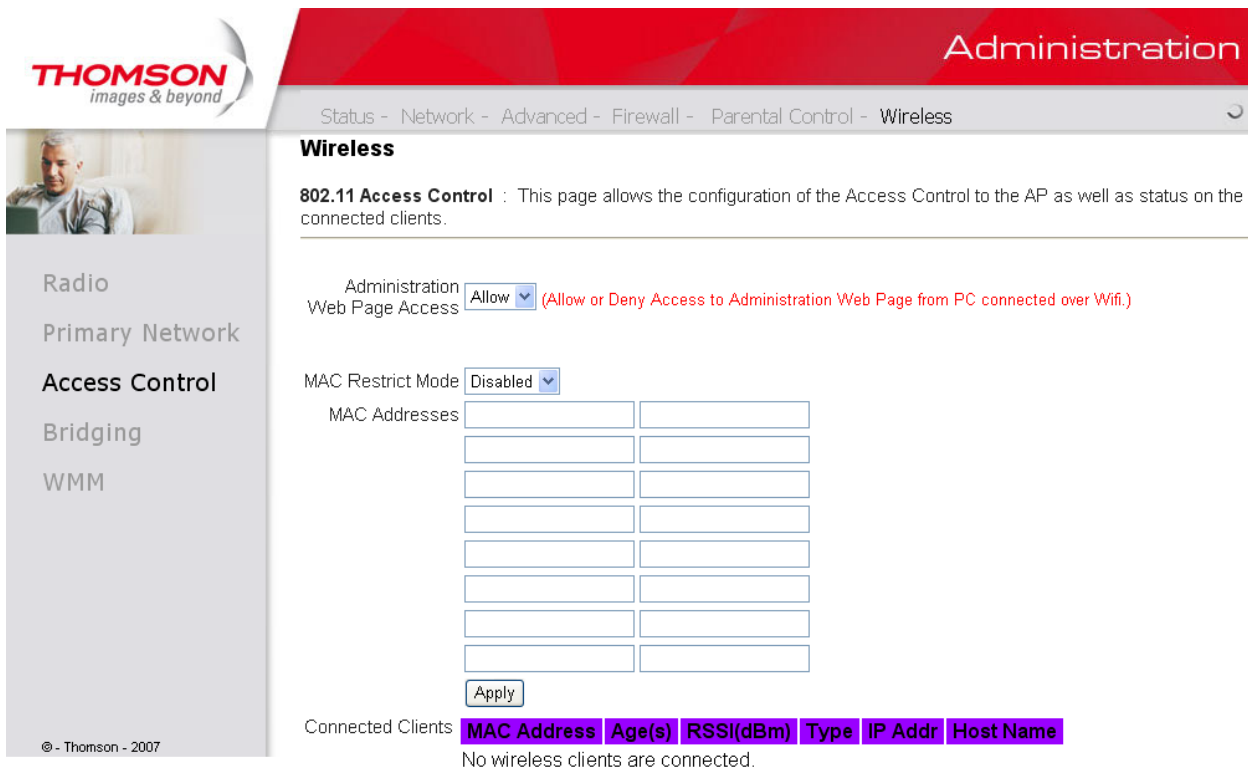

Fig. 42

**Administration Web page Access:** It Allow or Deny access to Administration Web Page from PC connected over WiFi.

**Wireless Interface:** By default it will be having two interfaces, “Primary Network interface” and “Guest Network Interface”. The “Primary Network interface” will be available for all users. If you want to access the “Guest Network Interface” then you need to contact cable operator.

**MAC Restrict Mode:** Click **Disabled** to welcome all of the clients on the network; select **Allow** to permit only the clients on the list to access the cable modem; or choose **Deny** to prevent the clients on the list to access this device.

**MAC Address:** Your Gateway identifies wireless PCs by their WiFi MAC Address. This address consists of a string of 6 pairs of numbers 0-9 and letters A-F, such as 00 90 4B F0 FF 50. It is usually printed on the WiFi card of the device (e.g. the PCMCIA card in a laptop). It can also be determined from a Windows DOS prompt as explained below.

Enter the MAC addresses of the connected clients into the fields, and then click Apply to add them to the list for access control.

**Apply:** After proper configuration, click Apply to invoke the settings.

**Connected Clients:** The information of currently connected clients will be displayed here.

# Chapter 2: WEB Configuration

## 4. Bridging

The Bridging page provides a location where settings can be adjusted related to the WDS (**Wireless Distribution System**) feature.

WDS is a system that enables the interconnection of access points wirelessly. It may also be referred to as repeater mode because it appears to bridge and accept wireless clients at the same time (unlike traditional bridging).

The wireless gateway can be placed in a mode that allows the gateway to communicate with other “extender” wireless access points either exclusively or mixed with communications to local PCs. Use this page to designate the Remote Bridges the gateway is allowed to communicate with, and to select the Wireless Bridging mode.

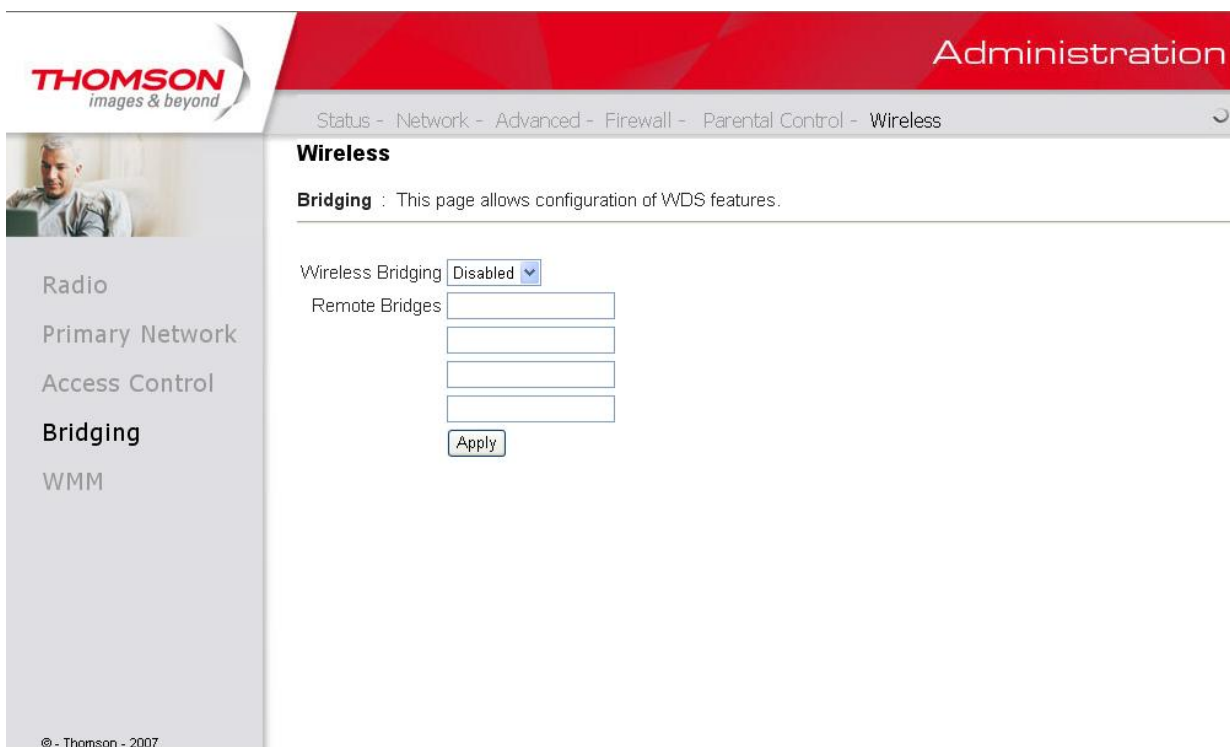

Fig. 43

- **Wireless Bridging:**  
Choose **Disabled** to shutdown this function; select **Enabled** to turn on the function of WDS.
- **Remote Bridges:**  
Enter the MAC Addresses of the remote Bridges to relay the signals to each other.
- **Apply:**  
After proper configuration, click Apply to invoke the settings.

# Chapter 2: WEB Configuration

## 5. 802.11 QoS (WMM) Settings

Wi-Fi Multimedia (WMM) is a component of the IEEE 802.11e wireless LAN standard for quality of service (QoS). The QoS assigns priority to the selected network traffic and prevents packet collisions and delays thus improving VoIP calls and watching video over WLANs.

- **Enable WMM:**  
This field allows you to enable WMM to improve multimedia transmission.
- **Enable WMM No-Acknowledgement:**  
This field allows you to enable WMM No-Acknowledgement.
- **Power Save Support:**  
This field allows you to enable WMM Power-Save-Support.

The screenshot shows the Thomson Administration web interface. The top navigation bar includes 'Status - Network - Advanced - Firewall - Parental Control - Wireless'. The main content area is titled 'Wireless' and contains the '802.11 Wi-Fi Multimedia' configuration page. The page includes three settings: 'WMM Support' (On), 'No-Acknowledgement' (Off), and 'Power Save Support' (On). Below these are two tables for EDCA parameters. The first table is for AP parameters and the second is for STA parameters. Both tables have columns for AC\_BE, AC\_BK, AC\_VI, AC\_VO, CWmin, CWmax, AIFSN, TXOP(b) Limit (usec), TXOP(a/g) Limit (usec), and Discard Oldest First. The 'Apply' button is visible at the bottom of each table.

EDCA AP Parameters:	CWmin	CWmax	AIFSN	TXOP(b) Limit (usec)	TXOP(a/g) Limit (usec)	Discard Oldest First
AC_BE	15	63	3	0	0	Off
AC_BK	15	1023	7	0	0	Off
AC_VI	7	15	1	6016	3008	Off
AC_VO	3	7	1	3264	1504	Off

EDCA STA Parameters:	CWmin	CWmax	AIFSN	TXOP(b) Limit (usec)	TXOP(a/g) Limit (usec)
AC_BE	15	1023	3	0	0
AC_BK	15	1023	7	0	0
AC_VI	7	15	2	6016	3008
AC_VO	3	7	2	3264	1504

Fig. 44



## Chapter 2: WEB Configuration

### EDCA AP Parameters:

The parameters for Access Point (AP) of EDCA (enhanced distributed channel access).

### EDCA STA Parameters:

The parameters for WIFI station of EDCA.

**CWmin:** This attribute shall specify the value of the minimum size of the window that shall be used by a QAP for a particular AC for generating a random number for the backoff.

**CWmax:** This attribute shall specify the value of the maximum size of the window that shall be used by a QAP for a particular AC for generating a random number for the backoff.

**AIFSN:** This attribute shall specify the number of slots, after a SIFS duration, that the QAP, for a particular AC, shall sense the medium idle either before transmitting or executing a backoff.

### TXOP (b) Limit (usec)/ TXOP (a/g) Limit (usec):

This attribute shall specify the maximum number of microseconds of an EDCA TXOP for a given AC at the QAP.

### Discard Oldest First

If buffer full and parameter is TRUE then discard oldest first.

4 AC's (Access Category) are defined:

AC\_BK (background)

AC\_BE (best-effort)

AC\_VI (Video)

AC\_VO (Voice)

## Chapter 3: Networking

### Communications

Data communication involves the flow of packets of data from one device to another. These devices include personal computers, Ethernet, cable modems, digital routers and switches, and highly integrated devices that combine functions, like the Wireless Cable Gateway.

The gateway integrates the functionality often found in two separate devices into one. It's both a cable modem and an intelligent wireless gateway networking device that can provide a host of networking features, such as NAT and firewall. Figure 2 illustrates this concept, with the cable modem (CM) functionality on the left, and networking functionality on the right. In this figure, the numbered arrows represent communication based on source and destination, as follows:

### Type of Communication

1. Communication between the Internet and your PCs

Example: The packets created by your request for a page stored at a web site, and the contents of that page sent to your PC.

2. Communication between your cable company and the cable modem side

Example: When your cable modem starts up, it must initialize with the cable company, which requires the cable company to communicate directly with the cable modem itself.

3. Communication between your PCs and the networking side

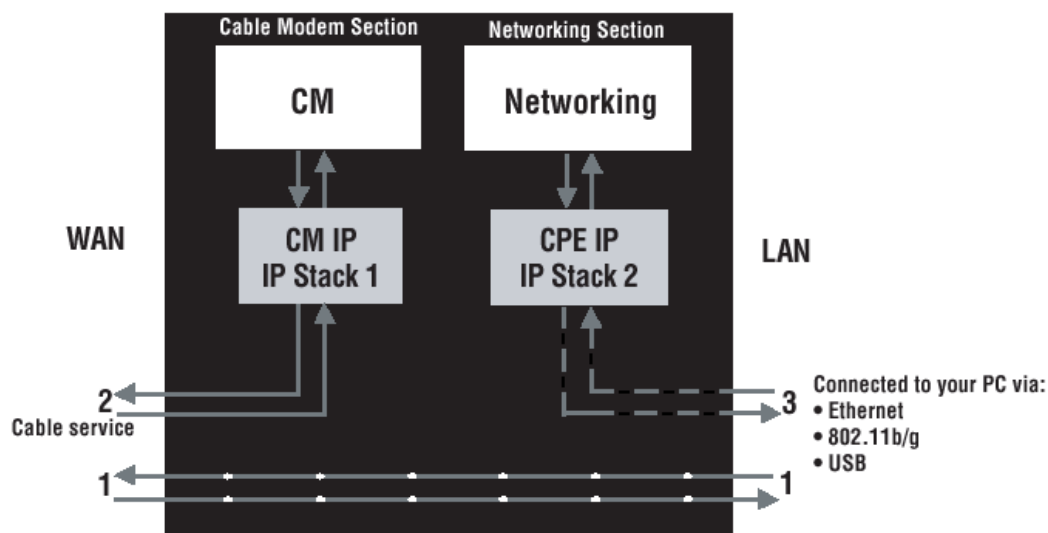

Fig.45

# Chapter 3: Networking

Example: The Wireless Cable Gateway offers a number of built-in web pages which you can use to configure its networking side; when you communicate with the networking side, your communication is following this path.

Each packet on the Internet addressed to a PC in your home travels from the Internet downstream on the cable company's system to the WAN side of your Wireless Cable Gateway. There it enters the Cable Modem section, which inspects the packet, and, based on the rules, proceeds to either forward or block the packet from proceeding on to the Networking section. Similarly, the Networking section then decides whether to forward or block the packet from proceeding on to your PC. Communication from your home device to an Internet device works similarly, but in reverse, with the packet traveling upstream on the cable system.

## Cable Modem (CM) Section

The cable modem (or CM) section of your gateway uses DOCSIS Standard cable modem technology. DOCSIS specifies that TCP/IP over Ethernet style data communication be used between the WAN interface of your cable modem and your cable company.

A DOCSIS modem, when connected to a Cable System equipped to support such modems, performs a fully automated initialization process that requires no user intervention. Part of this initialization configures the cable modem with a CM IP (Cable Modem Internet Protocol) address, as shown in Figure 3, so the cable company can communicate directly with the CM itself.

## Networking Section

The Networking section of your gateway also uses TCP/IP (Transmission Control Protocol/ Internet Protocol) for the PCs you connected on the LAN side. TCP/IP is a networking protocol that provides communication across interconnected networks, between computers with diverse hardware architectures and various operating systems.

TCP/IP requires that each communicating device be configured with one or more TCP/IP stacks, as illustrated by Figure 4. On a PC, you often use software that came with the PC or its network interface (if you purchased a network interface card separately) to perform this configuration. To communicate with the Internet, the stack must also be assigned an IP (Internet Protocol) address. 192.168.100.1 is an example of an IP address. A TCP/IP stack can be configured to get this IP address by various means, including a DHCP server, by you directly entering it, or sometimes by a PC generating one of its own.

Ethernet requires that each TCP/IP stack on the Wireless Cable Gateway also have associated with it an Ethernet MAC (Media Access Control) address. MAC addresses are permanently fixed into network devices at the time of their manufacture. 00:90:64:12:B1:91 is an example of a MAC address.

Data packets enter and exit a device through one of its network interfaces. The gateway offers Ethernet and 802.11b/g wireless network interfaces on the LAN side and the DOCSIS network interface on the WAN side.

# Chapter 3: Networking

When a packet enters a network interface, it is offered to all the TCP/IP stacks associated with the device side from which it entered. But only one stack can accept it — a stack whose configured Ethernet address matches the Ethernet destination address inside the packet. Furthermore, at a packet's final destination, its destination IP address must also match the IP address of the stack.

Each packet that enters a device contains source MAC and IP addresses telling where it came from, and destination MAC and IP addresses telling where it is going to. In addition, the packet contains all or part of a message destined for some application that is running on the destination device. IRC used in an Internet instant messaging program, HTTP used by a web browser, and FTP used by a file transfer program are all examples of applications. Inside the packet, these applications are designated by their port number. Port 80, the standard HTTP port, is an example of a port number.

The Networking section of the router performs many elegant functions by recognizing different packet types based upon their contents, such as source and destination MAC address, IP address, and ports.

## Three Networking Modes

Your gateway can be configured to provide connectivity between your cable company and your home LAN in any one of three Networking Modes: CM, RG, and CH. This mode setting is under the control of your cable company, who can select the mode to match the level of home networking support for which you have subscribed. By default, all units are set for the RG mode, however; your cable company may change these defaults during device initialization.

### Cable Modem (CM) Mode

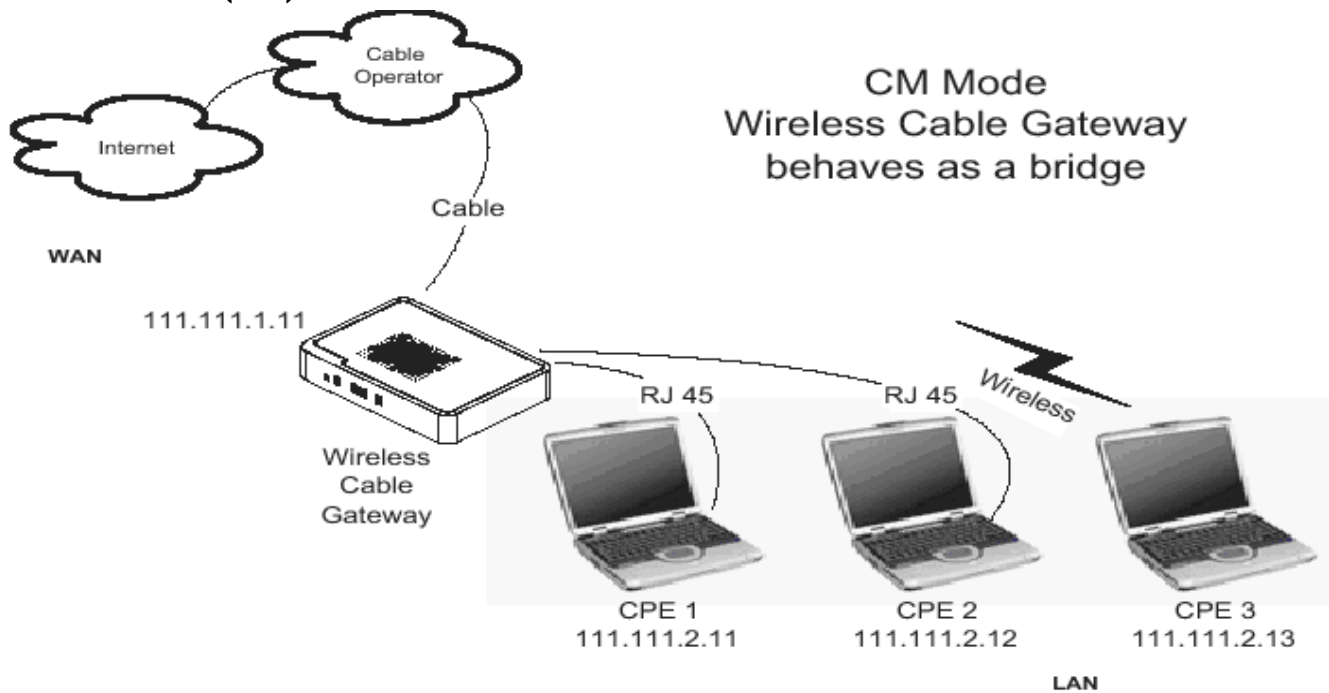

Fig.46

## Chapter 3: Networking

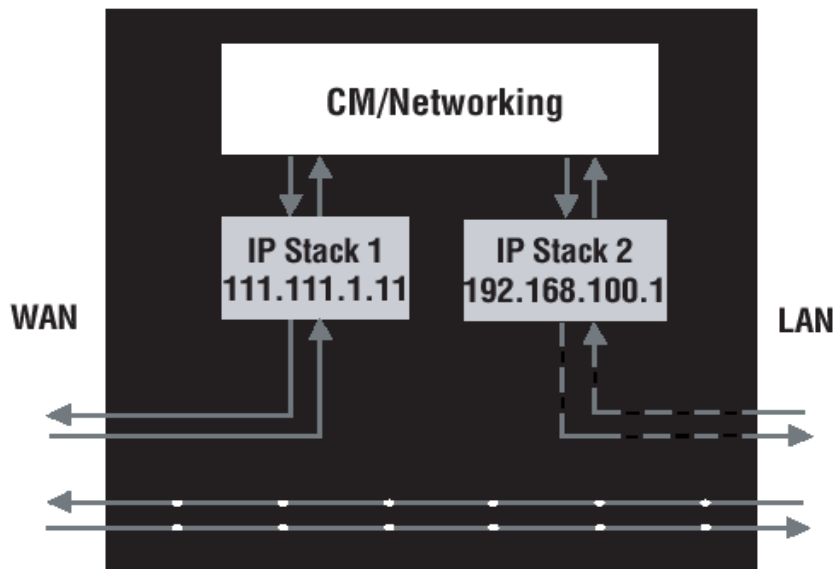

Fig. 47

CM (Cable Modem) Mode provides basic home networking. In this mode, two IP stacks are active:

- IP Stack 1 - for use by the cable company to communicate with the cable modem section only. This stack receives its IP address from the cable company during CM initialization. It uses the MAC address printed on the label attached to the Wireless Cable gateway.
- IP Stack 2 - for use by you, the end user, to communicate with the cable modem and Networking sections, to access the internal web page diagnostics and configuration. This stack uses a fixed IP address: 192.168.100.1. It uses a MAC address of MAC label + 1 (the MAC label is found on the bottom of the unit). E.g., if the MAC address is 00:90:64:12:B1:91, this MAC address would be 00:90:64:12:B1:92.

With CM Mode, your cable company must provide one IP address for the CM section, plus one for each PC you connect from their pool of available addresses. Your cable company may have you or your installer manually enter these assigned addresses into your PC, or use a DHCP Server to communicate them to your PCs, or use a method that involves you entering host names into your PCs.

Note that in CM Mode, packets passing to the Internet to/from your PCs do not travel through any of the IP stacks; instead they are directly bridged between the WAN and LAN sides.

## Residential Gateway (RG) Mode

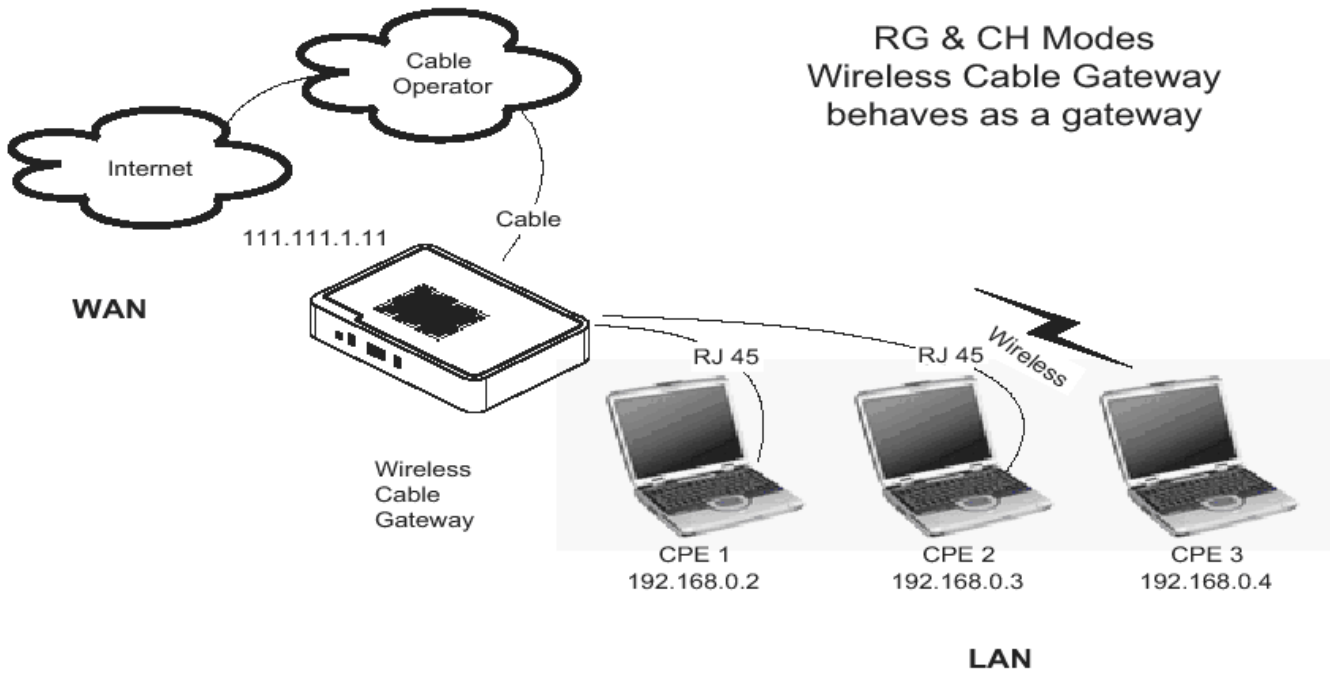

Fig. 48

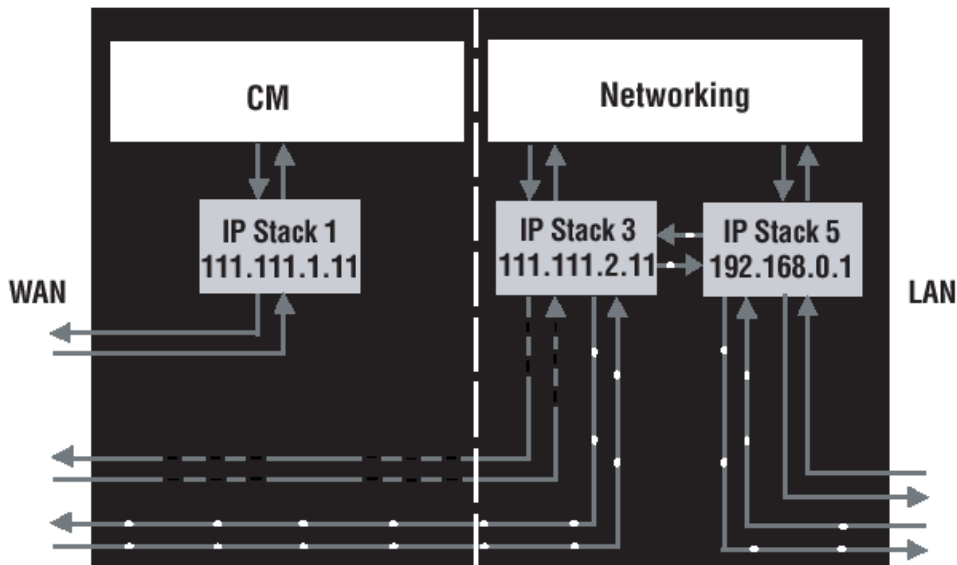

Fig. 49

RG (Residential Gateway) Mode provides basic home networking plus NAT (Network Address Translation). In this mode, three IP stacks are active:

- IP Stack 1 - for use by the cable company to communicate with the Cable Modem section only. This stack receives its IP address from the cable company during CM initialization. It uses the MAC address printed on the label attached to the Wireless Cable Gateway.

# Chapter 3: Networking

- IP Stack 3 - for use by you to remotely (i.e. from somewhere on the WAN side, such as at your remote workplace) communicate with the Cable Modem and Networking sections, to remotely access the internal web page diagnostics and configuration. This stack is also used by your cable company to deliver packets between the Internet and the gateway's networking section so they can be routed to/from your PCs. This stack requires an IP address assigned by the cable company from their pool of available addresses. This stack uses a MAC address of MAC label + 2 (the MAC label is found on the bottom of the unit). E.g., if the MAC address is 00:90:64:12:B1:91, this MAC address would be 00:90:64:12:B1:93.
- IP Stack 5 - for use by you to locally (i.e. from somewhere on the LAN side in your home) communicate with the Cable Modem and Networking sections, to access the internal web page diagnostics and configuration. This stack is also used by the gateway's networking section to route packets between the gateway's Networking section and your PCs. This stack uses a fixed IP address: 192.168.0.1. It uses a MAC address of MAC label + 4 (the MAC label is found on the bottom of the unit). E.g., if the MAC address is 00:90:64:12:B1:91, this MAC address would be 00:90:64:12:B1:95.

With RG Mode, your cable company must provide one IP address for the CM section, plus one for the Networking section, from their pool of available addresses. With RG Mode, each PC you connect gets an IP address from a DHCP Server that is part of the Networking section of the gateway.

## CableHome (CH) Mode

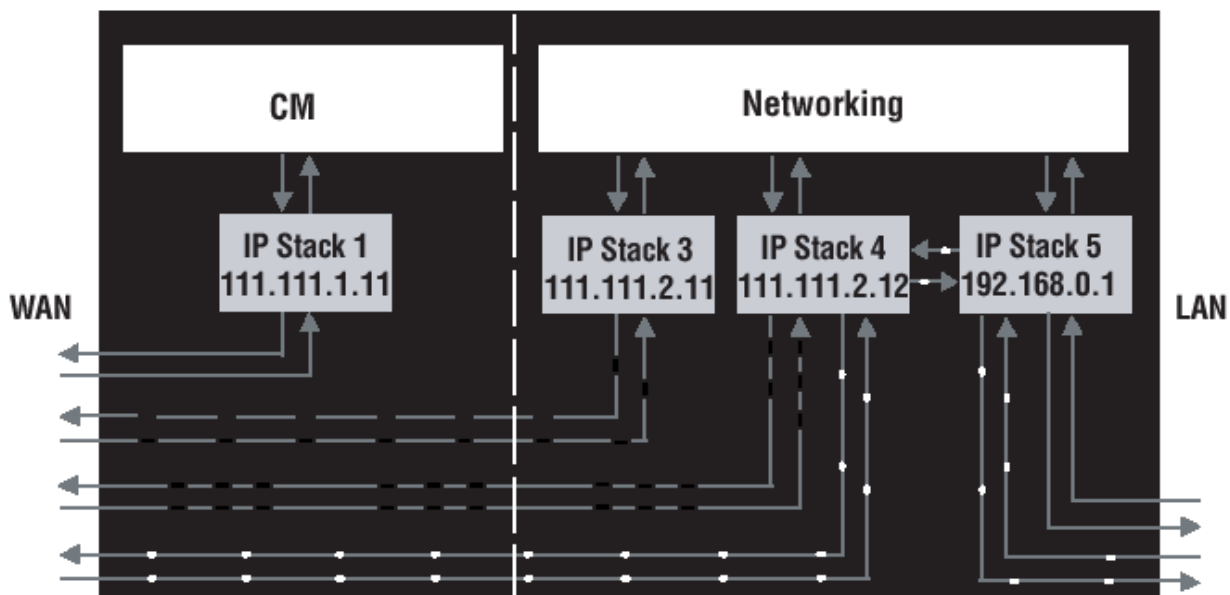

Fig. 50

## Chapter 3: Networking

CH (CableHome) Mode provides all the functionality of RG mode and adds the ability of the cable company to control the home networking configuration of your Wireless Cable Gateway for you, so you don't need to perform the configuration yourself. In this mode, four IP stacks are active:

- IP Stack 1 - for use by the cable company to communicate with the Cable Modem section only. This stack receives its IP address from the cable company during CM initialization. It uses the MAC address printed on the label attached to the Wireless Cable Gateway.
- IP Stack 3 - for use by your cable company to communicate with the Networking section to help you configure and manage your home networking. This stack requires an IP address assigned by the cable company from their pool of available addresses. Your cable company may have you or your installer manually enter assigned addresses into your gateway, or use a DHCP Server to communicate them, or use a method that involves you entering host names. This stack uses a MAC address of MAC label + 2 (the MAC label is found on the bottom of the unit). E.g., if the MAC address is 00:90:64:12:B1:91, this MAC address would be 00:90:64:12: B1:93.
- IP Stack 4 - for use by you to remotely (i.e. from somewhere on the WAN side, such as at your remote workplace) communicate with the Cable Modem and Networking sections, to remotely access the internal web page diagnostics and configuration. This stack is also used by your cable company to deliver packets between the Internet and the Wireless Cable Gateway's Networking section so they can be routed to/from your PCs. This stack requires an IP address assigned by the cable company from their pool of available addresses. Your cable company may have you or your installer manually enter these assigned addresses into your gateway, or use a DHCP Server to communicate them, or use a method that involves you entering host names. This stack uses a MAC address of MAC label + 3 (the MAC label is found on the bottom of the unit). E.g., if the MAC address is 00:90:64:12:B1:91, this MAC address would be 00:90: 64:12:B1:94.
- IP Stack 5 - for use by you to locally (i.e. from somewhere on the LAN side in your home) communicate with the Cable Modem and Networking sections, to access the internal web page diagnostics and configuration. This stack is also used by the Wireless Cable Gateway Networking section to route packets between the Wireless Cable Gateway's Networking section and your PCs. This stack uses a fixed IP address: 192.168.0.1. It uses a MAC address of MAC label+ 4 (the MAC label is found on the bottom of the unit). E.g., if the MAC address is 00:90:64:12:B1:91, this MAC address would be 00:90:64:12:B1:95.

With CH Mode, your cable company must provide one IP address for the CM section, plus two for the Networking section, from their pool of available addresses. Each PC you connect gets an IP address from a DHCP Server that is part of the Networking section of the gateway.



## Chapter 3: Networking

### MAC and IP Addresses Summary

This table summarizes all the MAC and IP addresses that may be associated with the TCP/IP communication stacks in your Wireless Cable Gateway. The ones actually used depend upon your gateway Operating Mode, as explained above. At minimum, your cable company will need to know the MAC address associated with IP Stack 1, which is the MAC address shown on the modem label.

Stack Name	Purpose - Mode	MAC Address	IP Address
IP Stack 1	CM WAN access - all Modes	per label on CM	assigned by cable company
IP Stack 2	local management - CM Mode		during initialization
IP Stack 3	only	CM label + 1	fixed at 192.168.100.1
IP Stack 4			
IP Stack 5	CableHome remote management	CM label + 2	assigned by cable company
---	- CH Mode only	CM label + 3	assigned by cable company
	end-user remote management, LAN WAN access - RG Mode only		
	WAN data access - CH Mode only	CM label + 4	fixed at 192.168.0.1
	local management - RG, CH Modes only LAN gateway	CM label + 5	

MAC and IP Addresses

### Chapter 4: Additional Information

#### Frequently Asked Questions

***Q. What if I don't subscribe to cable TV?***

A. If cable TV is available in your area, data and voice service may be made available with or without cable TV service. Contact your local cable company for complete information on cable services, including high-speed internet access.

***Q. How do I get the system installed?***

A. Professional installation from your cable provider is strongly recommended. They will ensure proper cable connection to the modem and your computer. However, your retailer may have offered a self installation kit, including the necessary software to communicate with your cable ISP.

***Q. Once my Wireless Gateway is connected, how do I get access to the Internet?***

A. Your local cable company provides your internet service\*, offering a wide range of services including email, chat, and news and information services, and a connection to the World Wide Web.

***Q. Can I watch TV, surf the Internet, and talk to my friends through the Wireless Gateway at the same time?***

A. Absolutely!

***Q. What do you mean by "Broadband?"***

A. Simply put, it means you'll be getting information through a "bigger pipe," with more bandwidth, than a standard phone line can offer. A wider, "broader" band means more information, more quickly.

***Q. What is DOCSIS and what does it mean?***

A. "Data over Cable Service Interface Specifications" is the industry standard that most cable companies are adopting as they upgrade their systems. Should you ever decide to move, the Wireless Gateway will work with all upgraded cable systems that are DOCSIS-compliant.

***Q. What is Xpress Technology and what does it mean?***

A. It is one of the popular performance-enhancing WiFi technologies, designed to improve wireless network efficiency and boost throughput. It is more efficient in mixed environments, and it can work with 802.11a/b/g networks. When Xpress is turned on, aggregate throughput (the sum of the individual throughput speeds of each client on the network) can improve by **up to 27%** in 802.11g-only networks, and **up to 75%** in mixed networks comprised of 802.11g and 802.11b standard equipment. The technology achieves higher throughput by re-packaging data, reducing the number of overhead control

## Chapter 4: Additional Information

packets, so that more useful data can be sent during a given amount of time.

\* Monthly subscription fee applies.

\*\* Additional equipment required. Contact your cable company and ISP for any restrictions or additional fees.

# Chapter 4: Additional information

## General Troubleshooting

---

You can correct most problems you have with your product by consulting the troubleshooting list that follows.

### **I can't access the internet.**

- Check all connections to your Wireless Gateway.
- Your Ethernet card may not be working. Check each product's documentation for more information.
- The Network Properties of your operating system may not be installed correctly or the settings may be incorrect. Check with your ISP or cable company.

### **I can't get the modem to establish an Ethernet connection.**

- Even new computers don't always have Ethernet capabilities – be sure to verify that your computer has a properly installed Ethernet card and the driver software to support it.
- Check to see that you are using the right type of Ethernet cable.

### **The modem won't register a cable connection.**

- If the modem is in Initialization Mode, the INTERNET light will be flashing. Call your Cable Company if it has not completed this 5-step process within 30 minutes, and note which step it is getting stuck on.
- The modem should work with a standard RG-6 coaxial cable, but if you're using a cable other than the one your Cable Company recommends, or if the terminal connections are loose, it may not work. Check with your Cable Company to determine whether you're using the correct cable.
- If you subscribe to video service over cable, the cable signal may not be reaching the modem. Confirm that good quality cable television pictures are available to the coaxial connector you are using by connecting a television to it. If your cable outlet is "dead", call your Cable Company.
- Verify that the Cable Modem service is DOCSIS compliant by calling your cable provider.

For more Usage and Troubleshooting Tips use the web site links provided on the CD-ROM:

<http://www.cable-modem.rca.com/help>

# Chapter 4: Additional Information

## FCC Declaration of Conformity and Industry Canada Information

---

This device complies with Part 15 of the FCC Rules. Operation is subject to the following two conditions: (1) this device may not cause harmful interference, and (2) this device must accept any interference received, including interference that may cause undesired operation.

Trade Name:	Model: DCW775
Equipment Classification:	Computing Device Accessory
Responsible Party:	Thomson Inc. 101 W 103rd Street Indianapolis, IN 46290 Telephone 317-415-4151

This equipment has been tested and found to comply with the limits for a Class B digital device, pursuant to Part 15 of the FCC Rules. These limits are designed to provide reasonable protection against harmful interference in a residential installation. This equipment generates, uses, and can radiate radio frequency energy and, if not installed and used in accordance with the instructions, may cause harmful interference to radio communications. However there is no guarantee that interference will not occur in a particular installation. If this equipment does cause harmful interference to radio or television reception, which can be determined by turning the equipment off and on, the user is encouraged to try and correct the interference by one or more of the following measures:

- Reorient or relocate the receiving antenna.
- Increase the separation between the equipment and receiver.
- Connect this equipment into an outlet on a circuit different from that to which the receiver is connected.
- Consult the dealer or an experienced radio/TV technician for help.

FCC regulations state that unauthorized changes or modifications to this equipment may void the user's authority to operate it.

This Class B digital apparatus meets all requirements of the Canadian Interference Causing Equipment Regulations.

# Chapter 4: Additional information

For operation within 5.15 ~ 5.25GHz frequency range, it is restricted to indoor environment.

IEEE 802.11b or 802.11g operation of this product in the U.S.A. is firmware-limited to channels 1 through 11.

## **IMPORTANT NOTE:**

### **FCC Radiation Exposure Statement:**

This equipment complies with FCC radiation exposure limits set forth for an uncontrolled environment. This equipment should be installed and operated with minimum distance 20cm between the radiator & your body.

*This transmitter must not be co-located or operating in conjunction with any other antenna or transmitter.*

## **Service Information**

---

If you purchased or leased your Wireless Gateway directly from your cable company, then warranty service for the Digital Cable Modem may be provided through your cable provider or its authorized representative. For information on 1) Ordering Service, 2) Obtaining Customer Support, or 3) Additional Service Information, please contact your cable company. If you purchased your Wireless Gateway from a retailer, see the enclosed warranty card.

# Chapter 4: Additional Information

## Glossary

---

**10BaseT** – Unshielded, twisted pair cable with an RJ-45 connector, used with Ethernet LAN (Local Area Network). “10” indicates speed (10 Mbps), “Base” refers to baseband technology, and “T” means twisted pair cable.

**Authentication** - The process of verifying the identity of an entity on a network.

**DHCP (Dynamic Host Control Protocol)** – A protocol which allows a server to dynamically assign IP addresses to workstations on the fly.

**Ethernet card** – A plug-in circuit board installed in an expansion slot of a personal computer. The Ethernet card (sometimes called a Network Interface Card or NIC) takes parallel data from the computer, converts it to serial data, puts it into a packet format, and sends it over the 10BaseT or 100BaseT LAN cable.

**DOCSIS (Data Over Cable Service Interface Specifications)** – A project with the objective of developing a set of necessary specifications and operations support interface specifications for Cable Modems and associated equipment.

**F Connector** – A type of coaxial connector, labeled CABLE IN on the rear of the Wireless Gateway, that connects the modem to the cable system.

**HTTP (HyperText Transfer Protocol)** – Invisible to the user, HTTP is used by servers and clients to communicate and display information on a client browser.

**Hub** – A device used to connect multiple computers to the Wireless Gateway.

**IP Address** – A unique, 32-bit address assigned to every device in a network. An IP (Internet Protocol) address has two parts: a network address and a host address. This modem receives a new IP address from your cable operator via DHCP each time it goes through Initialization Mode.

**Key exchange** - The swapping of mathematical values between entities on a network in order to allow encrypted communication between them.

**MAC Address** – The permanent “identity” for a device programmed into the Media Access Control layer in the network architecture during the modem’s manufacture.

**Network Driver** – A file that is loaded on the computer to allow the computer to recognize the Ethernet card or USB port

**NID** - Network Interface Device, the interconnection between the internal house telephone wiring and a conventional telephone service provider’s equipment. These wiring connections are normally housed in a small plastic box located on an outer wall of the house. It is the legal demarcation between the subscriber’s property and the service provider’s property.

## Chapter 4: Additional information

**TCP/IP (Transmission Control Protocol/Internet Protocol)** – A networking protocol that provides communication across interconnected networks, between computers with diverse hardware architectures and various operating systems.

**TFTP** - Trivial File Transfer Protocol, the system by which the Media Terminal Adapter's configuration data file is downloaded.

**Xpress Technology** - One of the popular performance-enhancing WiFi technologies, designed to improve wireless network efficiency and boost throughput. It is more efficient in mixed environments, and it can work with 802.11a/b/g networks.

---

Please do not send any products to the Indianapolis address listed in this manual or on the carton. This will only add delays in service for your product.

**Thomson Inc.**

101 W 103rd Street

Indianapolis, IN 46290



For more information

Thomson | 46, quai Alphonse Le Gallo | 92100 Boulogne-Billancourt | France  
Tel. : 33 (0) 1 41 86 50 00 | Fax : 33 (0) 1 41 86 56 59 | [www.thomson-broadband.com](http://www.thomson-broadband.com)

© 2007 Thomson Inc.- Trademark(s) ® Registered\ -Marca(s) Registrada(s)\  
Photos and features subject to change without notice.  
Illustration of product finish may vary from actual color.

**THOMSON**