



Powering the **Connected Home**

# SmartRG™ Residential Gateways

---

*April 30, 2012 Version 2.0*

---

## Table of Contents

---

Introduction.....	6
Who Should Read This User's Manual.....	6
Additional Information.....	6
Contacting SmartRG Inc. ....	6
SmartRG™ Residential Gateways .....	7
Advanced Features.....	7
Connect-and-Surf (Automatic WAN Configuration).....	7
Activation (Automatic ACS Connection Configuration) .....	7
Cisco™ Prime Home™ TR-069 Client .....	8
Prime Home™ Gateway Resident Advanced Applications .....	8
SmartRG™ Product Family.....	9
Front Panel LEDs.....	10
Rear Panel Connectors .....	11
SR10.....	11
SR-100 .....	11
SR-350N.....	12
SR-350NE .....	12
SR-500N/SR-500NE .....	13
Connecting a Computer to Your SmartRG™ Gateway .....	14
Navigating Your SmartRG Gateway's Web UI .....	14
Configuring Your SmartRG™ - Common Use Cases .....	16
Use Case: Creating WAN Connections for Internet Access and Remote Management .....	16
Configuring the Layer 2 Interface (Ethernet).....	17
Configuring the Layer 2 Interface (Ethernet with VLAN Tags).....	18
Configuring the Layer 2 Interface (ADSL).....	19
Configuring the Layer 2 Interface (VDSL/PTM) .....	20
Configuring the Layer 2 Interface (VDSL/PTM with VLAN Tags).....	21
Creating the WAN Service .....	22
Use Case: Provisioning Your SmartRG for Remote ACS Management .....	28
Use Case: Setting Up the LAN .....	29
Use Case: Setting Up Wireless .....	31
Use Case: Setting Up Wireless Distribution System (WDS).....	33
Use Case: Creating IPTV Service Configurations.....	35
Bridged IPTV Configuration .....	36
Creating Bridged WAN Connections .....	37
Routed IPTV Configuration (Single WAN Connection) .....	43
Routed IPTV Configuration (Multiple WAN Connections).....	44
Use Case: Applying Quality of Service (QoS) to VoIP and IPTV LAN Traffic.....	45

---

Managing Your SmartRG™ Gateway .....	52
Save, Restore or Default Configurations .....	52
Update Software .....	52
Configure Time Settings .....	53
Configure Access Controls (HTTP, Telnet, SSH, etc.) .....	54
Configure User Logins .....	55
Reset the Gateway.....	56
Hardware Reset .....	56
Hardware Reset (to Factory Default Settings) .....	56
Software Reset.....	56
Troubleshooting.....	57
Accessing System Logs.....	57
Executing Diagnostics .....	58
Technical Support .....	59

## List of Figures

Figure 1 SmartRG Front Panel LEDs.....	10
Figure 2 SR10 Rear Panel Connectors.....	11
Figure 3 SR100 Rear Panel Connectors .....	11
Figure 4 SR350N Rear Panel Connectors.....	12
Figure 5 SR350NE Rear Panel Connectors .....	12
Figure 6 SR500N/NE Rear Panel Connectors.....	13
Figure 7 Login Username and Password.....	14
Figure 8 Device Info Page.....	15
Figure 9 Internet / TR-069 Management WAN Connection .....	17
Figure 10 Ethernet Layer 2 Interface Configuration (Default).....	17
Figure 11 Ethernet Layer 2 Interface Configuration (VLAN Tagged).....	18
Figure 12 ADSL Layer 2 Interface Configuration .....	19
Figure 13 VDSL Layer 2 Interface Configuration .....	20
Figure 14 WAN Service Configuration (With or Without VLAN Tagging Support).....	22
Figure 15 PPP Username and Password .....	23
Figure 16 WAN IP Settings.....	24
Figure 17 WAN NAT, Firewall and IGMP Settings.....	27
Figure 18 TR-069 Management Settings.....	28
Figure 19 LAN Settings .....	29
Figure 20 Adding DHCP Static IP Leases.....	30
Figure 21 Wireless - Basic Settings.....	31
Figure 22 Wireless - Security Settings.....	32
Figure 23 Wireless Distribution System.....	33
Figure 24 Bridged IPTV Configuration .....	35
Figure 25 Routed IPTV Configuration .....	35
Figure 26 Multi-WAN Connection Bridged IPTV Configuration .....	36
Figure 27 Selecting a Bridged WAN Service's Layer 2 Interface .....	37
Figure 28 Creating a Bridged WAN Service .....	38
Figure 29 IPTV Layer 2 Interface Summary (Multi-WAN Bridge Group).....	39
Figure 30 IPTV WAN Service Summary (Multi-WAN Bridge Group) .....	40
Figure 31 Creating an IPTV Bridge Interface Group .....	40
Figure 32 Defining an IPTV Bridge Interface Group .....	41
Figure 33 Typical IPTV Bridge Interface Group.....	42
Figure 34 Routed IPTV Configuration (Single WAN Connection).....	43
Figure 35 Routed IPTV Configuration (Multiple WAN Connections) .....	44
Figure 36 Typical QoS configuration to support VoIP and IPTV services .....	45
Figure 37 Enable the SmartRG's QoS Processing .....	46
Figure 38 QoS: VoIP Queue Configuration .....	46
Figure 39 QoS: IPTV Queue Configuration .....	47
Figure 40 QoS Queue Enable .....	48
Figure 41 QoS VoIP Classifier Configuration .....	49
Figure 42 QoS IPTV Classifier Configuration .....	50

Figure 43 QoS VoIP and IPTV Classifier Config ..... 51  
Figure 44 Time Zone and NTP Server Settings ..... 53  
Figure 45 Enabling/Disabling HTTP, Telnet, SSH ... Access ..... 54  
Figure 46 Configuring the System Log for Use In Troubleshooting..... 57

## Introduction

This document describes the features, functions and administration of SmartRG™ residential gateways.

### Who Should Read This User's Manual

The information in this document is intended for Network Architects, NOC Administrators, Field Service Technicians and other networking professionals responsible for deploying and managing broadband access networks.

### Additional Information

You may find the following documents to be helpful during your access network deployment:

- SmartRG Data Sheets
- SmartRG Product Release Notes
- Deployment and Provisioning Presentation
- Cisco™ Prime Home™ Modules List

### Contacting SmartRG Inc.

Contact SmartRG Inc. for further assistance.

Hours of operation: Monday – Friday, 5am-6pm Pacific Time (UTC-8:00)

#### Support

1-360-859-1780

1-877-486-6210 (Toll free from the US & Canada)

[support@smartrg.com](mailto:support@smartrg.com)

#### Sales

1-360-859-1780

1-877-486-6210 (Toll free from the US & Canada)

[sales@smartrg.com](mailto:sales@smartrg.com)

## SmartRG™ Residential Gateways

### Advanced Features

#### Connect-and-Surf (Automatic WAN Configuration)

The *Connect-and-Surf* feature automatically establishes a WAN connection for default configured gateways obviating the need for manual or custom configurations. The active physical layer is detected (ADSL, VDSL or GigE) and layer 3 connectivity is established using PPP authentication or DHCP.

<b>NOTE</b>	If you prefer to configure your SmartRG's WAN interface manually, connect a laptop to any of the LAN ports and follow the instructions in the " <b>Connecting a Computer to Your SmartRG™ Gateway</b> " and " <b>Use Case: Creating WAN Connections for Internet Access and Remote Management</b> " sections. Do <b>NOT</b> connect the WAN interface cable until <b>after</b> the configuration is completed.
-------------	--

#### Activation (Automatic ACS Connection Configuration)

SmartRG gateways are designed to discover their service provider specific ACS management settings without the use of custom firmware. SmartRG Inc. maintains an *activation server* that associates a device's MAC address with its service provider's ACS settings. SmartRG gateways contact the activation server to have their ACS settings modified upon initial power up (or after being reset to factory default settings).

<b>NOTE</b>	Activation server support is provided for ALL SmartRG gateways at no additional cost. SmartRG Inc. enters gateway MAC addresses into the activation server prior to shipment.
-------------	---

## Cisco™ Prime Home™ TR-069 Client

SmartRG residential gateways are equipped with the Cisco™ Prime Home™ TR-069 client. Prime Home is the premier CPE resident TR-069 client in the managed access market. It incorporates a TR-069 protocol stack, a fully developed TR-098 data model and a growing list of gateway resident applications. Prime Home enabled residential gateways ensure the highest level of TR-069 compliance providing maximum remote manageability and the greatest visibility into the connected home behind the residential gateway yielding:

- shorter integration times and lower system integration costs
- improved customer support –and-
- reduced operational expenses

## Prime Home™ Gateway Resident Advanced Applications

Prime Home™ applications serve to enhance device manageability, increase visibility into the connected home and provide revenue generating applications enabling service providers to further monetize the broadband connection. The table below compares a standard TR-069 client against the Prime Home enabled TR-069 client.







Feature	Standard TR-069 Client*	Cisco™ Prime Home™
CWMP Support, TR-098	✓	✓
WiFi and Firewall Management	✓	✓
UDM Click-Thru	✓	✓
CPE Local UI Click-Thru	✓	✓
Firmware Upgrade	✓	✓
Captive Portal	✓	✓
STUN/UDP	✓	✓
LAN Device Discovery	Partial (DHCP devices only)	✓
Connect-n-Surf (Auto WAN Config)		✓
WiFi Signal Monitor		✓
Parental Controls Time Blocking and Content Filtering		✓
WAN Bandwidth Monitor		✓
LAN Device Bandwidth Monitor		✓

**\* This list reflects the potential support based on the standard data model. Results will vary as not all TR-069 clients support the same level of functionality.**



## SmartRG™ Product Family

SmartRG residential gateways combine WAN connectivity with a firewall protected router and industry leading TR-069 remote management support. Most variants provide 802.11, Wi-Fi connectivity, as well. See the SmartRG feature details below:

	SR10	SR100	SR350N	SR350NE	SR500N	SR500NE
Models						
Broadband Connection	ADSL2+	ADSL2+	ADSL2+	Ethernet	Tri-mode: ADSL2+, VDSL, GigE	Tri-mode: ADSL2+, VDSL, GigE
10/100 Mbps LAN Ports	1	4	4	3	5	4
LAN Device Discovery	✓	✓	✓	✓	✓	✓
Managed Firewall	✓	✓	✓	✓	✓	✓
Managed WiFi			802.11N	802.11N	802.11N	802.11N
WiFi Signal Monitor			✓	✓	✓	✓
IPv6			✓	✓	✓	✓
Control Panel	✓	✓	✓	✓	✓	✓
Time Blocking			✓	✓	✓	✓
Dynamic Content Filtering			✓	✓	✓	✓
IPTV Ready			✓	✓	✓	✓

Contact SmartRG Support for detailed descriptions and management of the features listed above.

## Front Panel LEDs

The SmartRG's front panel LEDs can be useful for troubleshooting and diagnostic purposes. The typical SmartRG front panel is shown below.

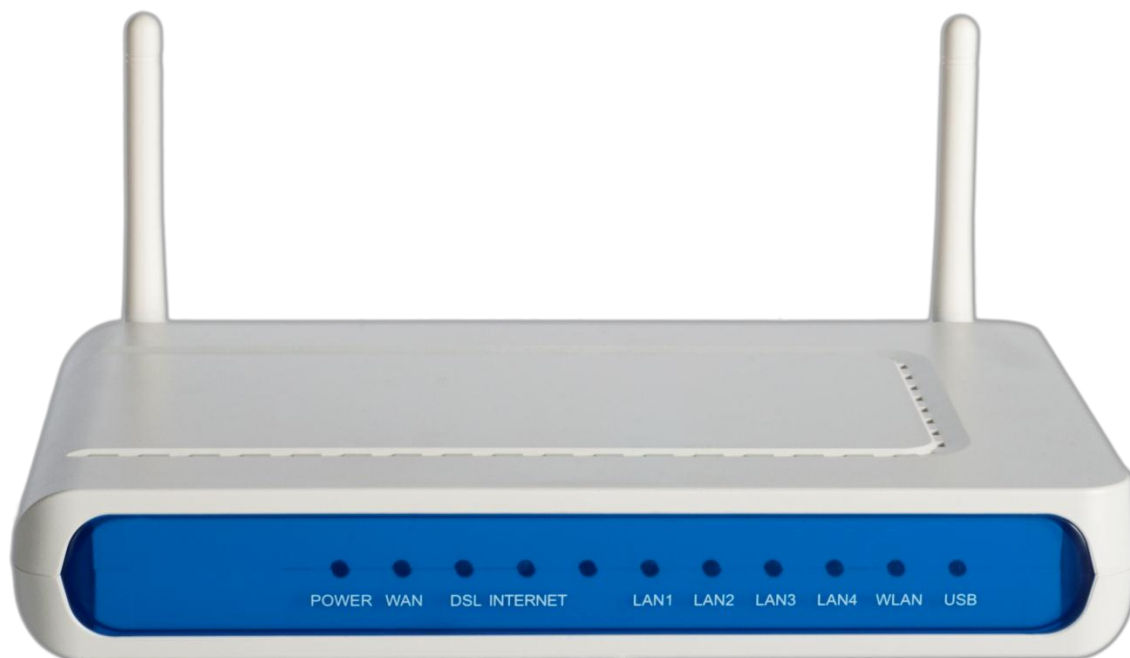

Figure 1 SmartRG Front Panel LEDs

The SmartRG front panel LEDs are defined as follows:

<b>Power</b>	<b>ON:</b> Power is on. <b>OFF:</b> Power is off.
<b>WAN (SR500N/NE)</b>	<b>ON:</b> Ethernet WAN Active. <b>OFF:</b> No link.
<b>DSL</b>	<b>ON:</b> Link established and active. <b>OFF:</b> No link. <b>Blinking:</b> Training mode.
<b>Internet</b>	<b>ON:</b> Internet connection established <b>OFF:</b> No Internet connection <b>Blinking:</b> Data transfer on WAN Internet connection
<b>LAN 1-4</b>	<b>ON:</b> LAN link established and active <b>OFF:</b> No LAN link. <b>BLINKING:</b> Data transfer on LAN port.
<b>WLAN</b>	<b>ON:</b> WLAN enabled. <b>OFF:</b> WLAN disabled. <b>Blinking:</b> data transfer currently occurring over the WiFi interface.

### Rear Panel Connectors

#### SR10

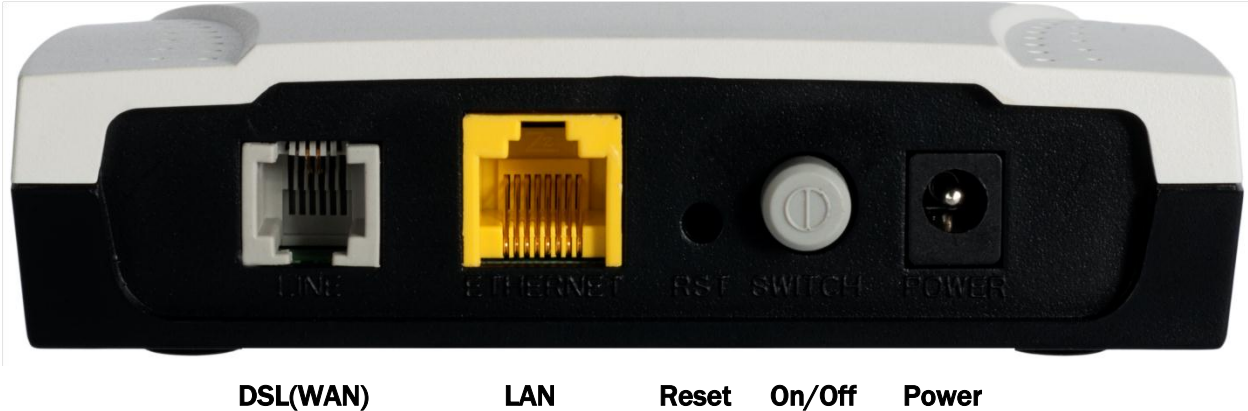

Figure 2 SR10 Rear Panel Connectors

#### SR-100

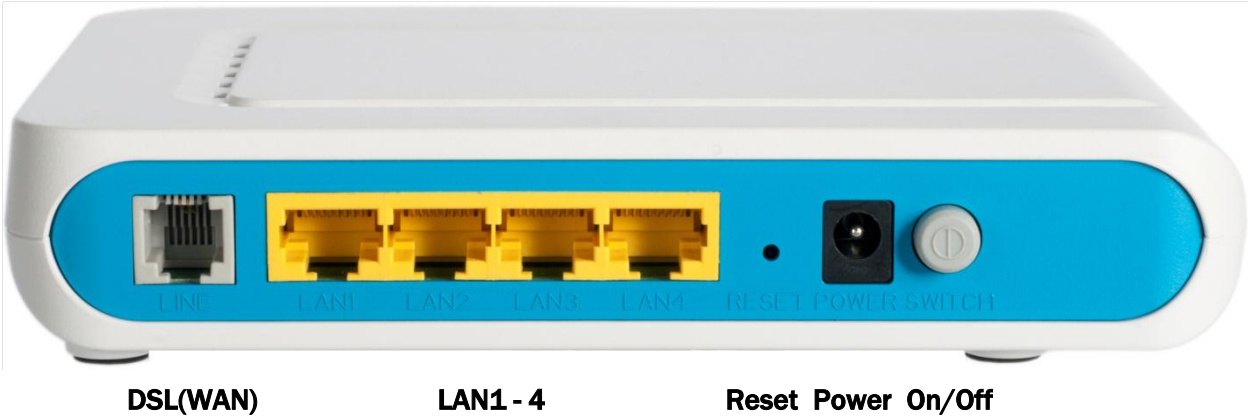

Figure 3 SR100 Rear Panel Connectors

### SR-350N



**DSL(WAN)**

**LAN1 - 4**  
**(Reset on bottom)**

**Power On/Off**

Figure 4 SR350N Rear Panel Connectors

### SR-350NE

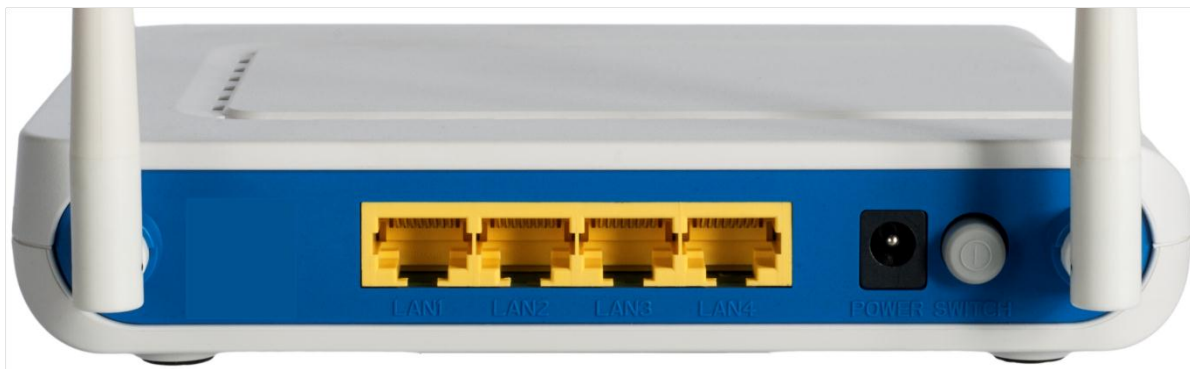

**Ethernet(WAN)**

**LAN1 - 3**  
**(Reset on bottom)**

**Power On/Off**

Figure 5 SR350NE Rear Panel Connectors

**SR-500N/SR-500NE**



**DSL(WAN) GigE(WAN) LAN1 - 4 Reset USB On/Off Power**

**Figure 6 SR500N/NE Rear Panel Connectors**

## Connecting a Computer to Your SmartRG™ Gateway

To manually configure the SmartRG access the gateway's embedded web UI:

1. attach your computer's RJ45 connection to any of the SmartRG's LAN ports (1-4)
2. configure your computer's IP interface to acquire an IP address using DHCP
3. open a browser and enter the gateway's default address <http://192.168.1.1/admin> in the address bar



Figure 7 Login Username and Password

4. Enter the default user name and password: admin/admin and click **OK** to display the Device Info page.

## Navigating Your SmartRG Gateway's Web UI

At login the Device Info page will appear. In addition to the basic identification info shown, the *Device Info* menu item can be expanded (by clicking the text) to reveal:

- WAN connection information
- WAN and LAN statistics
- Routing table entries
- ARP table entries –and-
- LAN host DHCP lease information

**SmartRG™**  
Powered by ClearAccess™

**Device Info**

Board ID:	96368MVWG
Symmetric CPU Threads:	2
Build Timestamp:	120201_2136
Software Version:	2.4.4.1_4.12L.02.A2pv6C035.d24
Bootloader (CFE) Version:	1.0.37-106.24
DSL PHY and Driver Version:	A2pv6C035.d24
Wireless Driver Version:	5.100.138.11.cpe4.12L02.6
Uptime:	18D 16H 36M 57S
System Base MAC Address:	00:25:5e:fb:27:18

This information reflects the current status of your WAN connection.

LAN IPv4 Address:	192.168.100.1
Default Gateway:	ppp0.1
Primary DNS Server:	205.171.3.25
Secondary DNS Server:	205.171.2.25
Date/Time:	Mon Jan 19 16:36:57 1970

Figure 8 Device Info Page

The remainder of the left menu bar items can be navigated in a similar fashion. Configure the following features and functions by expanding:

- **Advanced Setup** – WAN & LAN interfaces, routing, interface groupings, QoS, security, etc.
- **Wireless** – wireless access point and detailed radio settings
- **Diagnostics** – execute LAN & WAN interface diagnostics
- **Management** – backup/restore/default configurations, update device software, TR-069 ACS management settings, time zone & NTP settings and device reboot

## Configuring Your SmartRG™ - Common Use Cases

To simplify your deployment of SmartRG gateways this document is structured around specific use cases designed to illustrate meaningful, service supporting configurations like:

- Creating WAN interfaces for Internet data access and remote gateway management
- Provisioning the SmartRG for remote management via TR-069
- Setting up the LAN
- Managing wireless
- Creating IPTV service configurations (bridged and routed)
- Classifying LAN traffic and applying QoS to support IPTV and VoIP applications
- Enabling secure communications (IPSec)

Given the breadth of a SmartRG residential gateway's features and the diversity of applications, only the most common use cases are detailed here. Please contact SmartRG Support to inquire about additional use cases.

### Use Case: Creating WAN Connections for Internet Access and Remote Management

SmartRG residential gateways are commonly deployed to provide Internet access for LAN hosts such as workstations, gaming consoles, IP cameras and myriad other IP enabled devices increasingly found in the home or office. Packets routed between LAN hosts and the Internet pass through the gateway's routed WAN connection. Remote management (via TR-069) is also performed through this connection. The typical Internet access/remote management connection configuration is diagramed below.



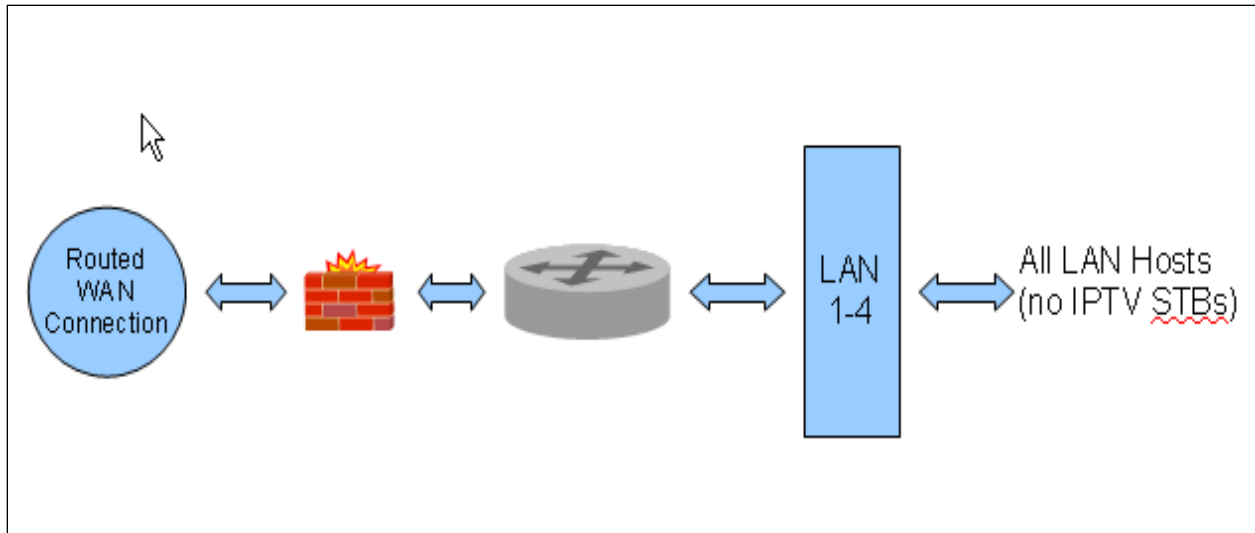

Figure 9 Internet / TR-069 Management WAN Connection

WAN connection creation is a two-step process beginning with the configuration of a layer 2 interface (Ethernet or DSL) followed by the creation of a layer 3, WAN service. Common WAN services include PPPoE, DHCP and Static IP.

### Configuring the Layer 2 Interface (Ethernet)

To configure an Ethernet layer 2 interface:

1. Select *Advanced Setup* -> *Layer2 Interface*. The default Ethernet WAN interface (eth0.5/LAN4) will be displayed.

**ETH WAN Interface Configuration**

Choose Add, or Remove to configure ETH WAN interfaces.  
Allow one ETH as layer 2 wan interface.

Interface/(Name)	Connection Mode	Remove
eth0.5/LAN4	DefaultMode	<input type="checkbox"/>

Figure 10 Ethernet Layer 2 Interface Configuration (Default)

No further configuration is necessary.

## Configuring the Layer 2 Interface (Ethernet with VLAN Tags)

In some applications it may be necessary to segment the Ethernet WAN interface into separate VLANs. A common application for a VLAN segmented WAN interface is bridged IPTV as detailed in the “Bridged IPTV Configuration” section. To configure the layer 2 Ethernet interface to support VLAN tagged traffic:

1. Select *Advanced Setup -> Layer2 Interface*. The default Ethernet WAN interface (eth0.5/LAN4) will be displayed.
2. Check the “Remove” box and click **Remove**.
3. Click **Add**.
4. Select “VLAN MUX Mode.”

**ETH WAN Configuration**  
This screen allows you to configure a ETH port .

Select a ETH port:

eth0.5/LAN4 ▼

**Select Connection Mode**

Default Mode - Single service over one connection

VLAN MUX Mode - Multiple Vlan service over one connection

MSC Mode - Multiple Service over one Connection

Back Apply/Save

Figure 11 Ethernet Layer 2 Interface Configuration (VLAN Tagged)

5. Click **Apply/Save**.

<b>NOTE</b>	802.1P (priority) and 802.1Q (VLAN tag) values will be set at the time of WAN Service creation as detailed in, “Creating the WAN Service.”
-------------	--

## Configuring the Layer 2 Interface (ADSL)

To configure an ADSL layer 2 interface:

1. Select **Advanced Setup -> Layer2 Interface** and click **Add**.

**ATM PVC Configuration**  
This screen allows you to configure an ATM PVC identifier (VPI and VCI) enable it.

VPI: [0-255]

VCI: [32-65535]

Select DSL Link Type (EoA is for PPPoE, IPoE, and Bridge.)

EoA  
 PPPoA  
 IPoA

Encapsulation Mode:

Service Category:

**Select Connection Mode**

Default Mode - Single service over one connection  
 VLAN MUX Mode - Multiple Vlan service over one connection  
 MSC Mode - Multiple Service over one Connection

**Enable Quality Of Service**

Enabling packet level QoS for a PVC improves performance for selected the number of PVCs will be reduced. Use **Advanced Setup/Quality of Se**

Enable Quality Of Service. **See Important Note**

Figure 12 ADSL Layer 2 Interface Configuration

2. Enter the PVC's identifier (VPI/VCI).
3. Select the "DSL Link Type" – Ethernet over ATM (RFC 2684) is typical.
4. Select the "Encapsulation Mode" – LLC/SNAP-BRIDGING is typical.
5. Select the "Service Category" (upstream ATM shaping) – "UBR Without PCR" (Unspecified Bit Rate Without Peak Cell Rate) is typical.
6. Select the "Connection Mode" – Choose Default Mode for non-VLAN tagged traffic. Choose VLAN MUX Mode if you intend to segment LAN traffic into separate VLAN tagged WAN services.

7. **IMPORTANT** - Check “Enable Quality of Service” if you intend to support QoS classified traffic through the WAN service.
8. Click **Apply/Save**.

<b>NOTE</b>	Enabling QoS for routed IPTV service configurations will improve channel change performance.
-------------	--

## Configuring the Layer 2 Interface (VDSL/PTM)

To configure a VDSL / PTM layer 2 interface:

1. Select **Advanced Setup -> Layer2 Interface -> PTM Interface** and click **Add**.

**PTM Configuration**  
This screen allows you to configure a PTM connection.

**Select DSL Latency**

Path0  
 Path1

**Select PTM Priority**

Normal Priority  
 High Priority (Preemption)

**Select Connection Mode**

Default Mode - Single service over one connection  
 VLAN MUX Mode - Multiple Vlan service over one connection  
 MSC Mode - Multiple Service over one Connection

**Enable Quality Of Service**

Enabling packet level QoS for this PTM interface. Use **Advanced Setup/Quality of Service** to assign priorities for the applications.

Enable Quality Of Service. **See Important Note**

Figure 13 VDSL Layer 2 Interface Configuration

2. Select the “DSL Latency” – Path0 is typical.
3. Select the “PTM Priority” – Normal Priority is typical.
4. Select the “Connection Mode” – Default Mode is typical (when VLAN segmentation is not required).
5. **IMPORTANT** - Check “Enable Quality of Service” if you intend to support QoS classified traffic through the WAN service.

6. Click **Apply/Save**.

<b>NOTE</b>	Enabling QoS for routed IPTV service configurations will improve channel change performance.
-------------	--

<b>NOTE</b>	802.1P (priority) and 802.1Q (VLAN tag) values will be set at the time of WAN Service creation as detailed in, "Creating the WAN Service."
-------------	--

## Configuring the Layer 2 Interface (VDSL/PTM with VLAN Tags)

In some applications it may be necessary to segment the PTM WAN interface into separate VLANs. A common application for a VLAN segmented WAN interface is bridged IPTV as detailed in the "Bridged IPTV Configuration" section. **To configure the layer 2 PTM interface to support VLAN tagged traffic select "VLAN MUX Mode" for "Connection Mode" in step 4 of the "Configuring the Layer 2 Interface (VDSL/PTM)" section.**

## Creating the WAN Service

WAN Services are created on top of previously created Layer 2 interfaces. To create a WAN service:

1. Select *Advanced Setup* -> *WAN Service* and click **Add**.
2. Select a previously created layer 2 interface from the drop down list and click **Next**.
3. Select the “WAN Service type” – “PPP over Ethernet” or “IP over Ethernet” are appropriate choices for routed WAN services. Bridged WAN services will be covered later in the “Bridged IPTV Configuration” section.

### WAN Service Configuration

Select WAN service type:

- PPP over Ethernet (PPPoE)
- IP over Ethernet
- Bridging

Enter Service Description:

For tagged service, enter valid 802.1P Priority and 802.1Q VLAN ID.  
For untagged service, set -1 to both 802.1P Priority and 802.1Q VLAN ID.

Enter 802.1P Priority [0-7]:   
Enter 802.1Q VLAN ID [0-4094]:

Network Protocol Selection:(IPV6 Only not supported)

Figure 14 WAN Service Configuration (With or Without VLAN Tagging Support)

<b>NOTE</b>	If VLAN tagging support is desired, set the 802.1p and 802.1q values appropriately. 802.1P: 0 is lowest priority, 7 is highest priority, -1 is unused 802.1Q: -1 indicates no VLAN tagging
-------------	--

<b>NOTE</b>	The SR-350N/NE and SR-500N/NE gateways support mixed VLAN tagged/untagged traffic on the same WAN interface. Set the untagged WAN connection’s VLAN ID to -1.
-------------	---

4. Click **Next**.

5. **For PPP WAN services** enter the “PPP Username” and “PPP Password”. If desired, enable the firewall, NAT and IGMP Proxy. Click **Next**.

**PPP Username and Password**

PPP usually requires that you have a user name and password to you.

PPP Username:

PPP Password:

PPPoE Service Name:

Authentication Method:  ▼

Dial on demand (with idle timeout timer)

PPP IP extension

Use Static IPv4 Address

Figure 15 PPP Username and Password

-OR-

6. **For I PoE WAN services** select “Obtain an IP address automatically” (DHCP) or select “Use the following Static IP address” and enter the “WAN IP Address”, “WAN Subnet Mask” and “WAN gateway IP.” Click **Next**.

**WAN IP Settings**

Enter information provided to you by your ISP to configure the WAN IP settings  
Notice: If "Obtain an IP address automatically" is chosen, DHCP will be enabled  
If "Use the following Static IP address" is chosen, enter the WAN IP address, su

Obtain an IP address automatically

Option 60 Vendor ID:

Option 61 IAID:  (8 hexadecimal digits)

Option 61 DUID:  (hexadecimal digit)

Option 125:  Disable  Enable

Use the following Static IP address:

WAN IP Address:

WAN Subnet Mask:

WAN gateway IP Address:

Figure 16 WAN IP Settings

7. If desired enable the firewall, NAT and IGMP Multicast.

**IMPORTANT**

For IPTV configurations (either bridged or routed) as detailed in, “Use Case: Setting Up Wireless Distribution System (WDS)

When deployed in a larger home or office, a single wireless access point may not be able to provide adequate Wi-Fi coverage. Wireless Distribution Systems (WDS) provides a solution for this problem. WDS combines multiple gateways to act as a single larger wireless access point allowing Wi-Fi clients to seamlessly roam all access points plus provides wired access to the entire network.

Two or more SmartRG gateways can be configured for WDS operation. The example below depicts a WDS deployment with three SmartRG gateways in a large home or office – one primary gateway in the center of the building and one remote gateway at either end of the building.



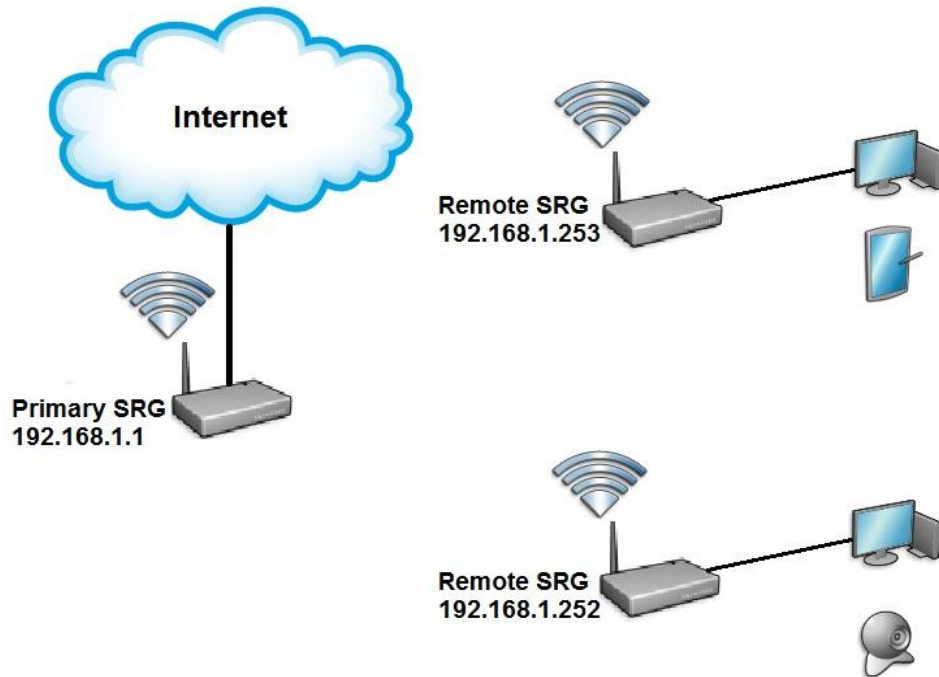

**Figure 23 Wireless Distribution System**

Configuring the SmartRG gateways for WDS operation requires the setting of **WAN**, **LAN** and **WIRELESS** parameters on all gateways included in the WDS system.

**To configure the WAN connections...**

1. On the primary SmartRG gateway: configure the routed WAN connection following the instructions in the “Use Case: Creating WAN Connections for Internet Access and Remote Management” section.
2. On the remote SmartRG gateway(s): no WAN configuration is required as the WAN connection is unused.

**To configure the LAN interfaces...**

3. On the primary SmartRG gateway:
  - a) configure the LAN interface following the instructions in the “Use Case: Setting Up the LAN” section.
  - b) ensure the DHCP Server is **ENABLED** and set the End IP Address such that enough LAN IP addresses are left for static allocation to the remote gateway(s) included in the WDS system.
4. On the remote SmartRG gateway(s):
  - a) configure the LAN interface following the instructions in the “Use Case: Setting Up the LAN” section.
  - b) ensure the LAN IPaddress(es) are assigned from the remaining IP addresses

not included in the DHCP server pool on the primary SmartRG gateway.

**IMPORTANT**

At this point your web browser session will terminate as the LAN IP address changes from 192.168.1.1 to 192.168.1.x. Reconnect your web browser to the remote gateway, referencing the new LAN IP address.

**To configure the WIRELESS interfaces...**

5. On the primary SmartRG gateway: configure the WIRELESS interface following the instructions in the “Use Case: Setting Up Wireless” section. **Do NOT select “Auto” for the Channel value.**
6. On the remote SmartRG gateway(s): configure the WIRELESS interface following the instructions in the “Use Case: Setting Up Wireless” section. **Select the same SSID, Security settings and Channel configured on the primary gateway.**
7. On the primary *and* remote SmartRG gateways:
  1. select Wireless -> Wireless Bridge and set “AP Mode” to Access Point
  2. set “Bridge Restrict” to Enabled(SCAN)
  3. click Apply/Save and wait for the page to refresh
  4. select the partner gateway (which has the same SSID as the primary gateway) by checking the box next to the SSID.
  5. Click Apply/Save

**IMPORTANT**

When more than two gateways are configured for WDS operation, the remote gateway **MUST NOT** be partnered together to avoid creating an Ethernet loop.

Use Case: Creating IPTV Service Configurations” you **MUST** enable IGMP.

**Network Address Translation Settings**

Network Address Translation (NAT) allows you to share

Enable NAT

Enable Firewall

**IGMP Multicast**

Enable IGMP Multicast

See Important Note

Enable MAC Clone:

Figure 17 WAN NAT, Firewall and IGMP Settings

8. Select the WAN interface to be used by this WAN service. Click **Next**.
9. Select “Obtain DNS info from a WAN interface” and select the desired WAN interface from the drop down list (a single WAN interface is common *unless* you are creating bridged IPTV configurations) –or- select “Use the following Static DNS IP address” and enter the IP addresses of your network’s primary and secondary DNS servers. Click **Next**.
10. Review the WAN service summary. If you are satisfied click **Apply/Save**.

## Use Case: Provisioning Your SmartRG for Remote ACS Management

<b>NOTE</b>	This step is not required for production SmartRG gateways. SmartRG maintains an “Activation Server” that associates MAC addresses with service providers’ ACS management URLs. After the SmartRG has established its WAN connection (using the Connect-and-Surf algorithm) it connects to the SmartRG Activation Server and reports its MAC. The Activation Server changes the ACS management URL to point to the service provider’s ACS.
-------------	---

To manually provision your SmartRG for management by a TR-069 enabled Automated Configuration Server:

1. Select *Management -> Management Server -> TR-069 Client*.

### TR-069 Client -- Configuration

WAN Management Protocol (TR-069) allows a Auto-Configuration Server (ACS) to perform auto-configuration, provision, collection  
Select the desired values and click "Apply/Save" to configure the TR-069 client options.

Inform  Disable  Enable

Inform Interval:

ACS URL:

ACS User Name:

ACS Password:

WAN Interface used by TR-069 client:

Connection Request Authentication

Connection Request User Name:

Connection Request Password:

Connection Request URL:

Figure 18 TR-069 Management Settings

2. Enter the following parameter values:
  - Enable “Informs”
  - Set the “Inform Interval” to 7200 seconds
  - Set the “ACS URL” (e.g. <http://myISP.acs.com/>)
  - Leave the “ACS User Name” and “ACS Password” blank
  - Enable “Connection Request Authentication”
  - Set the “Connection Request User Name and Password” to admin/admin
3. Click **Apply/Save**.

<b>NOTE</b>	Configure less and deploy more. Manage subscriber services and your entire gateway fleet with the ClearVision® management system. Contact SmartRG to start your trial today. See us at <a href="http://www.smartrg.com">www.smartrg.com</a> .
-------------	---

## Use Case: Setting Up the LAN

To configure the SmartRG's LAN interface:

1. Select *Advanced Setup* -> *LAN*

**Local Area Network (LAN) Setup**

Configure the DSL Router IP Address and Subnet Mask for LAN interface. GroupName Default ▼

IP Address: 192.168.1.1  
 Subnet Mask: 255.255.255.0

Enable IGMP Snooping  
 Standard Mode  
 Blocking Mode

See Important Note

Enable LAN side firewall

Disable DHCP Server  
 Enable DHCP Server

Start IP Address: 192.168.1.2  
 End IP Address: 192.168.1.254  
 Leased Time (hour): 24  
 Static IP Lease List: (A maximum 32 entries can be configured)

MAC Address	IP Address	Remove
<div style="display: flex; justify-content: center; gap: 10px;"> <span style="border: 1px solid gray; padding: 2px 10px;">Add Entries</span> <span style="border: 1px solid gray; padding: 2px 10px;">Remove Entries</span> </div>		

Figure 19 LAN Settings

2. Leave the "GroupName" as Default.
3. Set the LAN interface's "IP Address" and "Subnet Mask" – Default values are: 192.168.1.1/255.255.255.0.
4. **IMPORTANT** – If you intend to support IPTV (either bridged or routed), you MUST select "Enable IGMP Snooping." Select "Blocking Mode."
5. Select "Enable DHCP Server" and set the DHCP address pool's start and end IP addresses.
6. Set the DHCP "Leased Time" in hours.
7. *If you would like to create static DHCP leases for specific LAN hosts, click **Add Entries**.*

**DHCP Static IP Lease**

Enter the Mac address and Static IP address then click "Apply/Save" .

MAC Address:

IP Address:

**Figure 20 Adding DHCP Static IP Leases**

8. Enter the LAN host's "MAC Address" and the desired "IP Address."
9. Click **Apply/Save** and repeat steps 7 and 8 for all static IP LAN hosts.

## Use Case: Setting Up Wireless

To configure the SmartRG's Wireless interface:

1. Select *Wireless -> Basic*

**Wireless -- Basic**

This page allows you to configure basic features of the wireless LAN interface. You can set the wireless network name (also known as SSID) and restrict the channel set based on country. Click "Apply/Save" to configure the basic wireless options.

Enable Wireless

Hide Access Point

Clients Isolation

Disable WMM Advertise

Enable Wireless Multicast Forwarding (WMF)

SSID:

BSSID: 00:25:5E:A8:B7:F1

Country:

Max Clients:

**Wireless - Guest/Virtual Access Points:**

Enabled	SSID	Hidden	Isolate Clients	Disable WMM Advertise	Enable WMF	Max Clients	BSSID

Figure 21 Wireless - Basic Settings

2. Select "Enable Wireless."
3. Set the wireless access point's "SSID."
4. Select the "Country" from the dropdown list.
5. Click **Apply/Save**.

<b>NOTE</b>	The SmartRG provides support for 3 additional guest/virtual wireless access points.
-------------	---

6. If you would like to select a specific Wi-Fi channel (1-11), select *Wireless -> Advanced* and change the Channel setting. The default value is “Auto.”
7. Select *Wireless -> Security*

**Wireless -- Security**

This page allows you to configure security features of the wireless LAN interface.  
You may setup configuration manually  
OR  
through WiFi Protected Setup(WPS)

**WPS Setup**

Enable WPS:

**Manual Setup AP**

You can set the network authentication method, selecting data encryption, specify whether a network key is required to authenticate to this wireless network. Click "Apply/Save" when done.

Select SSID:

Network Authentication:

WPA Pre-Shared Key:  [Click here to display](#)

WPA Group Rekey Interval:

WPA Encryption:

WEP Encryption:

Figure 22 Wireless - Security Settings

8. Select the “SSID” configured in step 3 above.
9. Select the “Network Authentication” – WPA2 with a Pre-Shared Key is common
10. Enter the “WPA Pre-Shared Key.” Click the link to display the private key value.
11. Click **Apply/Save**.



## Use Case: Setting Up Wireless Distribution System (WDS)

When deployed in a larger home or office, a single wireless access point may not be able to provide adequate Wi-Fi coverage. Wireless Distribution Systems (WDS) provides a solution for this problem. WDS combines multiple gateways to act as a single larger wireless access point allowing Wi-Fi clients to seamlessly roam all access points plus provides wired access to the entire network.

Two or more SmartRG gateways can be configured for WDS operation. The example below depicts a WDS deployment with three SmartRG gateways in a large home or office – one primary gateway in the center of the building and one remote gateway at either end of the building.

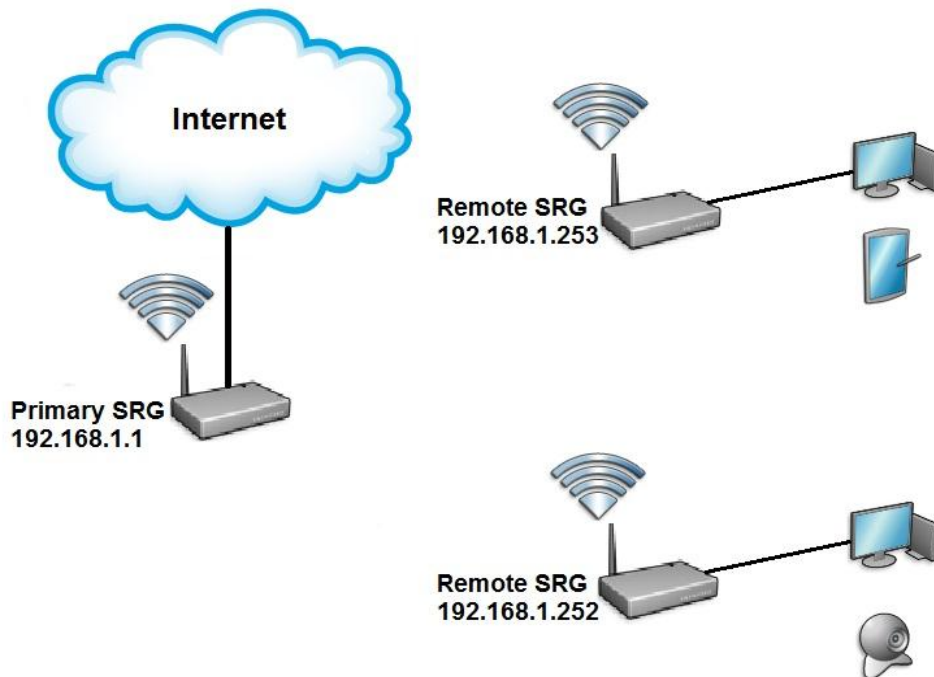

Figure 23 Wireless Distribution System

Configuring the SmartRG gateways for WDS operation requires the setting of **WAN**, **LAN** and **WIRELESS** parameters on all gateways included in the WDS system.

**To configure the WAN connections...**

3. On the primary SmartRG gateway: configure the routed WAN connection following the instructions in the “Use Case: Creating WAN Connections for Internet Access and Remote Management” section.
4. On the remote SmartRG gateway(s): no WAN configuration is required as the WAN connection is unused.

**To configure the LAN interfaces...**

5. On the primary SmartRG gateway:
  - a) configure the LAN interface following the instructions in the “Use Case: Setting Up the LAN” section.
  - b) ensure the DHCP Server is ENABLED and set the End IP Address such that enough LAN IP addresses are left for static allocation to the remote gateway(s) included in the WDS system.
6. On the remote SmartRG gateway(s):
  - a) configure the LAN interface following the instructions in the “Use Case: Setting Up the LAN” section.
  - b) ensure the LAN IPaddress(es) are assigned from the remaining IP addresses not included in the DHCP server pool on the primary SmartRG gateway.

<b>IMPORTANT</b>	At this point your web browser session will terminate as the LAN IP address has changed from 192.168.1.1 to 192.168.1.x. Reconnect your web browser to the remote SmartRG referencing the new LAN IP address.
------------------	---

**To configure the WIRELESS interfaces...**

8. On the primary SmartRG gateway: configure the WIRELESS interface following the instructions in the “Use Case: Setting Up Wireless” section. **Do NOT select “Auto” for the Channel value.**
9. On the remote SmartRG gateway(s): configure the WIRELESS interface following the instructions in the “Use Case: Setting Up Wireless” section. **Select the same SSID, Security settings and Channel configured on the primary gateway.**
10. On the primary *and* remote SmartRG gateways:
  1. select Wireless -> Wireless Bridge and set “AP Mode” to Access Point
  2. set “Bridge Restrict” to Enabled(SCAN)
  3. click Apply/Save and wait for the page to refresh
  4. select the partner gateway (which has the same SSID as the primary gateway) by checking the box next to the SSID.
  5. Click Apply/Save

<b>IMPORTANT</b>	When more than two gateways are configured for WDS operation, the remote gateways <b>MUST NOT</b> be partnered together to avoid creating an Ethernet loop.
------------------	---

## Use Case: Creating IPTV Service Configurations

The **SR350N, SR350NE, SR500N and SR500NE** SmartRG gateways are designed to meet the demands of IPTV service deployments.

Typically IPTV services have been deployed using bridged architectures with public IP addresses assigned to the IPTV Set-top-boxes (STBs) connected to the gateway's LAN ports. A typical bridged IPTV service configuration is shown below.

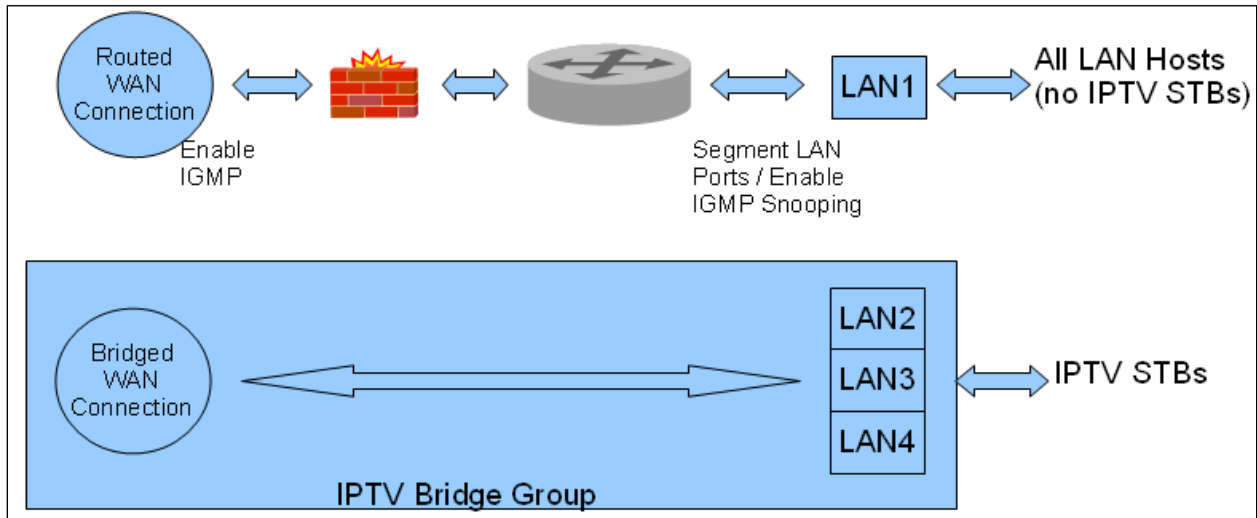

Figure 24 Bridged IPTV Configuration

Recently service providers have begun deploying routed IPTV services with STBs being assigned private LAN IP addresses by the gateway. A typical routed IPTV service configuration is shown below.

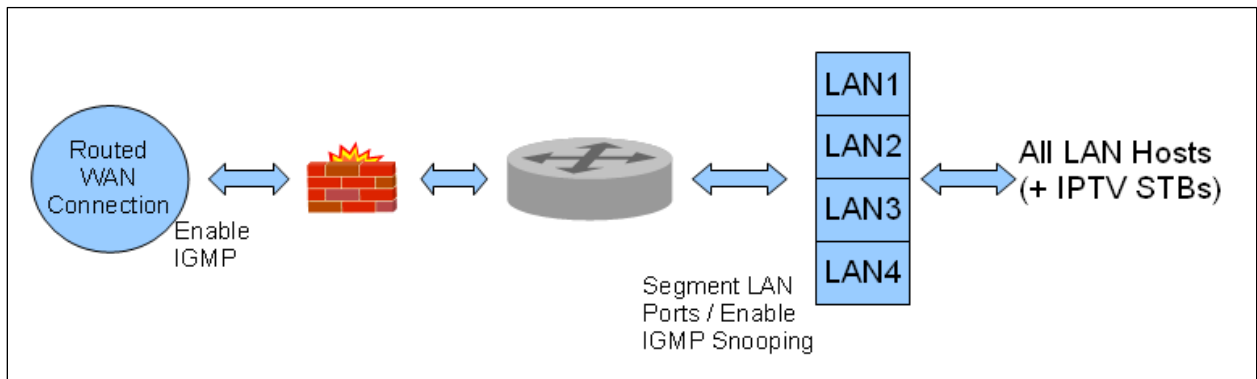

Figure 25 Routed IPTV Configuration

SmartRG gateways are designed to exceed the high bandwidth demands of either IPTV service architecture. Refer to the appropriate section below to configure the SmartRG gateway for your particular IPTV deployment architecture.

### Bridged IPTV Configuration

A bridged IPTV configuration is comprised of:

- one (or more) WAN connections
- one (or more) LAN connections –and–
- an interface grouping structure to bind all of the connections together

The more generalized bridged IPTV service configuration with multiple WAN connections is shown below.

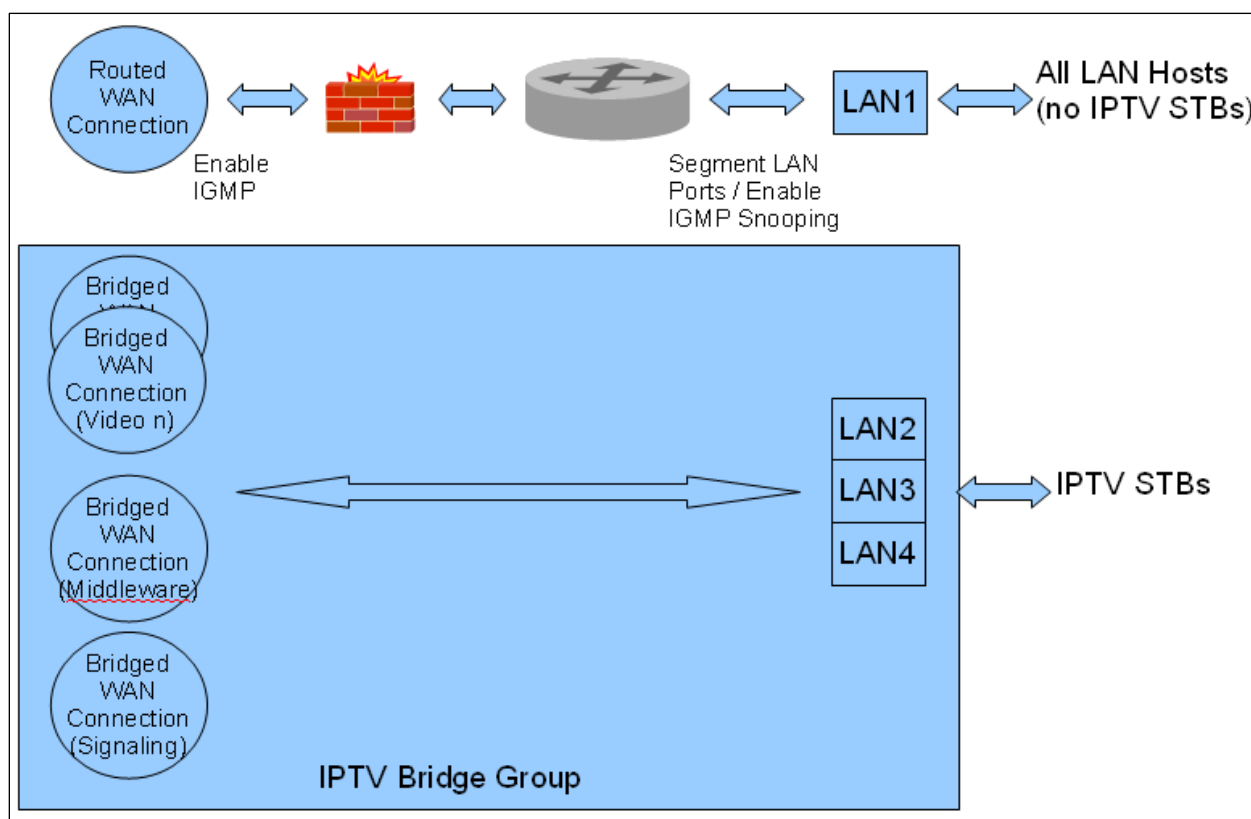

Figure 26 Multi-WAN Connection Bridged IPTV Configuration

## Creating Bridged WAN Connections

To configure the SmartRG for bridged IPTV service deployments (with one or more WAN connections) start by creating the bridged WAN connections:

1. Create a Layer 2 interface following the instructions detailed in:
  - a. “Configuring the Layer 2 Interface (Ethernet)”
  - b. “Configuring the Layer 2 Interface (ADSL)” or
  - c. “Configuring the Layer 2 Interface (VDSL/PTM)”as appropriate for your particular SmartRG (Ethernet or DSL).
2. Select *Advanced Setup -> WAN Service*.

**WAN Service Interface Configuration**

Select a layer 2 interface for this service

Note: For ATM interface, the descriptor string is (portId\_vpi\_vci)  
For PTM interface, the descriptor string is (portId\_high\_low)  
Where portId=0 --> DSL Latency PATH0  
portId=1 --> DSL Latency PATH1  
portId=4 --> DSL Latency PATH0&1  
low =0 --> Low PTM Priority not set  
low =1 --> Low PTM Priority set  
high =0 --> High PTM Priority not set  
high =1 --> High PTM Priority set

▼

**Figure 27** Selecting a Bridged WAN Service's Layer 2 Interface

3. Select the Layer 2 Interface (created in step 1 above) from the drop down list and click **Next**.

4. Select “Bridging” and click **Next**.

**WAN Service Configuration**

Select WAN service type:

PPP over Ethernet (PPPoE)

IP over Ethernet

Bridging

Enter Service Description:

Figure 28 Creating a Bridged WAN Service

5. Review the bridged WAN service summary and click **Apply/Save** if you are satisfied.
6. Repeat steps 1-5 as necessary to support your particular IPTV configuration (i.e. single or multi-WAN connection).

<b>NOTE</b>	Some DSLAMs require multiple WAN connections to support IPTV services. Contact your DSLAM vendor for IPTV configuration details.
-------------	--

<b>IMPORTANT NOTE</b>	The IGMP bridged WAN connection <b>MUST</b> be the last bridged WAN connection created.
-----------------------	---

7. Ensure “IGMP Snooping” has been enabled on the LAN as detailed in the “Use Case: Setting Up the LAN” section.
8. Check “LAN(1-4)” – (This segments the four LAN ports into separate interfaces instead of a single switched block of ports).
9. Click **Apply/Save**.

At the conclusion of step 9 your Layer 2 Interface summary (*Advanced Setup -> Layer 2 Interface*) will look similar to:

**DSL ATM Interface Configuration**

Choose Add, or Remove to configure DSL ATM interfaces.

Interface	Vpi	Vci	DSL Latency	Category	Link Type	Connection Mode	QoS	Remove
atm0	0	35	Path0	UBR	EoA	DefaultMode	Disabled	<input type="checkbox"/>
atm1	0	36	Path0	UBR	EoA	DefaultMode	Disabled	<input type="checkbox"/>
atm2	0	37	Path0	UBR	EoA	DefaultMode	Disabled	<input type="checkbox"/>
atm3	0	38	Path0	UBR	EoA	DefaultMode	Disabled	<input type="checkbox"/>
atm4	0	39	Path0	UBR	EoA	DefaultMode	Disabled	<input type="checkbox"/>
atm5	0	40	Path0	UBR	EoA	DefaultMode	Disabled	<input type="checkbox"/>

Figure 29 IPTV Layer 2 Interface Summary (Multi-WAN Bridge Group)

**NOTE** The generalized (more complex) IPTV bridge group is detailed here. The majority of DSLAMs require only a single WAN connection to support IPTV services. In that typical case:

- The “atm0” interface would provide routed WAN access for Internet services and remote management –and-
- The “atm1” interface would provide bridged WAN access for all IPTV related services (multi-cast streams, middleware server access and IGMP signaling)

Your WAN Service summary (*Advanced Setup -> WAN Service*) will look similar to:

**Wide Area Network (WAN) Service Setup**

Choose Add, or Remove to configure a WAN service over a selected interface.

Interface	Description	Type	Vlan8021p	VlanMuxId	ConnId	Igmp	NAT	Firewall	Remove
atm0	ipoe_0_0_35	IPoE	N/A	N/A	N/A	Enabled	Enabled	Enabled	<input type="checkbox"/>
atm1	br_0_0_36	Bridge	N/A	N/A	N/A	Disabled	Disabled	Disabled	<input type="checkbox"/>
atm2	br_0_0_37	Bridge	N/A	N/A	N/A	Disabled	Disabled	Disabled	<input type="checkbox"/>
atm3	br_0_0_38	Bridge	N/A	N/A	N/A	Disabled	Disabled	Disabled	<input type="checkbox"/>
atm4	br_0_0_39	Bridge	N/A	N/A	N/A	Disabled	Disabled	Disabled	<input type="checkbox"/>
atm5	br_0_0_40	Bridge	N/A	N/A	N/A	Disabled	Disabled	Disabled	<input type="checkbox"/>

Figure 30 IPTV WAN Service Summary (Multi-WAN Bridge Group)

**10. Select *Advanced Setup -> Interface Grouping*.**

**Interface Grouping -- A maximum 16 entries can be configured**

Interface Grouping supports multiple ports to PVC and bridging groups. Each with appropriate LAN and WAN interfaces using the Add button. The Remove group has IP interface.

Group Name	Remove	WAN Interface	LAN Interfaces	DHCP Vendor IDs
Default	<input type="checkbox"/>	atm1	LAN(1-4)	
		atm2	wlan0	
		atm3	wl0_Guest1	
		atm4	wl0_Guest2	
		atm5	wl0_Guest3	
		atm0		

Figure 31 Creating an IPTV Bridge Interface Group



11. Click **Add**.

**Group Name:**

<p><b>Grouped WAN Interfaces</b></p> <div style="border: 1px solid gray; height: 100px; width: 100%;"></div>	<p>-&gt;</p> <p>&lt;-</p>	<p><b>Available WAN Interfaces</b></p> <div style="border: 1px solid gray; padding: 5px; height: 100px; width: 100%;">             ipoe_0_0_35/atm0              br_0_0_36/atm1              br_0_0_37/atm2              br_0_0_38/atm3              br_0_0_39/atm4              br_0_0_40/atm5              No Interface/None           </div>
<p><b>Grouped LAN Interfaces</b></p> <div style="border: 1px solid gray; height: 100px; width: 100%;"></div>	<p>-&gt;</p> <p>&lt;-</p>	<p><b>Available LAN Interfaces</b></p> <div style="border: 1px solid gray; padding: 5px; height: 100px; width: 100%;">             LAN1              LAN2              LAN3              LAN4              wlan0              w10_Guest1              w10_Guest2              w10_Guest3           </div>

© 2009 ClearAccess. All Rights Reserved.

Figure 32 Defining an IPTV Bridge Interface Group

- 12. Enter the “Group Name.”
- 13. Highlight the bridged “WAN Interfaces” to be included in the bridge group and click <-.
- 14. Highlight the LAN Interfaces to be included in the bridge group and click <-.

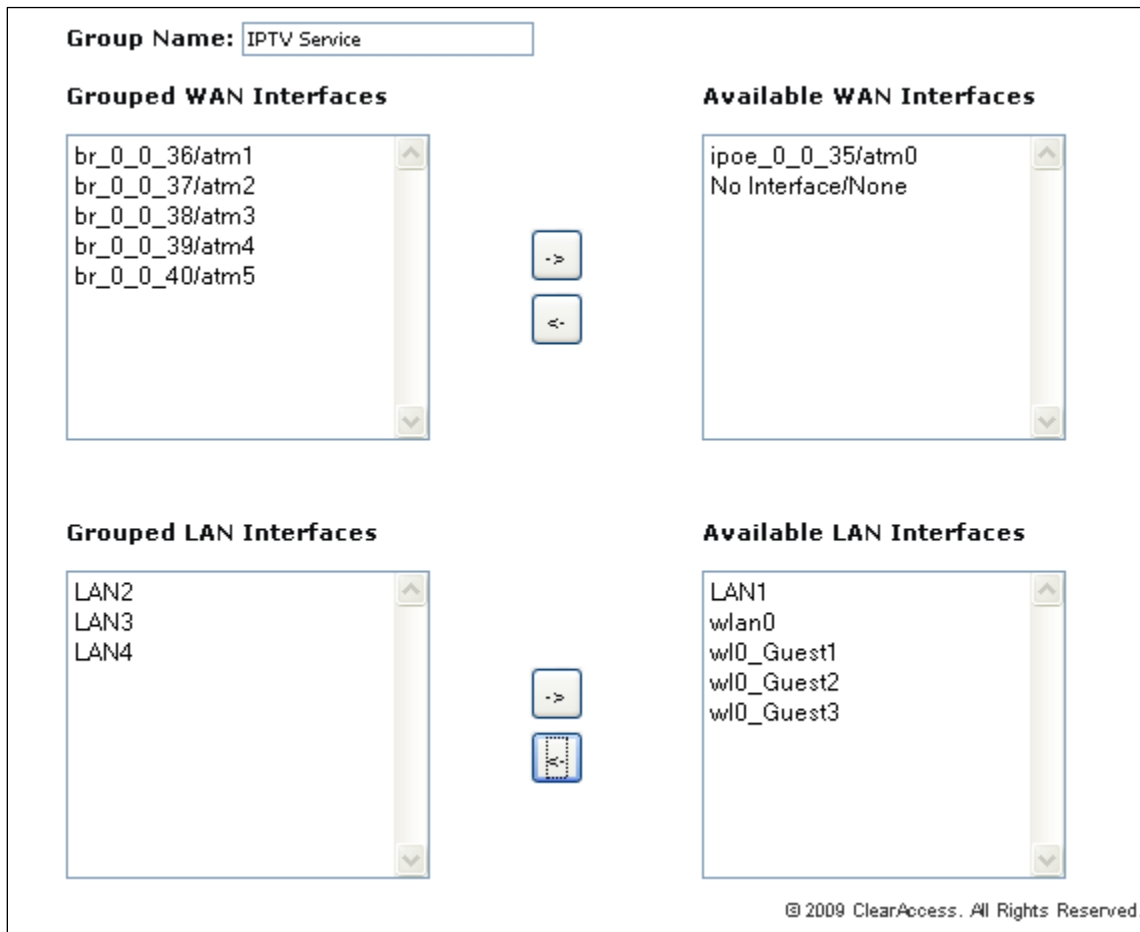

Figure 33 Typical IPTV Bridge Interface Group

- 15. Click **Apply/Save**.

## Routed IPTV Configuration (Single WAN Connection)

The common routed IPTV configuration is virtually identical to the WAN connection configuration for Internet data services with one notable exception; the addition of quality of service (QoS).

While not an absolute requirement, applying QoS to LAN traffic (with higher priority given to STBs) ensures the timely and deterministic delivery of IPTV related uni-cast requests and IGMP signaling through the gateway. This provides repeatable, shortest time possible channel changes in the presence of other LAN traffic. A typical routed IPTV service configuration with only one WAN connection is shown below.

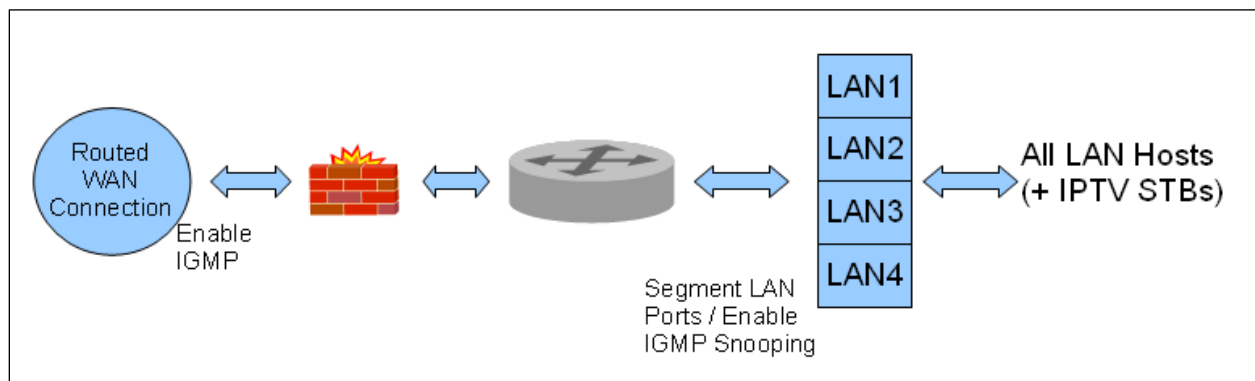

Figure 34 Routed IPTV Configuration (Single WAN Connection)

To configure the SmartRG for routed IPTV service deployments:

1. Ensure “IGMP Snooping” has been enabled on the LAN as detailed in, “Use Case: Setting Up the LAN.”
2. Create a routed WAN connection as detailed in, “Use Case: Creating WAN Connections for Internet Access and Remote Management.”
3. (Optional) Create traffic classifiers and priority queues for the various traffic categories on your LAN (e.g. Internet data, IPTV and VoIP) as detailed in, “Use Case: Applying Quality of S.”

<b>NOTE</b>	<p>The SmartRG family of gateways employs “Differentiated Services” (RFC 2474) to provide IP traffic QoS. When configuring QoS for various traffic categories the following Differentiated Services Code Point (DSCP) values are suggested:</p> <ul style="list-style-type: none"> <li>• Internet data – Best Effort (DSCP 0)</li> <li>• IPTV – AF21 (DSCP 18)</li> <li>• VoIP – Expedited Forwarding (DSCP 46)</li> </ul>
-------------	--

<b>NOTE</b>	Some STBs pre-mark their IP traffic making classification a relatively straightforward task for the gateway. If your STB pre-marks its traffic, passing the DSCP mark through unchanged is suggested.
-------------	---

### Routed IPTV Configuration (Multiple WAN Connections)

It is also possible to create routed IPTV configurations with multiple WAN connections. The notable difference to typical routed IPTV configurations is the addition of one or more bridged WAN connections to support multiple multicast IPTV streams. Again QoS is suggested. A typical multi-WAN connection, routed IPTV service configuration is shown below.

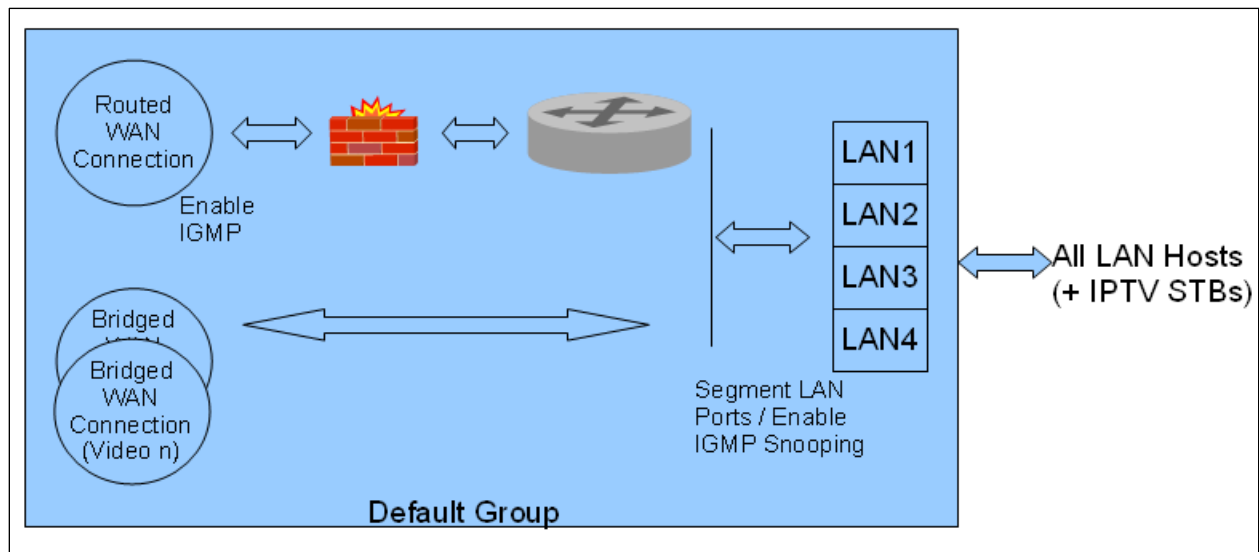

Figure 35 Routed IPTV Configuration (Multiple WAN Connections)

To configure the SmartRG for multi-WAN connection, routed IPTV service deployments, follow the single WAN connection, routed IPTV configuration instructions above –plus- add bridged WAN connections using the instructions detailed in, “Creating Bridged WAN Connections.”

## Use Case: Applying Quality of Service (QoS) to VoIP and IPTV LAN Traffic

When deploying time critical services such as VoIP and IPTV comingled with common data services, it becomes necessary to prioritize the time critical, upstream LAN traffic over common data traffic (e.g Internet data and file transfers). Time critical traffic commonly includes SIP signaling (VoIP call setup/teardown) and IGMP signaling (IPTV channel change). The SmartRG line of gateways prioritizes time critical traffic using the “Differentiated Services Code Point” field in the IP header as defined by RFC 2474.

**NOTE** The residential gateway plays no part in the prioritization of downstream traffic.

Traffic generated by LAN hosts such as VoIP phones, IPTV STBs and PCs is identified by “classifiers” and placed into prioritization “queues.” Queues are emptied through the routed WAN connection based on queue priority. Classifiers can identify traffic based on a number of criteria including: source/destination MAC address, source/destination IP address, protocol, DSCP mark, etc. This section describes a *typical* QoS configuration to prioritized upstream VoIP and IPTV traffic.

A *typical* VoIP/IPTV/data QoS configuration is shown below:

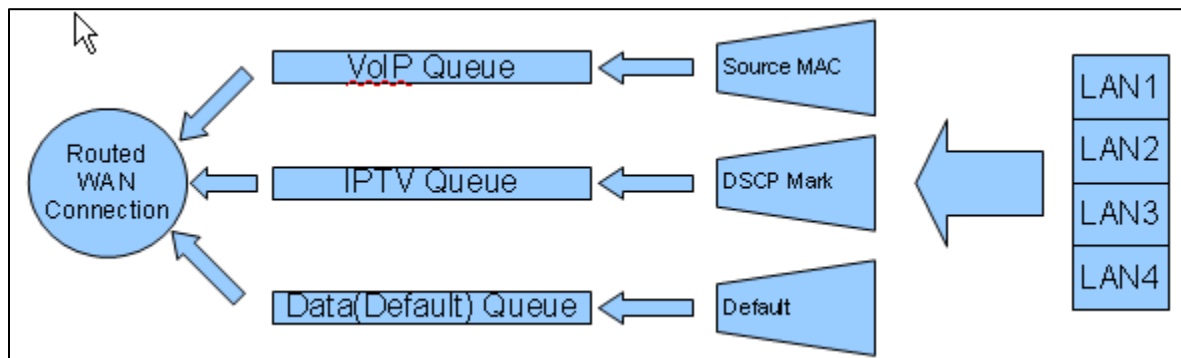

Figure 36 Typical QoS configuration to support VoIP and IPTV services

VoIP traffic is identified by its source MAC/Mask (VoIP user agent OUI) and IPTV traffic is identified by the DSCP mark in its IP header. All remaining traffic is placed in the data (default) queue.

**NOTE** Mediaroom based IPTV STBs place the **DSCP18** mark on all upstream traffic.

The QoS configuration process is comprised of three main steps:

- Enable QoS on the routed WAN connection and enable QoS processing
- Create traffic queues to prioritize the different types of traffic –and–
- Create traffic classifiers to identify the different types of traffic

To configure the SmartRG's QoS feature:

1. Ensure the layer 2 WAN interface “Enable Quality of Service” check box is checked as detailed in the Layer 2 Interface configuration sections.
2. Select *Advanced Setup -> Quality of Service -> QoS Config*

**QoS -- Queue Management Configuration**

If Enable QoS checkbox is selected, choose a default DSCP mark

**Note: If Enable QoS checkbox is not selected, all QoS will be disabled**

**Note: The default DSCP mark is used to mark all egress packets**

Enable QoS

Select Default DSCP Mark No Change(-1) ▼

Figure 37 Enable the SmartRG's QoS Processing

3. Check “Enable QoS”, set the “Default DSCP Mark” to “No Change(-1)” and click **Apply/Save**.
4. Create the VoIP queue by selecting *Advanced Setup -> Quality of Service -> QoS Queue Config* and click **Add**.

**QoS -- Configuration**

The screen allows you to configure a QoS queue by the classifier to place ingress packets appropriate interface/precedence pair, resulting in a maximum bandwidth. Click 'Apply/Save' to save and activate the queue

Name: VoIP

Enable: Enable ▼

Interface: atm0(0\_0\_35) ▼

Precedence: 1 ▼

DSL Latency: Path0 ▼

Figure 38 QoS: VoIP Queue Configuration

- Name, enable and select the WAN interface to be fed by this queue.

<b>IMPORTANT NOTE</b>	Select the routed WAN interface created in the “Creating the WAN Service” section.
-----------------------	--

- Select a “Precedence” of 1.

<b>NOTE</b>	Lower values of “Precedence” indicate HIGHER priority.
-------------	--

- Leave the “DSL Latency” value set to Path0 and Click **Apply/Save**.
- Create the IPTV queue by selecting *Advanced Setup* -> *Quality of Service* -> *QoS Queue Config* and click **Add**.

**QoS -- Configuration**

The screen allows you to configure a QoS queue by the classifier to place ingress packets appropriate interface/precedence pair, resulting in a maximum. Click 'Apply/Save' to save and activate the queue.

Name:

Enable:  ▼

Interface:  ▼

Precedence:  ▼

DSL Latency:  ▼

Figure 39 QoS: IPTV Queue Configuration

- Name, enable and select the WAN interface to be fed by this queue.

<b>IMPORTANT NOTE</b>	Again, select the routed WAN interface created in the “Creating the WAN Service” section.
-----------------------	---

- Select a “Precedence” of 2.

<b>NOTE</b>	IPTV traffic should be of LOWER priority (HIGHER Precedence value) than VoIP traffic.
-------------	---

11. Leave the “DSL Latency” value set to Path0 and Click **Apply/Save**.

**NOTE** The default data queue depicted in the QoS architecture diagram above does not need to be specifically created.

12. Enable the newly created queues by selecting *Advanced Setup -> Quality of Service -> QoS Queue Config*, check the “Enable” boxes for the new queues and click **Enable**. The correct queue configuration for VoIP and IPTV services should look like:

**QoS -- Queue Config Setup -- A maximum 24 entries can be configured.**

If you disable the WMM Advertise function in the Wireless Basic Setup page, classification related **The QoS function has been disabled. Queues will not take effect.**

Name	Key	Interface	Precedence	DSL Latency	PTM Priority	Enable	Remove
WMM Voice Priority	1	wl0	1			Enabled	
WMM Voice Priority	2	wl0	2			Enabled	
WMM Video Priority	3	wl0	3			Enabled	
WMM Video Priority	4	wl0	4			Enabled	
WMM Best Effort	5	wl0	5			Enabled	
WMM Background	6	wl0	6			Enabled	
WMM Background	7	wl0	7			Enabled	
WMM Best Effort	8	wl0	8			Enabled	
VoIP	33	atm0	1	Path0		<input checked="" type="checkbox"/>	<input type="checkbox"/>
IPTV	34	atm0	2	Path0		<input checked="" type="checkbox"/>	<input type="checkbox"/>

Figure 40 QoS Queue Enable



**13. Create the VoIP traffic classifier by selecting *Advanced Setup -> Quality of Service -> QoS Classification* and click **Add**.**

**Add Network Traffic Class Rule**

The screen creates a traffic class rule to classify the upstream traffic, assign queue name and at least one condition below. All of the specified conditions in this classification rule must be met for traffic to be classified.

Traffic Class Name:

Rule Order:  ▼

Rule Status:  ▼

**Specify Classification Criteria**  
A blank criterion indicates it is not used for classification.

Class Interface:

Ether Type:  ▼

Source MAC Address:

Source MAC Mask:

Destination MAC Address:

Destination MAC Mask:

▼

Source Subnet Mask:

Destination IP Address:

Destination Subnet Mask:

Differentiated Service Code Point (DSCP) Check:

Protocol:

**Specify Classification Results**  
Must select a classification queue. A blank mark or tag value means no change.

Assign Classification Queue:  ▼

Mark Differentiated Service Code Point (DSCP):

Mark 802.1p priority:

Tag VLAN ID [0-4094]:

**Figure 41 QoS VoIP Classifier Configuration**

**14. Set the Name, Rule Order, and enable the classifier rule.**

**IMPORTANT NOTE** If you create the classifier rules in priority order (VoIP then IPTV), you may leave the “Rule Order” set to “Last.” Each successive classifier rule created will become the last one checked in the traffic identification process.

- 15. Select an “Ether Type” of IP (0x800).**
- 16. Enter the source MAC and Mask values in 01:02:03:04:05:06/FF:FF:FF:00:00:00 format.**
- 17. Assign the Classification Queue (identified by WAN interface&Precedence&Path).**
- 18. Click **Apply/Save**.**

19. Create the IPTV traffic classifier by selecting *Advanced Setup -> Quality of Service -> QoS Classification* and click **Add**.

**Add Network Traffic Class Rule**

The screen creates a traffic class rule to classify the upstream traffic, assign queue name and at least one condition below. All of the specified conditions in this classification are checked in the traffic identification process.

Traffic Class Name:

Rule Order:

Rule Status:

**Specify Classification Criteria**  
A blank criterion indicates it is not used for classification.

Class Interface:

Ether Type:

Source MAC Address:

Source MAC Mask:

Destination MAC Address:

Destination MAC Mask:

Source Subnet Mask:

Destination IP Address:

Destination Subnet Mask:

Differentiated Service Code Point (DSCP) Check:

Protocol:

**Specify Classification Results**  
Must select a classification queue. A blank mark or tag value means no change.

Assign Classification Queue:

Mark Differentiated Service Code Point (DSCP):

Mark 802.1p priority:

Tag VLAN ID [0-4094]:

Figure 42 QoS IPTV Classifier Configuration

20. Set the Name, Rule Order, and enable the classifier rule.

**IMPORTANT NOTE** If you create the classifier rules in priority order (VoIP then IPTV), you may leave the “Rule Order” set to “Last.” Each successive classifier rule created will become the last one checked in the traffic identification process.

21. Select an “Ether Type” of IP (0x800).

22. Enter the “Differentiated Service Code Point (DSCP) Check” value.

**NOTE** AF21 (DSCP18) is common for Mediaroom STBs.

23. Assign the Classification Queue (identified by WAN interface&Precedence&Path).
24. Click **Apply/Save**. The correct classifier configuration for VoIP and IPTV services should look like:

**QoS -- Classification Setup -- A maximum 32 entries can be configured.**

Choose Add or Remove to configure network traffic classes.  
 If you disable the WMM Advertise function in the Wireless Basic Setup page, classification related to wireless will not have any effect.

CLASSIFICATION CRITERIA														CLASSIFICATION RESULTS				
Class Name	Order	Class Intf	Ether Type	SrcMAC/ Mask	DstMAC/ Mask	SrcIP/ Mask	DstIP/ Mask	Proto	Src Port	Dst Port	DSCP Check	802.1P Check	Queue Key	DSCP Mark	802.1P Mark	VlanID Tag	Enable	Remove
VoIP	1		IP	01:02:03:04:05:06/FF:FF:FF:00:00:00									33				<input checked="" type="checkbox"/>	<input type="checkbox"/>
IPTV	2		IP								AF21		34	default			<input checked="" type="checkbox"/>	<input type="checkbox"/>

Figure 43 QoS VoIP and IPTV Classifier Config

The QoS configuration is now complete.

## Managing Your SmartRG™ Gateway

### Save, Restore or Default Configurations

To save the existing gateway configuration to your hard drive:

1. Select *Management -> Settings -> Backup*.
2. Click **Backup Settings**.

To restore a previously saved gateway configuration:

1. Select *Management -> Settings -> Update*.
2. Browse to find the saved config file on your hard drive (e.g. mySmartRGConfig.conf)
3. Click **Update Settings**.

To reset the gateway to factory default settings:

1. Select *Management -> Settings -> Restore Defaults*.
2. Click **Restore Default Settings**.

### Update Software

To update the gateway's software:

1. Select *Management -> Update Software*.
2. Browse to find the new gateway software on your hard drive (ex: CA\_D2.3.0.2010\_04\_12\_09\_07\_16\_SR300N\_fs\_kernel)
3. Click **Update Software**.

<b>NOTE</b>	The software update process takes approximately 2 minutes to complete. Do NOT power cycle the gateway until the software update process has completed.
-------------	--

## Configure Time Settings

To set the gateway's time zone and NTP server settings:

1. Select *Management -> Internet Time*.
2. Select your time zone from the drop down list.
3. (Optional) Select the first, second ... NTP servers from the drop down lists. (A custom NTP server can be configured by selecting "Other" from the drop down list and entering the custom URL.)

**Time settings**

This page allows you to change the modem's time configuration.

Automatically synchronize with Internet time servers

First NTP time server:

Second NTP time server:

Third NTP time server:

Fourth NTP time server:

Fifth NTP time server:

Time zone offset:

Figure 44 Time Zone and NTP Server Settings

4. Click **Apply/Save**.

## Configure Access Controls (HTTP, Telnet, SSH, etc.)

To enable/disable gateway management services such as HTTP, Telnet and SSH:

1. Select *Management -> Access Control -> Services*.

Services	LAN	WAN
FTP	<input checked="" type="checkbox"/> Enable	<input type="checkbox"/> Enable
HTTP	<input checked="" type="checkbox"/> Enable	<input type="checkbox"/> Enable
ICMP	Enable	<input type="checkbox"/> Enable
SSH	<input checked="" type="checkbox"/> Enable	<input type="checkbox"/> Enable
TELNET	<input checked="" type="checkbox"/> Enable	<input type="checkbox"/> Enable
TFTP	<input checked="" type="checkbox"/> Enable	<input type="checkbox"/> Enable

Figure 45 Enabling/Disabling HTTP, Telnet, SSH ... Access

2. Enable/disable LAN and/or WAN access to the various management services as desired .
3. Click **Save/Apply**.

<b>NOTE</b>	For security reasons it is strongly recommended that WAN access to all services be disabled accept during deployment or when troubleshooting.
-------------	---

## Configure User Logins

SmartRG gateways support the following user roles:

- admin – unrestricted access by a PC connected to a LAN port
- support – unrestricted access by an ISP technician connected through the managed WAN interface

To change user passwords:

1. Select *Management* -> *Access Control* -> *Services*.
2. Enter the username (admin/support).
3. Enter the old password and the new password.
4. Click **Apply/Save**.

## Reset the Gateway

### Hardware Reset

Reset the gateway by inserting a paper clip or similar tool into the reset switch hole located on either the rear or the bottom of the gateway (depending upon model). Press the switch briefly to reset the device.

### Hardware Reset (to Factory Default Settings)

To reset the gateway to its factory default settings press the reset switch for 4 to 5 seconds starting at power up. After releasing the reset switch the gateway will continue booting with a factory default configuration.

<b>IMPORTANT</b>	<p>Pressing the reset switch for more than 6 seconds causes the SmartRG gateway to reset into its <i>boot image</i> rendering the gateway non-functional. This condition can be detected by:</p> <ul style="list-style-type: none"><li>• the inability to access the SmartRG gateway's user interface using your web browser –and-</li><li>• the inability to properly establish a WAN connection</li></ul> <p>To correct this condition simply cycle power on the gateway.</p>
------------------	---

### Software Reset

To reset the gateway using the SmartRG gateway's web UI:

1. Select *Management* -> *Reboot*.
2. Click **Reboot**.

<b>NOTE</b>	Software resets, hardware resets and power cycles behave identically.
-------------	---



# Troubleshooting

## Accessing System Logs

To configure the System Log for use during troubleshooting efforts:

1. Select *Management* -> *System Log*.
2. Click **Configure System Log**.

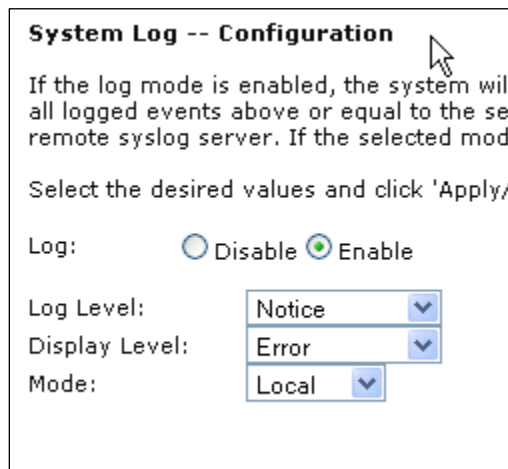

Figure 46 Configuring the System Log for Use In Troubleshooting

3. Select the “Log Level” from the drop down list. “Debugging” provides the greatest level of log detail.
4. Select the “Display Level” from the drop down list. “Debugging” provides the greatest level of display detail.
5. Click **Apply/Save**.

<b>NOTE</b>	Gateway logs can be sent to a remote server for storage. To configure the remote “Mode” select “Remote” from the drop down list and configure the remote server’s IP address and UDP port number.
-------------	---

## Executing Diagnostics

To execute the SmartRG's interface diagnostics:

1. Select *Diagnostics*.

## Technical Support

For technical support contact:

### Support

Monday – Friday, 5am-6pm Pacific Time (UTC-8:00)

1-360-859-1780

1-877-486-6210 (Toll free from the US & Canada)

[support@smartrg.com](mailto:support@smartrg.com)