

ZXDSL-531B ADSL Router

User's Manual

Rev:01

2003/05/27

No part of this publication may be reproduced in any form by any means without the prior written permission. Other trademarks or brand names mentioned herein are trademarks or registered trademarks of their respective companies.

2003/05/27

Rev:01

Safety Notes

For Installation

- Use only the type of power source indicated on the marking labels.
- Use only the power adapter supplied with the product.
- Do not overload wall outlet or extension cords as this may increase the risk of electric shock or fire. If the power cord is frayed, replace it with a new one.
- Proper ventilation is necessary to prevent the product overheating. Do not block or cover the slots and openings on the device, which are intended for ventilation and proper operation. It is recommended to mount the product with a stack.
- Do not place the product near any source of heat or expose it to direct sunlight.
- Do not expose the product to moisture. Never spill any liquid on the product.
- Do not attempt to connect with any computer accessory or electronic product without instructions from qualified service personnel. This may result in risk of electronic shock or fire.
- Do not place this product on an unstable stand or table.

For Using

- Power off and unplug this product from the wall outlet when it is not in use or before cleaning. Pay attention to the temperature of the power adapter. The temperature might be high.
- After powering off the product, power on the product at least 15 seconds later.
- Do not block the ventilating openings of this product.
- When the product is expected to be not in use for a period of time, unplug the power cord of the product to prevent it from the damage of storm or sudden increases in rating.

For Service

Do not attempt to disassemble or open covers of this unit by yourself. Nor should you attempt to service the product yourself, which may void the user's authority to operate it. Contact qualified service personnel under the following conditions:

- If the power cord or plug is damaged or frayed.
- If liquid has been spilled into the product.
- If the product has been exposed to rain or water.
- If the product does not operate normally when the operating instructions are followed.
- If the product has been dropped or the cabinet has been damaged.
- If the product exhibits a distinct change in performance.

Warning

- This equipment must be installed and operated in accordance with provided instructions and a minimum 20 cm spacing must be provided between computer mounted antenna and person's body (excluding extremities of hands, wrist and feet) during wireless modes of operation.
- This device complies with Part 15 of the FCC Rules. Operation is subject to the following two conditions: (1) this device may not cause harmful interference, and (2) this device must accept any interference received, including interference that may cause undesired operation.

Caution

- Any changes or modifications not expressly approved by the party responsible for compliance could void the authority to operate equipment.

Contents

Before You Use	vi
Features	vi
System Requirements	vii
Unpacking	vii
Subscription for ADSL Service	viii
Chapter 1: Overview	1
Physical Outlook	1
<i>Front Panel</i>	1
<i>Rear Panel</i>	2
Chapter 2: Installation	3
Choosing a place for the ADSL Router	3
Connecting the ADSL Router	3
Chapter 3: Connection Mode	5
Bridge Mode	6
Router Mode	7
MER Mode	9
PPPoA + NAT Mode	10
PPPoE + NAT Mode	11
PPPoE Relay	12
Multiple PVCs Mode	13
Chapter 4: Configuration	15
Setting TCP/IP on Client PC	15
<i>For Windows 98</i>	15
<i>For Windows ME</i>	18
<i>For Windows NT</i>	20
<i>For Windows 2000</i>	23
<i>For Windows XP</i>	25
Configure PC to get IP address from DHCP	26
<i>For Windows 98</i>	26
<i>For Windows ME</i>	27
<i>For Windows NT</i>	27
<i>For Windows 2000</i>	27
<i>For Windows XP</i>	28
Renew IP Address on Client PC	29
<i>For Windows 98</i>	29
<i>For Windows ME</i>	29
<i>For Windows NT</i>	30
<i>For Windows 2000</i>	30
<i>For Windows XP</i>	30
Chapter 5: Web Configuration	32

Using Web-Based Manager	32
<i>Outline of Web Manager</i>	32
<i>To Have the New Settings Take Effect</i>	33
Quick start.....	33
System	34
<i>Device Information</i>	34
<i>Administration</i>	34
<i>Backup Configuration</i>	36
<i>Save Configuration</i>	36
<i>Upgrade Software</i>	36
<i>Reset Router</i>	37
Status.....	38
<i>DSL Connection</i>	38
<i>WAN Connection</i>	38
<i>Traffic Counter</i>	39
<i>Routing Table</i>	39
<i>DHCP Table</i>	39
<i>Wireless Client</i>	39
Configuration	40
<i>DSL Configuration</i>	40
<i>LAN Configuration</i>	40
<i>WLAN Configuration</i>	44
<i>WAN Configuration</i>	46
<i>IP Route</i>	48
<i>DNS</i>	49
<i>Security</i>	51
<i>Virtual Server</i>	56
<i>IGMP Proxy</i>	58
<i>UPnP (Optional)</i>	59
Chapter 6: Troubleshooting	62
Problems with LAN.....	62
Problems with WAN	62
Problems with Upgrading	63
Chapter 7: Glossary	66
Appendix: Specifications.....	68
<i>Software</i>	68
<i>Hardware</i>	69

Before You Use

Thank you for choosing the Asymmetric Digital Subscriber Line (ADSL) Router. With the asymmetric technology, this device runs over standard copper phone lines and provides a downstream rate at up to 8 Mbps and upstream rate at up to 1 Mbps. In addition, ADSL allows you to have both voice and data services in use simultaneously all over one phone line.

Equipped with Ethernet LAN interface, this ADSL Router can be connected to a LAN or a single Ethernet-equipped PC. A built-in dynamic host configuration protocol (DHCP) server automatically assigns IP addresses to PCs on the LAN, and with Network Address Translation (NAT) these PCs can communicate with the outside world with only one public IP. This ADSL Router provides an ideal Internet access solution for the corporate environment, the small office and the home user.

Features

ADSL Compliance

For Annex A ADSL Router

- ANSI T1.413 Issue 2
- ITU G.992.1 Annex A (G.dmt)
- ITU G.992.2 Annex A (G.lite)
- ITU G.994.1 (G.hs)

ATM Features

- Compliant to ATM Forum UNI 3.1 / 4.0 Permanent Virtual Circuits (PVCs)
- Support up to 8 AAL5 Virtual Circuit Channels (VCCs) for UBR, CBR, VBR-rt, and VBR-nrt with traffic shaping
- TR-037 Auto PVC ^{*1}(auto-provisioning)
- RFC1483 (RFC2684) LLC Encapsulation and VC Multiplexing over AAL5
- RFC2364 Point-to-Point Protocol (PPP) over AAL5
- RFC2225 Classical IP and ARP over ATM
- RFC2516 PPP over Ethernet: support Relay (Transparent Forwarding) and Client functions
- OAM F4/F5 End-to-End/Segment Loopback Cells

Bridging Features

- Supports self-learning bridge specified in IEEE 802.1D Transparent Bridging
- Supports up to 4000 learning MAC addresses
- Transparent bridging among 10/100 Mb Ethernet and 802.11b LAN interfaces

Routing Features

- UPnP IGD ^{*2} (Internet Gateway Device) with NAT traversal capability support
- NAT (Network Address Translation) / PAT (Port Address Translation) let multiple users on the LAN to access the internet for the cost of only one IP address and enjoy various multimedia applications.
- ALGs (Application Level Gateways): such as NetMeeting, FTP, Quick Time, mIRC, Real Player, CuSeeMe, etc.
- Multiple Virtual Servers (e.g., Web, FTP, Mail servers) can be setup on user's local network.
- Static routes, RFC1058 RIPv1, RFC1723 RIPv2.
- DNS Relay and DNS Server ^{*3}

- ARP Proxy

Security Features

- PAP (RFC1334), CHAP (RFC1994) for PPP session
- Firewall support IP packets filtering based on IP address/Port number/Protocol type and TCP code field flags
- Intrusion Detection provides protection from a number of attacks (such as SYN/FIN/RST Flood, Smurf, WinNuke, Echo Scan, Xmas Tree Scan, etc)
- WEP (Wired Equivalent Privacy) encryption uses RC4 with 64/128 bit key length (for wireless ADSL router only)

Wireless LAN Features

- Fully compatible to IEEE 802.11b standard and allow operating range up to 300 meters (open space) and 100 meters (indoor).
- The Direct Sequence Spread Spectrum (DSSS) technology is exploited.
- Seamless roaming within the 802.11 and 802.11b wireless LAN infrastructure
- Low power consumption via efficient power management

Configuration and Management

- User-friendly embedded web configuration interface with password protection
- Remote management accesses control
- Telnet session for local or remote management
- HTTP firmware upgrades via web browser GUI directly
- Distribute IP addresses to end users via DHCP server provided by ADSL router
- SNMPv1/v2c agent with MIB-II, PPP MIB, ADSL Line MIB.

Note:

- *1 This is optional. TR-037 Autopvc provisioning can be provided on demand.
 - *2 This is optional. UPnP IGD and NAT Traversal function can be provided on demand.
 - *3 This is optional. DNS server can be provided on demand.
-

System Requirements

For using this, you have to make sure you have the following that installed on the clients:

For Ethernet Clients

- ◆ Operating System must be Windows98/2000/NT/ME/XP
- ◆ 10/100 Base-T NIC
- ◆ 10/100 Base-T(UTP) network cable
- ◆ A Hub

For Wireless Clients

- ◆ Operating System must be Windows98/2000/NT/ME/XP
- ◆ Wireless card installed
- ◆ Wireless card driver

Unpacking

Check the contents of the package against the pack contents checklist below. If any of the items is missing, then contact the dealer from whom the equipment was purchased.

- ADSL Router

- Power Adapter and Cord
- RJ-11 ADSL Line Cable
- RJ-45 Ethernet Cable
- Quick Start Guide

Depending on the service type your vendor offers, you may be provide with the devices below:

- Splitter (for G.dmt version)
- Micro filter (for G.lite version)

Subscription for ADSL Service

To use the ADSL Router, you have to subscribe for ADSL service from your broadband service provider. According to the service type you subscribe, you will get various IP addresses:

Dynamic IP: If you apply for dial-up connection, you will be given an Internet account with username and password. You will get a dynamic IP by dialing up to your ISP.

Static IP address: If you apply for full-time connectivity, you may get either one static IP address or a range of IP addresses from your ISP. The number of IP addresses varies according to different ADSL service provider.

Chapter 1: Overview

Physical Outlook

Front Panel

The following illustration shows the front panel of the ADSL Router:

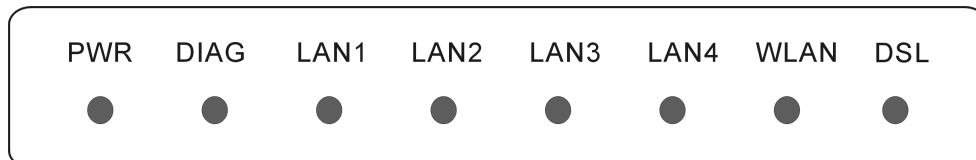

LED Indicators

The ADSL Router is equipped with LEDs on the front panel as described in the table below (from left to right):

LED	Color	Status	Description
PWR	Green	Unlit	Power off.
		Solid	Power on.
DIAG	Green	Unlit	Power off or initial self-test of the unit is OK.
		Blinking	When software downloading or updating operation parameters located in FLASH memory is in progress.
		Solid	Initial self-test failure or programming FLASH memory failure.
LAN1 to LAN4	Green	Unlit	Power off or no Ethernet carrier is present.
		Blinking	Ethernet carrier is present and user data is going through Ethernet port.
		Solid	Ethernet carrier is present.
WLAN	Green	Unlit	Power off or no radio signal (WLAN card is not present or fails to function).
		Blinking	Traffic is going through Wireless LAN interface.
		Solid	Wireless LAN interface ready to work.
DSL	Green	Unlit	Power off or ADSL line connection is handshaking or training is in progress.
		Blinking	User data is going through ADSL port.
		Solid	ADSL line connection is OK.

Rear Panel

The following figure illustrates the rear panel of your ADSL Router.

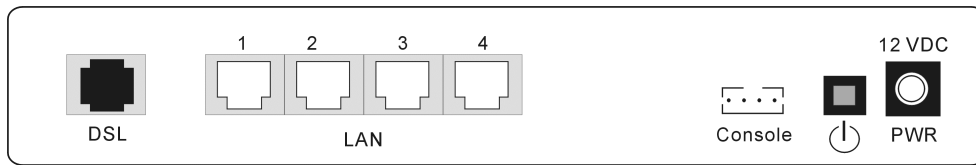

DSL: RJ-11 connector

LAN: Ethernet 10/100 Base-T auto-sensing

Reset: Reset to factory settings

Console: Console connector

⏻: Power switch

12VDC: Power connector

Note: The Router incorporates a four-port switch for connection to your local Ethernet network. The Ethernet ports are marked LOCAL, and are capable of operation at either 10 Mbps (10 BASE-T) or 100 Mbps (100 BASE-Tx).

Chapter 2: Installation

Choosing a place for the ADSL Router

1. Place the ADSL Router close to ADSL wall outlet and power outlet for the cable to reach it easily.
2. Avoid placing the device in places where people may walk on the cables. Also keep it away from direct sunshine or heat sources.
3. Place the device on a flat and stable stand.

Connecting the ADSL Router

Follow the steps below to connect the related devices.

1. Remove the end of the phone line from your phone connector and plug it onto the “LINE” port of the POTS Splitter. Use another phone line to connect your phone and splitter. Plug this phone line onto the “PHONE” port of the ADSL splitter, and plug the other end of the line onto your phone.

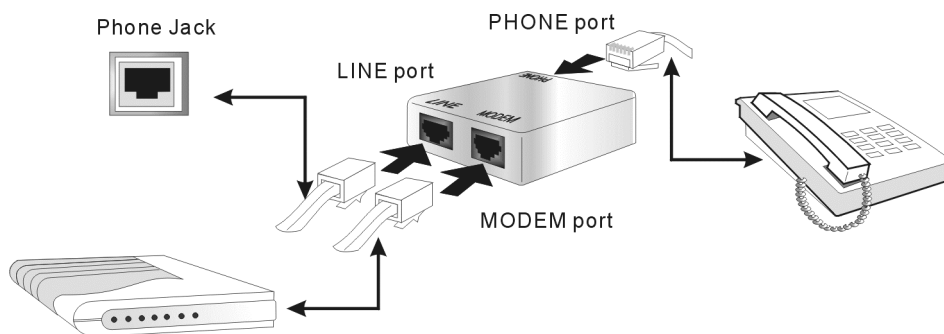

2. Use the line to connect the ADSL splitter (MODEM port) and router's DSL port.
3. Please attach one end of the Ethernet cable with RJ-45 connector to the LAN port of your ADSL Router.

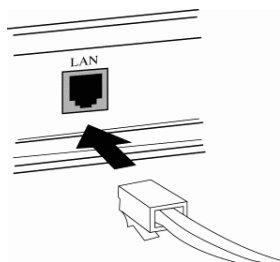

4. Connect the other end of the cable to the Ethernet port of the client PC.

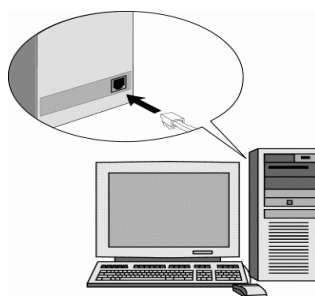

5. If you want to connect to a hub for used by many devices, please connect the other end to the uplink port of the hub.

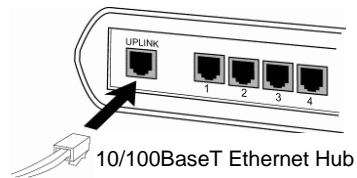

6. Connect the supplied power adapter to the **PWR** port of your ADSL Router, and plug the other end to a power outlet.

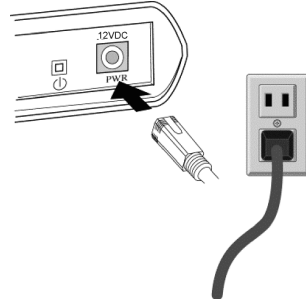

7. Turn on the power switch.

Note:

For Full Rate (G.dmt) standard, a POTS Splitter is necessary on subscriber's premise to keep the telephone and ADSL signals separated, giving them the capability to provide simultaneous Internet access and telephone service on the same line. To connect a POTS Splitter:

1. Connect the port **Phone** to your telephone.
 2. Connect the port **Modem** to your ADSL Router.
 3. Connect the port **Line** to the ADSL wall jack.
-

Chapter 3: Connection Mode

Prior to configuring the ADSL Router, you must decide whether to configure the ADSL Router as a bridge or as a router. This chapter presents some deployment examples for your reference. Each mode includes its general configure procedures. For more detailed information about web configuration, refer to "Web Configuration".

- Bridge Mode
- Router Mode
- MER Mode
- PPPoA+ NAT Mode
- PPPoE + NAT Mode
- Multiple PVCs Mode

For making sure that you can connect the ADSL to your computer well and get into Internet successfully, please make sure the following first.

1. Make sure you have installed a network interface card onto your computer.
2. Make sure the connection between the ADSL and your computer is OK.
3. Check to see the TCP/IP protocol and set the IP address as "Auto Get IP Address".

When you are sure all above is Ok, you can open the Browser and type in "192.168.100.100" and start to do the web configuration with different connection modes.

This chapter is going to introduce the function of each connection mode and tell you the basic configuring steps that you have to do. If you did not follow the configuring steps for using these connection modes, you might get some connection problems and cannot connect to Internet well.

Bridge Mode

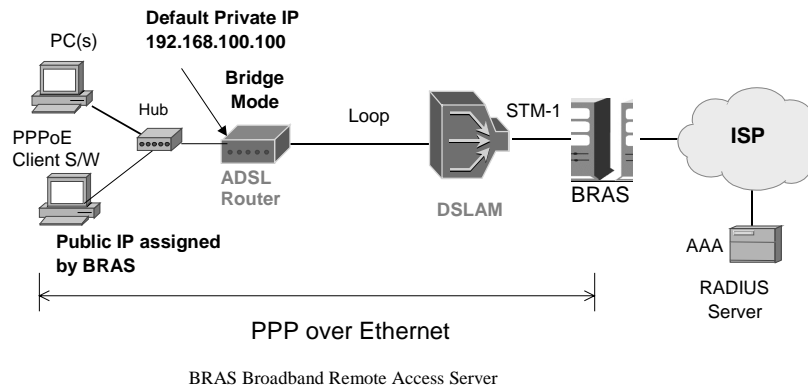

Description:

In this example, the ADSL Router acts as a bridge which bridging PC IP address from LAN to WAN. PC IP address can be a static public address that is pre-assigned by ISP or a dynamic public address that is assigned by ISP DHCP server, or can be got from PPPoE software.

Therefore, it does not require a public IP address. It only has a default private IP address (192.168.100.100) for management purpose.

Configuration:

1. Choose a client PC and set the IP as 192.168.100.x (x is between 2 and 254) and the gateway as 192.168.100.100.
2. Start up your browser and type **192.168.100.100** as the address to enter the web-based manager.
3. Go to **Configuration > WAN Configuration > Create a New PVC** and select the Data Mode –**RFC1483 Bridged**. Then click **Next** button.
4. Enter the VPI/VCI values provided by your ISP and select the encapsulation type as **LLC/SNAP** or **VC MUX**. Then click **Apply**.
5. Save the configuration from **System > Save Configuration** and **System > Restart** to restart your router for initiating these settings.

Router Mode

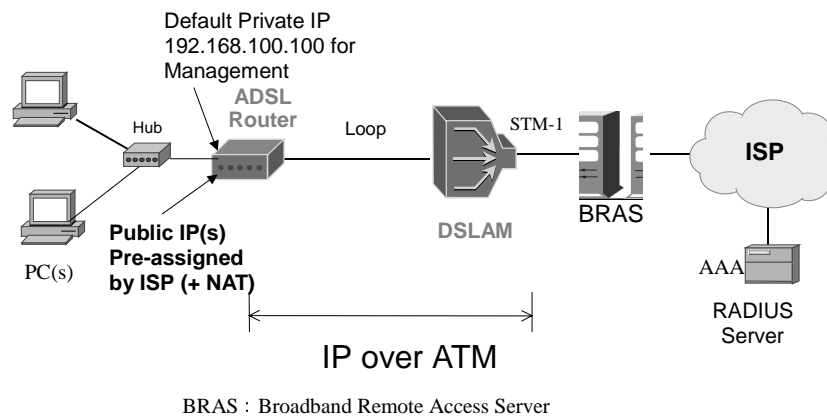

Description:

In this deployment environment, we make up a private IP network of 192.168.100.100. NAT function is enabled (on ADSL Router or use another NAT box connected to hub) to support multiple clients to access the Router and some public servers (WWW, FTP).

If you apply for multiple IP addresses from your ISP, you can assign these public IP addresses to the ADSL Router and public server, e.g., Web or FTP server. Typically the first IP is network address, the second is used as router IP address and the last one is subnet broadcasting. Other remaining IP addresses can be assigned to PCs on the LAN.

For example: You are given the IP addresses 10.251.2.0 ~ 10.251.2.7. Then:

- 10.251.2.0 is network IP address
- 10.251.2.1 is assigned to router IP address.
- 10.251.2.7 is subnet broadcasting
- 10.251.2.2~10.251.2.6 can be assigned to public servers on the LAN.

Configuration:

1. Start up your browser and type **192.168.100.100** as the address to enter this ADSL web-based manager.
2. Go to **Configuration > WAN Configuration > Create a new PVC**. and select the Data Mode **-RFC1483 Routed**. Then click **Next** button.
3. Enter the VPI/VCI values provided by your ISP and select the encapsulation type as **LLC/SNAP** or **VC MUX**. Then click **Apply**.
4. Set IP configuration for Local WAN IP Address. Choose **Specify an IP Address** item. Please set as the following example,
IP Address: **10.3.80.105**(should be the one that you get from ISP)
Subnet Mask: **255.255.255.248**(should be the one that you get from ISP)
Check on **Enable NAT on this interface** and click **Apply**.
5. Go to **Configuration > LAN Configuration** and set as the following
Primary IP: **192.168.100.100**, Subnet Mask: 255.255.255.0
Secondary IP: **10.3.80.105**, Subnet Mask: 255.255.255.248
(should be the one that you get from ISP)
Then click **Apply**.
6. Go to **Configuration > IP Route** and click **Create a New Route** to add a new route.
Destination Address: leave default
Netmask: leave default
Forward packets to: **Interface**
Then click **Apply**.
7. Go to **Configuration > DNS** and enable **DNS Relay** setting and click **Next**. On the DNS Relay web page, enter the DNS Server IP address, for example **168.95.1.1** (you should get this value from your ISP).
8. Save the configuration from **System > Save Configuration** and **System > Restart** to restart your router for initiating these settings.

9. Then you have set the web configuration successfully. And you can surf on the Internet.

Note:

If you have multiple PCs on the LAN, you may enable DHCP function on the private or public IP address. The ADSL Router implements a built-in DHCP server, which assigns IP addresses to the clients PCs on the LAN.

MER Mode

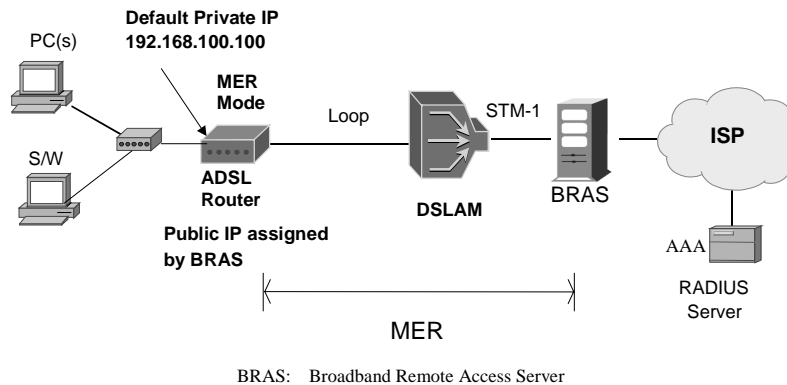

Description:

In this deployment environment, we make up a private IP network of 192.168.100.100. NAT function is enabled to support multiple clients to access Internet.

In this example, the ADSL Router acts as NAT device which translate a private IP address into a public address. Therefore multiple users can share with one public IP address to access Internet through this router. The public address can be a static public address that is pre-assigned by ISP or a dynamic public address that is assigned by ISP DHCP server.

Configuration:

1. Start up your browser and type **192.168.100.100** as the address to enter this ADSL web-based manager.
2. Go to **Configuration > WAN Configuration > Create a new PVC**. and select the Data Mode –**RFC1483 MER**. Then click **Next** button.
3. Enter the VPI/VCI values provided by your ISP and select the encapsulation type as **LLC/SNAP** or **VC MUX**. Then click **Apply**.
4. Set IP configuration for Local WAN IP Address. Choose **Specify an IP Address** item. Please set as the following example,
IP Address: **10.3.86.105** (should be the one that you get from ISP)
Subnet Mask: **255.255.255.0** (should be the one that you get from ISP)
5. Go to **Configuration > IP Route** and click **Create a new route** to add a new route. Configure the settings as the following example,
Destination Address: leave default
Netmask: leave default
Forward packets to: **Gateway Address: 10.3.86.1** (you should get this value from your ISP)
Then click **Apply**.
6. Go to **Configuration > DNS** and enable **DNS Relay** setting and click **Next**. On the DNS Relay web page, enter the DNS Server IP address, for example **168.95.1.1** (you should get this value from your ISP).
7. Save the configuration from **System > Save Configuration** and **System > Restart** to restart your router for initiating these settings.
8. Then you have set the web configuration successfully. And you can surf on the Internet.

PPPoA + NAT Mode

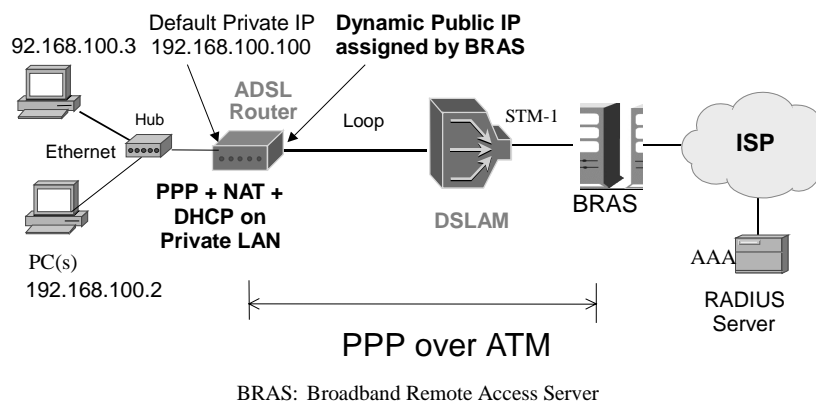

Description:

In this deployment environment, the PPPoA session is between the ADSL WAN interface and BRAS. The ADSL Router gets a public IP address from BRAS when connecting to DSLAM. The multiple client PCs will get private IP address from the DHCP server enabled on private LAN. The enabled NAT mechanism will translate the IP information for clients to access the Internet.

Configuration:

1. Start up your browser and type **192.168.100.100** as the address to enter this ADSL web-based manager.
2. Go to **Configuration > WAN Configuration > Create a new PVC** and select the Data Mode – **PPPoA**. Then click **Next** button.
3. Enter the VPI/VCI values provided by your ISP and select the encapsulation type as **LLC/SNAP** or **VC MUX**.
4. Fill in the **User Name** and **Password** (you should get from ISP). Check on **Enable NAT on this interface** and click **Apply**.
5. Go to **Configuration > DNS** and enable **DNS Relay** setting and click **Next**. On the DNS Relay web page, enter the DNS Server IP address, for example **168.95.1.1** (you should get this value from your ISP).
6. Save the configuration by execute **System > Save** and **System > Restart** to restart your router for initiating these settings.

PPPoE + NAT Mode

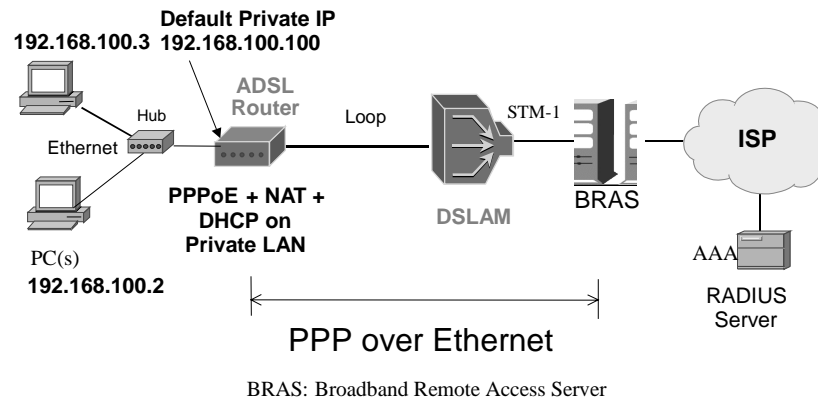

Description:

In this deployment environment, the PPPoE session is between the ADSL WAN interface and BRAS. The ADSL Router gets a public IP address from BRAS when connecting to DSLAM. The multiple client PCs will get private IP address from the DHCP server enabled on private LAN. The enabled NAT mechanism will translate the IP information for clients to access the Internet.

Configuration:

1. Start up your browser and type **192.168.100.100** as the address to enter this ADSL web-based manager.
2. Go to **Configuration > WAN Configuration > Create a new PVC** and select the Data Mode – **PPPoE**. Then click **Next** button.
3. Enter the VPI/VCI values provided by your ISP and select the encapsulation type as **LLC/SNAP** or **VC MUX**.
4. Fill in the **User Name** and **Password** (you should get from ISP). Check on **Enable NAT on this interface** and click **Apply**.
5. Go to **Configuration > DNS** and enable **DNS Relay** setting and click **Next**. On the DNS Relay web page, enter the DNS Server IP address, for example **168.95.1.1** (you should get this value from your ISP).
6. Save the configuration by execute **System > Save** and **System > Restart** to restart your router for initiating these settings.

PPPoE Relay

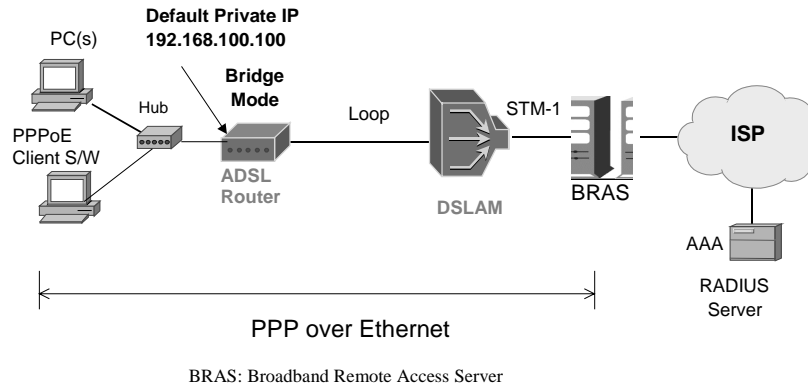

Description:

In this example, the ADSL Router acts as a bridge which bridging PC IP address from LAN to WAN. Client PCs on the LAN should be equipped with PPPoE software to get public IP address from BRAS.

That is to say, the router does not require a public IP address. It only has a default private IP address (192.168.100.100) for management purpose.

Configuration:

1. Choose a client PC and set the IP as 192.168.100.x (x is between 2 and 254) and the gateway as 192.168.100.100. Or enter the IP address that came from the ISP DHCP server of the Router.
2. Start up your browser and type **192.168.100.100** as the address to enter the web-based manager.
3. Go to **Configuration > WAN Configuration > Create a New PVC** and select the Data Mode –**RFC1483 Bridged**. Then click **Next** button.
4. Enter the VPI/VCI values provided by your ISP and select the encapsulation type as **LLC/SNAP** or **VC MUX**. Then click **Apply**.
5. Save the configuration from **System > Save Configuration** and **System > Restart** to restart your router for initiating these settings.
6. Run Windows PPPoE client application. Fill in the **User Name** and **Password** (you should get from ISP).



7. Click **Connect**.

Multiple PVCs Mode

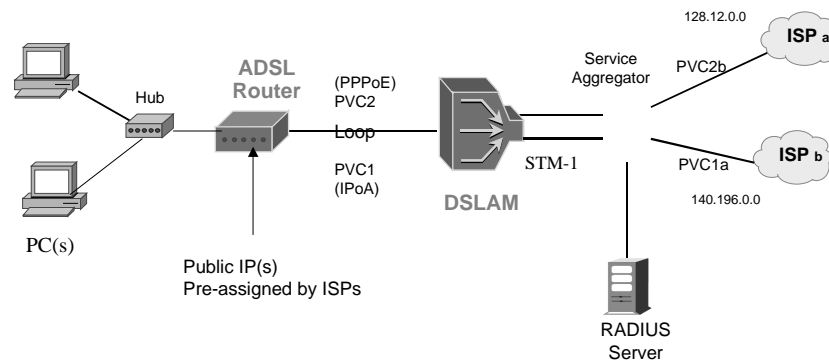

Description:

As this ADSL Router supports multiple PVCs in the ADSL loop, you are allowed to configure several logical channels in one physical loop. You can use mixed encapsulation types by applying them to different PVCs. When the system starts up, it will connect to CO site through the PVCs according to the sequence they are created. Therefore the default route will be the last PVC you created. You can also modify the default route manually from the **IPRoute** page.

The traffic from CPE side will be sent to different PVCs according to the routing rules.

Configuration:

1. Start up your browser and type 192.168.100.100 as the address to enter this ADSL web-based manager.
2. Create the first PVC (e.g. PVC1) using the **RFC1483** data mode. Refer to the section of “Router Mode” for details.
3. Create the second PVC (e.g. PVC2) using the **PPPoE** data mode. Refer to the section of “PPPoE + NAT Mode” for details.
4. Save the configuration by execute **System > Save** and **System > Restart** to restart your router for initiating these settings.

Chapter 4: Configuration

In order to access the Internet through the router, each host on your network must install/setup TCP/IP. Please follow the steps below for select a network adapter.

Setting TCP/IP on Client PC

To access the ADSL Router via Ethernet, the host computer must meet the following requirements:

- With Ethernet network interface.
- Must have TCP/IP installed.
- Set client PC with obtain an IP address automatically or set fix IP address.
- With a web browser installed: Internet Explorer 5.x or later.

The ADSL Router is configured with the **default IP address of 192.168.100.100** and subnet mask of **255.255.255.0**. As the DHCP server is **Enable** by default, The DHCP clients should be able to access the ADSL Router. Or you could assign an IP address to the host PC first for initial configuration.

You also can manage the ADSL Router through a web browser-based manager: **ADSL ROUTER CONTROL PANEL**. The ADSL Router manager uses the HTTP protocol via a web browser to allow you to set up and manage the device.

To configure the device via web browser, at least one properly-configured PC must be connected to the network (either connected directly or through an external hub/switch to the LAN port of the device).

If TCP/IP is not already installed, follow the steps below for installation.

For Windows 98

1. Click on the **Start** menu, point to **Settings** and click on **Control Panel**.

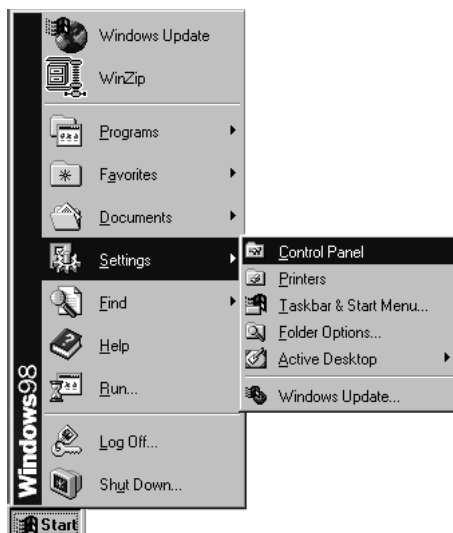

2. Double-click the **Network** icon.



3. The **Network** window appears. On the **Configuration** tab, check out the list of installed network components.

Option 1: If you have **no** TCP/IP protocol, click **Add**.

Option 2: If you have TCP/IP protocol, go to Step 6.

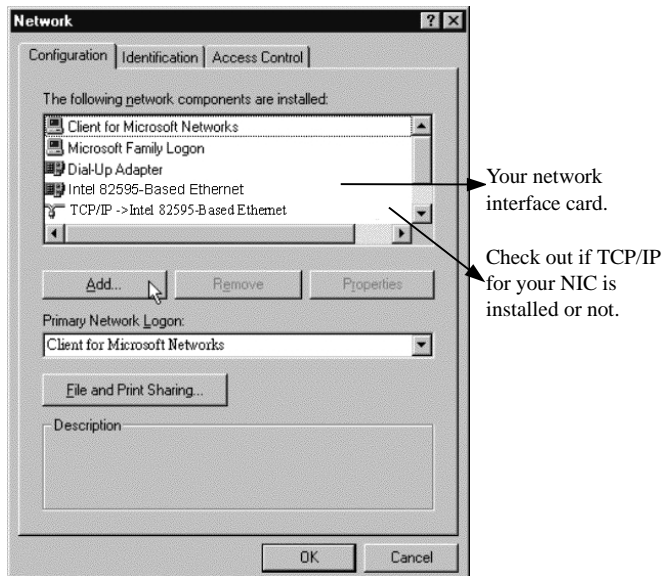

4. Highlight **Protocol** and click **Add**.

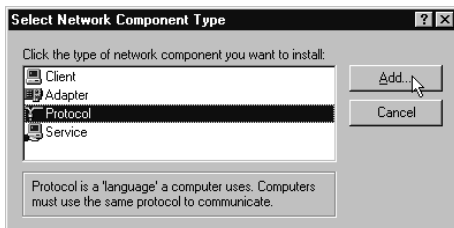

5. On the left side of the windows, highlight **Microsoft** and then select **TCP/IP** on the right side. Then click **OK**.

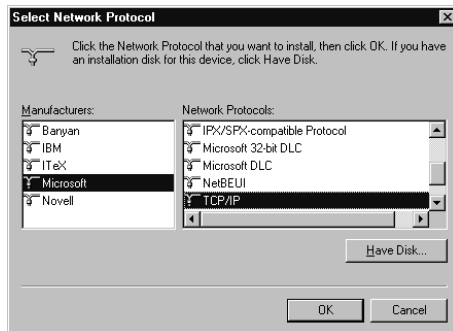

6. When returning to **Network** window, highlight **TCP/IP** protocol for your NIC and click **Properties**.

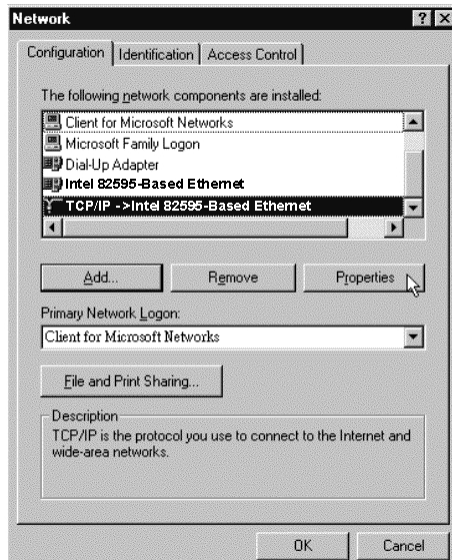

7. On **IP Address** tab:
 Enable **Specify an IP address** option. Enter the **IP Address**: 192.168.10000.x (x is between 2 and 254) and **Subnet Mask**: 255.255.255.0 as in figure below. On **Gateway** tab: Add a gateway IP address: 192.168.100.100.

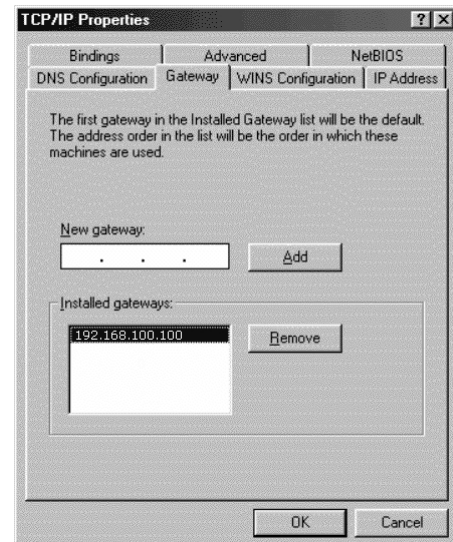
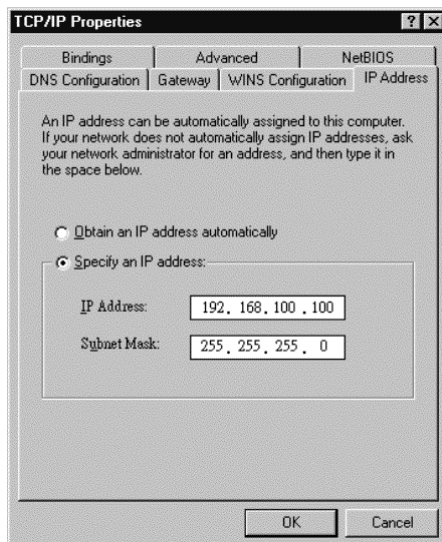

8. When returning to **Network** window, click **OK**.

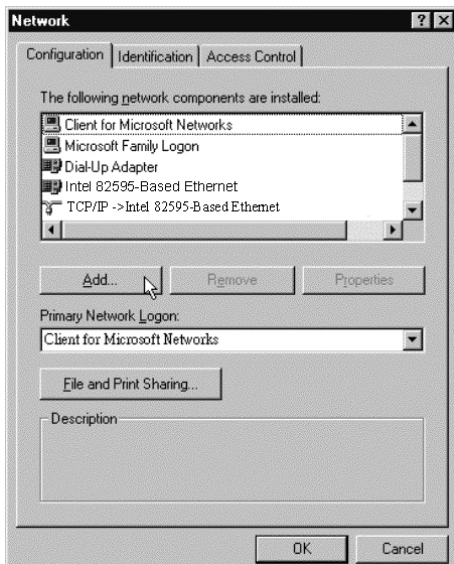

9. Wait for Windows copying files.

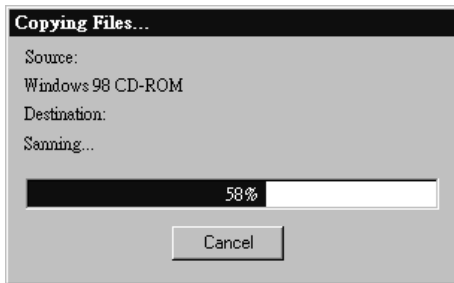

10. When prompted with **System Settings Change** dialog box, click **Yes** to restart your computer.

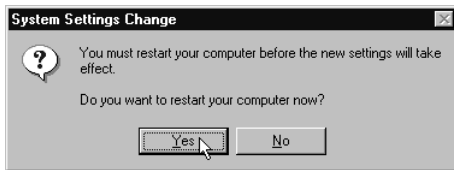

For Windows ME

1. Click on the **Start** menu, point to **Settings** and click on **Control Panel**.
2. Double-click the **Network** icon.
3. The **Network** window appears. On the **Configuration** tab, check out the list of installed network components.
 - Option 1:** If you have **no** TCP/IP protocol, click **Add**.
 - Option 2:** If you have TCP/IP protocol, go to Step 6.
4. Highlight **Protocol** and click **Add**.
5. On the left side of the windows, highlight **Microsoft** and then select **TCP/IP** on the right side. Then click **OK**.
6. While returning to **Network** window, highlight **TCP/IP** protocol for your NIC and click **Properties**.

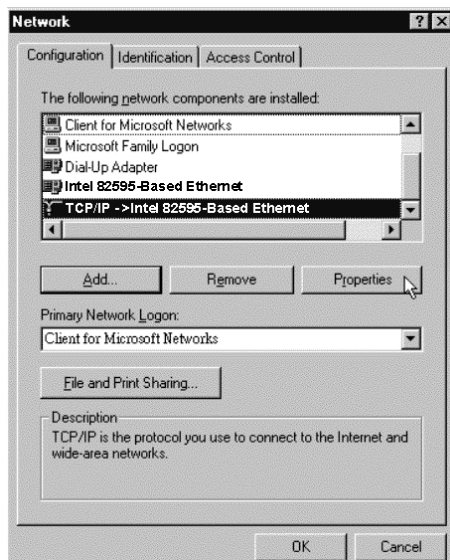

7. On the **IP Address** tab, select **Specify an IP address**. Enter the **IP address: 192.168.100.x** (x is between 2 and 254), **Subnet Mask: 255.255.255.0** and **Default gateway: 192.168.100.100**. Then click **OK**.

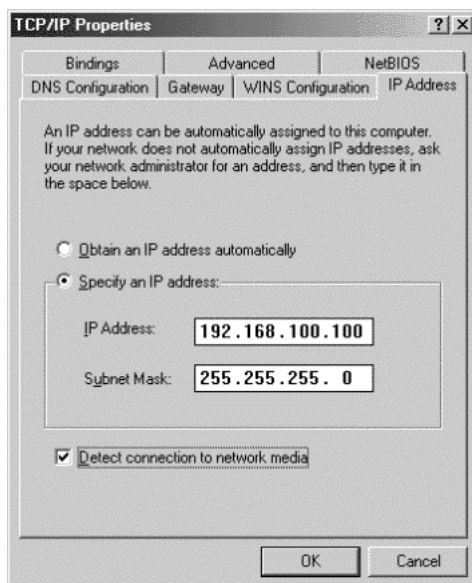

8. While returning to the **Network** window, click **OK**.
9. Wait for Windows copying files.
10. When prompted with the **System Settings Change** dialog box, click **Yes** to restart your computer.

For Windows NT

1. Click **Start**, point to **Settings**, and then click **Control Panel**.

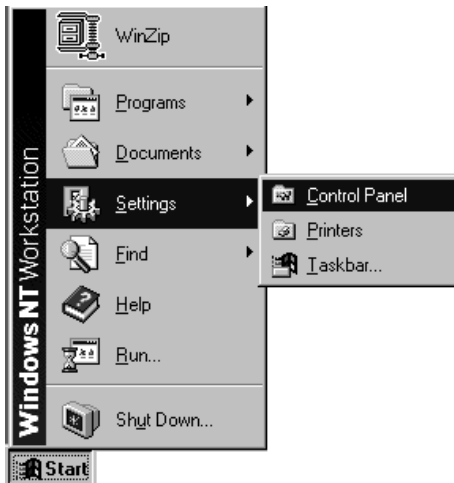

2. Double-click the **Network** icon.

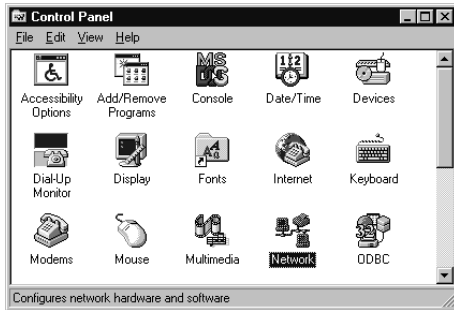

3. The **Network** window appears. On the **Protocols** tab, check out the list of installed network components.

Option 1: If you have **no** TCP/IP Protocol, click **Add**.

Option 2: If you have TCP/IP Protocol installed, go to Step 7.

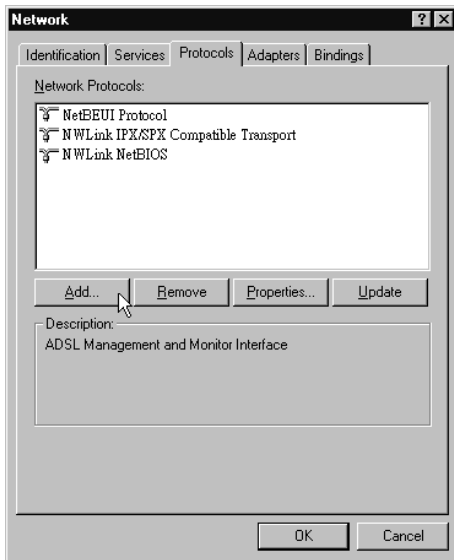

4. Highlight **TCP/IP Protocol** and click **OK**.

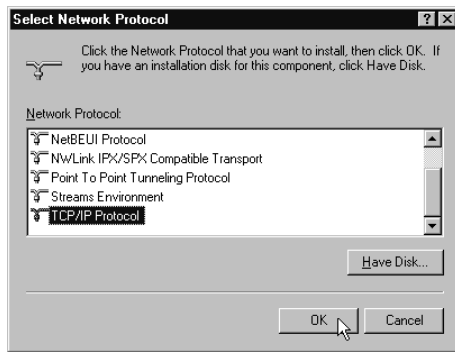

5. Click **Yes** to use DHCP.

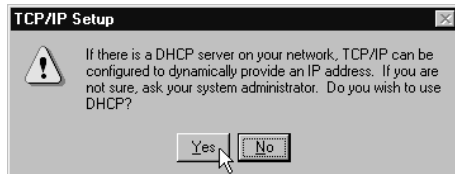

6. Insert the Windows NT CD into your CD-ROM drive and type the location of the CD. Then click **Continue**.

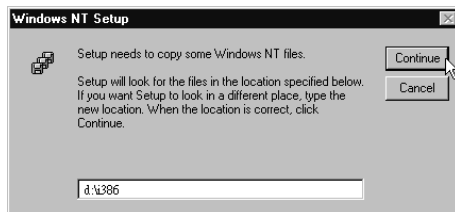

7. Returning to the **Network** window, you will find the **TCP/IP Protocol** among the list. Select **TCP/IP Protocol** and click **Properties**.

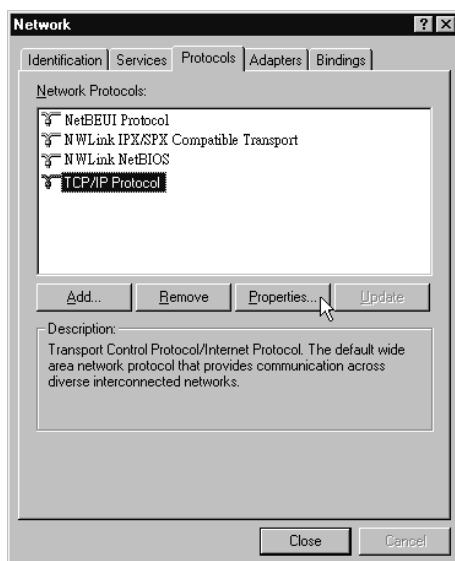

8. Enable **Specify an IP address** option. Enter the **IP Address**: 192.168.100.x (x is between 2 and 254) and **Subnet Mask**: 255.255.255.0 and **Default Gateway**: 192.168.100.100 as in figure below.

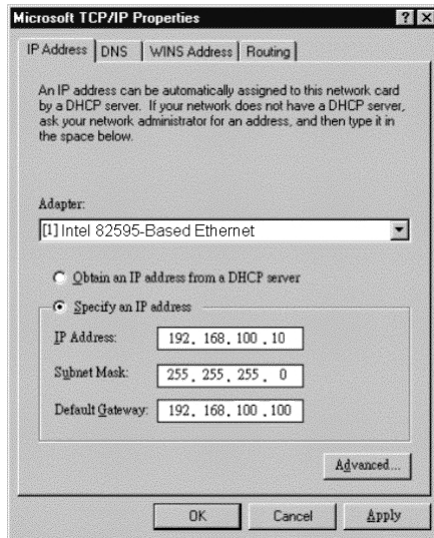

9. When returning to **Network** window, click **Close**.

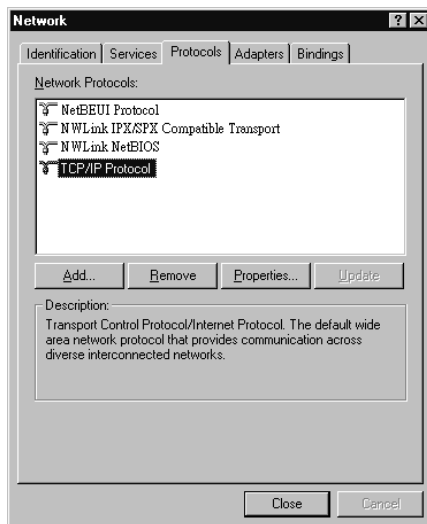

10. When prompted with **Network Settings Change** dialog box, click **Yes** to restart your computer.

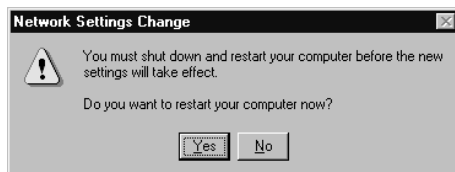

For Windows 2000

1. From the Start menu, point to Settings and then click Network and Dial-up Connections.

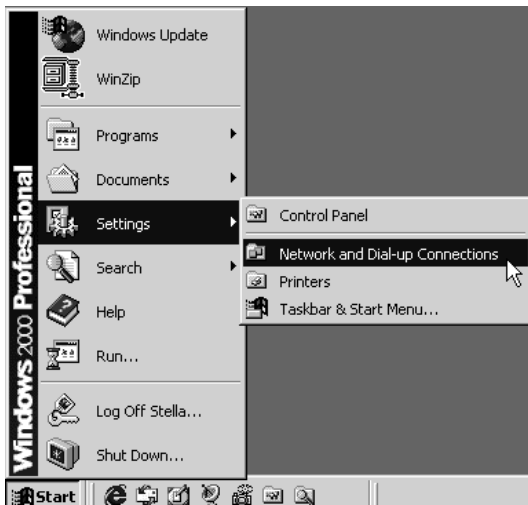

2. Right-click the **Local Area Connection** icon and then click **Properties**.

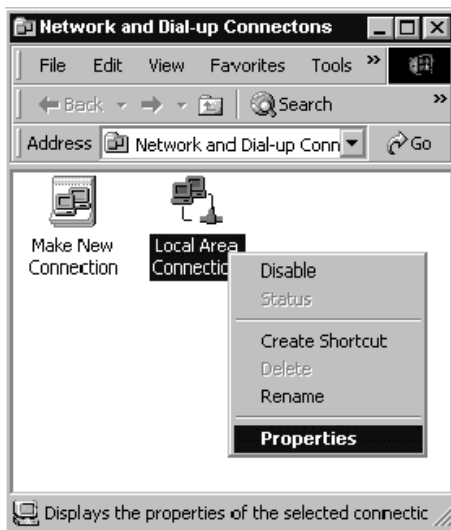

3. On the **General** tab, check out the list of installed network components.

Option 1: If you have **no** TCP/IP Protocol, click **Install**.

Option 2: If you have TCP/IP Protocol, go to Step 6.

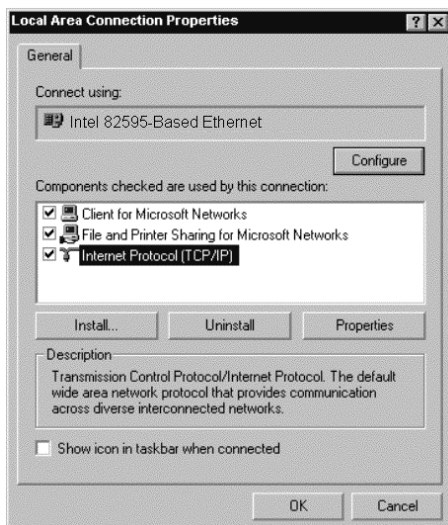

4. Highlight **Protocol** and then click **Add**.

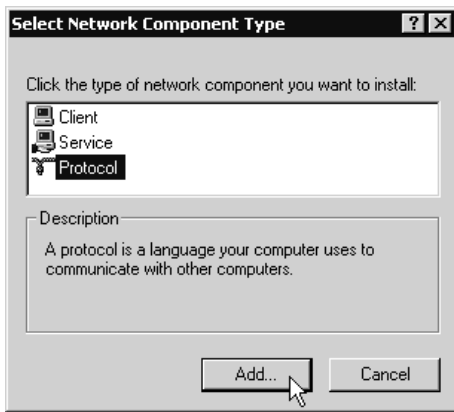

5. Click Internet Protocol(TCP/IP) and then click OK.

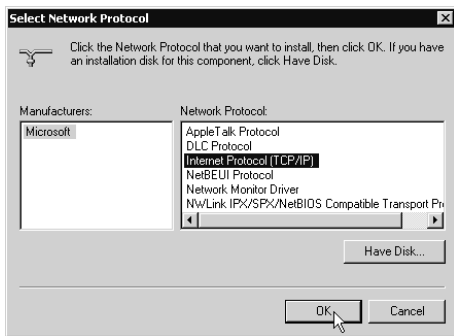

6. When returning to Local Area Connection Properties window, highlight Internet Protocol (TCP/IP) and then click Properties.

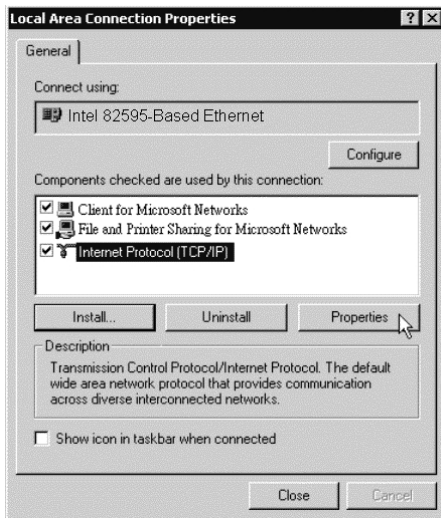

7. Under the **General** tab, enable **Use the following IP Address**. Enter the **IP address: 192.168.100.x** (x is between 2 and 254), **Subnet Mask: 255.255.255.0** and **Default gateway: 192.168.100.100**. Then click **OK**. When prompted to restart your computer, reboot it to enable the settings.

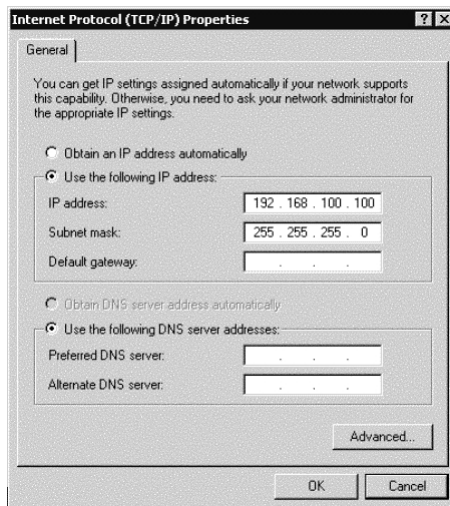

For Windows XP

1. From the **Start** menu, point to **Control Panel** and then click **Network and Internet Connections**.
2. Click **Network Connection** and then click **Properties**.
3. On the **General** tab, check out the list of installed network components.
 - Option 1:** If you have **no TCP/IP Protocol**, click **Install**.
 - Option 2:** If you have **TCP/IP Protocol**, go to Step 6.
4. Highlight **Protocol** and then click **Add**.
5. Click **Internet Protocol(TCP/IP)** and then click **OK**.
6. On the **Local Area Connection Properties** window, highlight **Internet Protocol (TCP/IP)** and then click **Properties**.

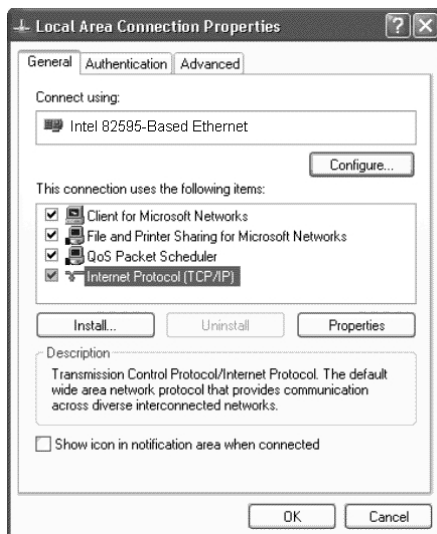

7. Under the **General** tab, enable **Use the following IP address**. Enter the **IP address: 192.168.100.x** (x is between 2 and 254), **Subnet Mask: 255.255.255.0** and **Default gateway: 192.168.100.100**. Then click **Ok**.

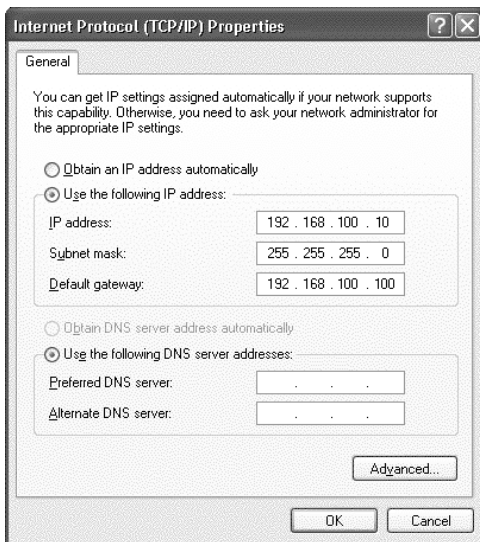

Configure PC to get IP address from DHCP

If your ADSL Router operates as a DHCP server for the client PCs on the LAN, you should configure the client PCs to obtain a dynamic IP address. Please follow the previous section to install TCP/IP component. Only that you do not need to specify an IP address when configuring TCP/IP properties.

The following section describe the procedures for CPEs to get IP address:

For Windows 98

On the **IP Address** tab, select **Obtain an IP address automatically**. Then click **OK**.

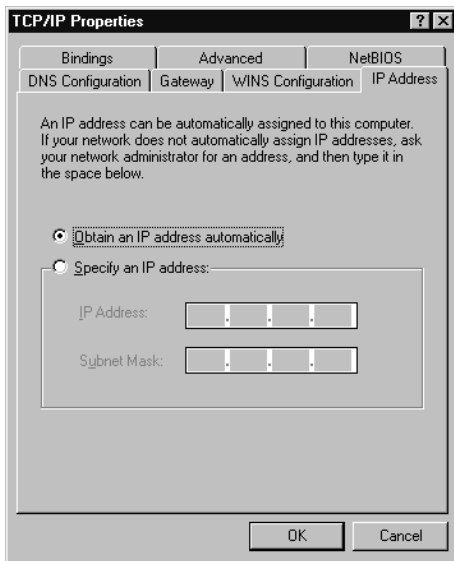

For Windows ME

On the **IP Address** tab, select **Obtain an IP address automatically**. Then click **OK**.

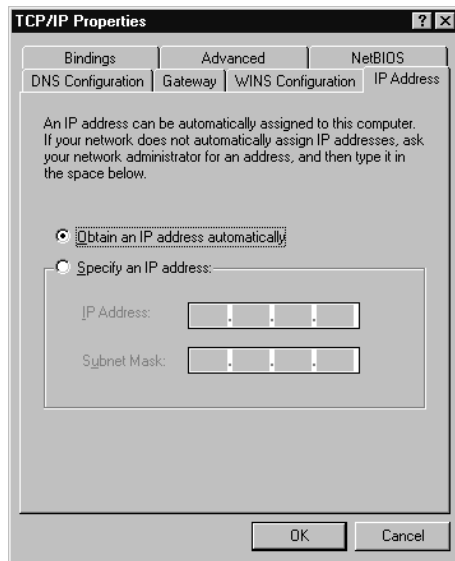

For Windows NT

On the **IP Address** tab, click on the drop-down arrow of **Adapter** to select required adapter. Enable **Obtain an IP address from a DHCP server** and then click **OK**.

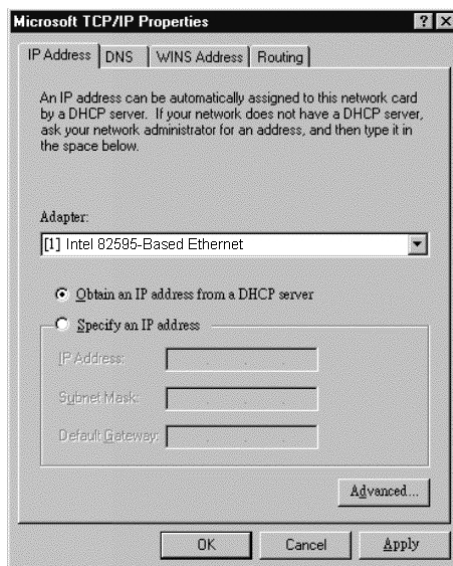

When prompted with the message below, click **Yes** to continue.

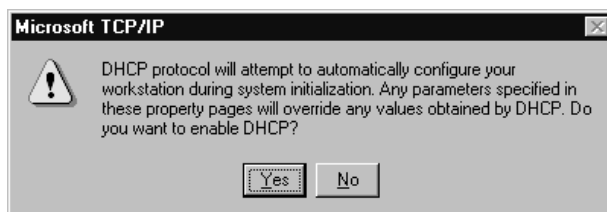

For Windows 2000

Enable **Obtain an IP address automatically** and then click **OK**.

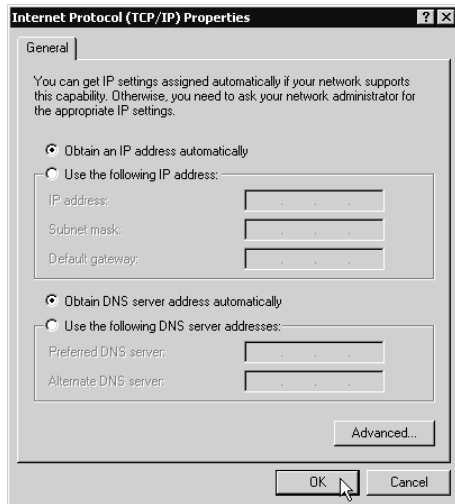

For Windows XP

On the **IP Address** tab, select **Obtain an IP address automatically**. Then click **OK**.

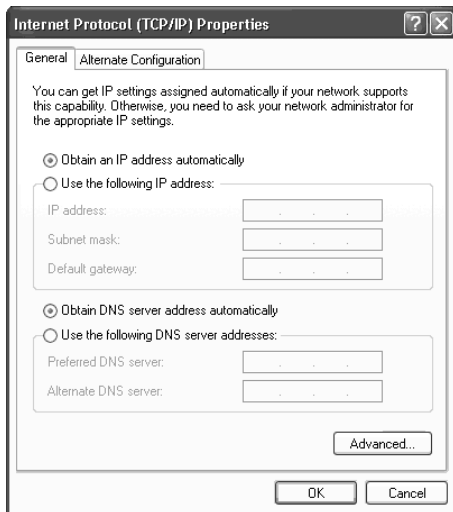

Renew IP Address on Client PC

There is a chance that your PC does not renew its IP address after the ADSL Router is on line and the PC can not access the Internet. Please follow the procedures below to renew PC's IP address.

For Windows 98

1. Select **Run** from the **Start** menu.



2. Type **wiipcfg** in the dialog box and the click **OK**.

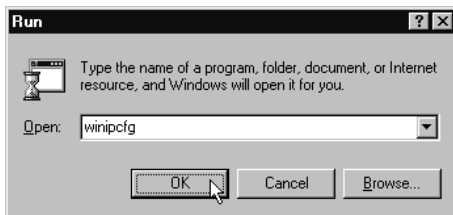

3. When the figure below appears, click **Release** and then **Renew** to get an IP address.

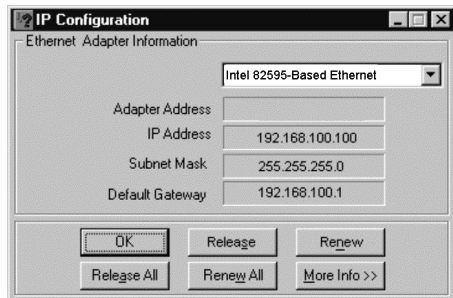

For Windows ME

1. Select **Run** from the **Start** menu.
2. Type **wiipcfg** in the dialog box and the click **OK**.
3. When the figure below appears, click **Release** and then **Renew** to get an IP address.

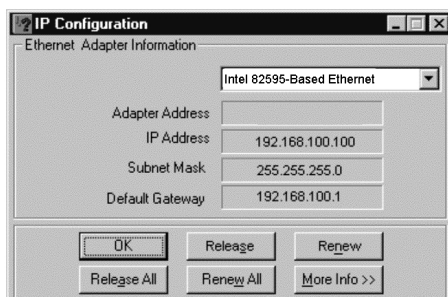

For Windows NT

1. Select **Run** from the **Start** menu.



2. Type **cmd** in the dialog box and the click **OK**.

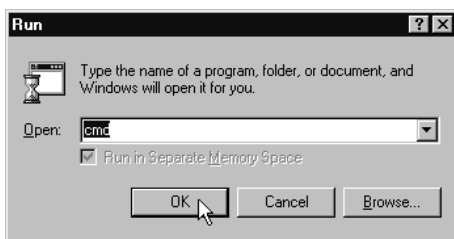

3. Type **ipconfig** at prompt. Then you will see the IP information from DHCP server.
4. If you want to get a new IP address, type **ipconfig /release** to release the previous IP address and then type **ipconfig /renew** to get a new one.

For Windows 2000

1. From the **Start** menu, point to **Programs, Accessories** and then click **Command Prompt**.

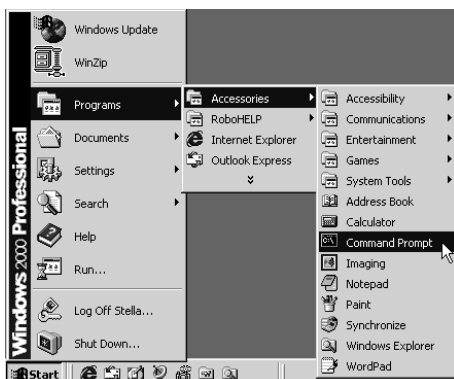

2. Type **ipconfig** at prompt. Then you will see the IP information from DHCP server.
3. If you want to get a new IP address, type **ipconfig /release** to release the previous IP address and then type **ipconfig /renew** to get a new one.

For Windows XP

1. From the **Start** menu, point to **Programs, Accessories** and then click **Command Prompt**.
2. Type **ipconfig** at prompt. Then you will see the IP information from DHCP server.
3. If you want to get a new IP address, type **ipconfig/release** to release the previous IP address and then type **ipconfig/renew** to get a new one.

Chapter 5: Web Configuration

Using Web-Based Manager

Once your host PC is properly configured, please proceed as follows:

1. Start your web browser and type the private IP address of the ADSL Router in the URL field: **192.168.100.100**.
2. After connecting to the device, you will be prompted to enter username and password. By default, the username is **admin** and the password is **admin**. See the following **example** for running under Windows XP.



If you login successfully, the main page of **ADSL ROUTER-CONTROL PANEL** appears. From now on the ADSL Router acts as a web server sending HTML pages/forms on your request. You can fill in these pages/forms and apply them to the ADSL Router.

Outline of Web Manager

The home page is composed of 3 areas:

- Quick Start
- System
- Status
- Configuration

[Quick Start]

DSL Line status: Handshaking

Running Profiles: Refresh

VPI/VCI	Data Encap	NAT	Local WAN IP	On-Line Time	Action
0/32	PPPoE LLC/SNAP	enabled	0.0.0.0	00:00:00:00	Disconnect

Please select the VPI/VCI for your router: 0 / 32

PPP connection status: Down

User Name:

Password:

- **Title:** It indicates the title of this management interface.
- **Main Menu:** Includes Quick start, System, Status, and Configuration.

Quick Start: Allows you to select some pre-defined profile to have basic configuration.

System: The system menu includes the sub-menus of Device Info, Administration, Backup Configuration, Save Configuration, Upgrade Firmware and Reset Router.

Status: Displays the current status of the ADSL Router, including DSL Connection, WAN Connection, Traffic Counter, Routing Table, DHCP Table and Wireless Client.

Configuration: It displays the configuration categories of the ADSL Router, including DSL, LAN, WLAN, WAN, IP Route, DNS, Security, Virtual Server, IGMP Proxy and UPnP settings.

You can move the mouse cursor over the sub-menu to display the hierarchy popup menu. Clicking on each of the item will bring out its content in main window accordingly.

- **Main Window:** It is the current workspace of the web management, containing configuration or status information.

To Have the New Settings Take Effect

The ADSL Router uses the following mechanism to enable new settings:

- **Apply** button.

When **Apply** is clicked, your customizations will only be stored to the DRAM. If you do not execute **Save & Restart**, the customizations will not take effect for rebooting the ADSL Router next time.

- **Save & Restart** button.

When **Save** is clicked, your customizations will be saved to the flash memory. After clicking **Restart**, your customizations take effect.

Quick start

On this page you can select the VPI/VCI value for the connection mode you use. Execute **Apply and Save** to change and save the configuration.

[Quick Start]

DSL Line status: Handshaking

Running Profiles:

Refresh

VPI/VCI	Data Encap	NAT	Local WAN IP	On-Line Time	Action
0/32	PPPoE LLC/SNAP	enabled	0.0.0.0	00:00:00:00	Disconnect

Please select the VPI/VCI for your router:

Apply and Save

8 / 35

- 0 / 32
- 0 / 35
- 8 / 35
- 8 / 81

Please use the drop-down menu to the right side and select the one which suits for your system. Then click on **Apply** and **Save** to show the selected profile data. Different connection modes have different connection result. See the following for reference.

If you want block the connection, just click the **Action** mode—**Disconnect** button. If you choose any one of RFC series profiles, there is no Connect button on the Action mode. In addition, you can click on the item below **VPI/VCI** to show/modify the more detail configurations.

On this home page, you are allowed to change Username and Password for default PPPoE mode.

[Quick Start]

DSL Line status: Handshaking

Running Profiles:

Refresh

VPI/VCI	Data Encap	NAT	Local WAN IP	On-Line Time	Action
0/32	PPPoE LLC/SNAP	enabled	0.0.0.0	00:00:00:00	Disconnect

Please select the VPI/VCI for your router:

PPP connection status: Disabled

User Name:

Password:

Connect and Save

User Name: The name put here is the one that you set on the WAN Configuration web page.

Password: The password put here is the one that you set on the WAN Configuration web page.

Connect and Save: Please click this button to make the PPP connection enabled.

System

Device Information

This page shows the basic information of your ADSL Router, including the hardware board and software version, etc. It provides a general overview of your ADSL Router.

Administration

There are three types of administration, Account, Remote Access and Web Port.

Account

It limits this web-based manager access to users with the correct user name and password. After entering user name & password, click **Apply**. By default, both the user name and password values are **admin**.

To change the user account, type in the new user name, new password and retype the new password on the Confirm Password box. Last, click Apply to finish changing.

[Administration]

Account

Remote Management

Web Port

Administration Account

User Name:

Password:

Confirm Password:

Apply

After clicking **Apply** to change the user name and password, the new setting takes effect immediately. When you continue to access other pages, you will be prompted to re-login with new user name and password immediately.

To save the new settings to flash memory and take effect next time you reboot the ADSL Router, after clicking **Apply**, you should perform the task of **Save Configuration**.

Remote Management

This function allows remote client to access this router from WAN side. You can set the lease time and click **Enable** to enable this setting. Please click the first radio button and type in the duration time on the box or click on the second radio button to choose unlimited time.

[Administration]

Account

Remote Management

Web Port

Remote Management Control

Allow remote access to this router for:

- minutes. (min: 1, max: 1440)
 Unlimited time.

Enable

To disable this function, just click **Disable**.

Remote Management Control

Seconds remaining for remote access: 1800

Remote access: Disable

Web Port

The default web server port is 80. You can change the web server port to another one and then click **Apply** to enable this setting.

Web Port

This router currently runs on the web server port '80'.

Change the web server port to:

Apply

Note:

To activate new setting, you must save configuration and then restart your router.

Note: Clicking **Apply** will enable the new setting right away. When you continue to access other pages, you will need to re-login at new web port.

Backup Configuration

This web page allows you to backup the configuration settings to your computer for retrieving next time. Click on **Backup** button to backup your configuration to your hard disk.

In addition, to retrieve the saved configuration and use again, use **Browse** to locate the backup configuration file. After selecting the desired file, please click **Restore** to use it for current web page.

[Backup Configuration]

This page allows you to backup the configuration settings to your computer, or restore configuration from your computer.

Backup Configuration

Backup configuration to your computer.

Restore Configuration

Restore configuration from a previously saved file.

Configuration File

Save Configuration

This page allows you to save all current configuration settings to non-volatile memory. Please wait for several seconds to complete this process.

[Save Configuration]

This page allows you to save all current configuration settings to non-volatile memory. Please wait for several seconds to complete this process.

WARNING: DO NOT turn off your router while the configuration is being saved.

Upgrade Software

The ADSL Router supports the upgrading by using HTTP. To transfer the firmware file, follow the steps below:

1. Download and unzip the new software file from vendor.
2. In the **File Name of Firmware** field, click **Browse** to locate the upgrade files.
3. Click the **Upgrade** button.

[Upgrade Firmware]

Current firmware version: 5.1.0.4 (19 May 2003)

WARNING: DO NOT turn off your router during firmware upgrades.

File Name of Firmware:

Note:

The status of firmware upgrade will be displayed after the firmware upload is complete.
Please wait for the status update before continuing

After upgrading, the original configuration will still exist and not reset to the factory defaults.

Reset Router

This page allows you to restart your router for invoking new configuration. After restarting, you should wait for several seconds to let the system come up. When restarting the system, your browser session will be disconnected. Please wait until the device finish restarting.

[Reset Router]

This page will allow you to restart your router. After restarting, please wait for several seconds to let the system come up. If you would like to reset all configuration changes to the factory default settings, please check the box below and then click the Restart button.

Reset to factory default settings

Note: If **Reset to factory default settings** is checked, the settings will return to factory defaults, including the **Username** and **Password**.

Status

DSL Connection

This page shows the DSL line connection status as below:

[DSL Connection]

Refresh

Line Mode	Inactive	Line State	Handshaking
DS Speed	8000 Kbps	US Speed	1024 Kbps
DS Latency	Interleave	US Latency	Interleave
Trellis Coding	Enabled	Loss of Signal	0
DownStream Tx Power		UpStream Tx Power	
DownStream Line Attenuation		UpStream Line Attenuation	
Loss of Frame	0	Noise Margin	14dB
CRC Error	0	Line Up Count	0
Error Second	0 seconds	Line Up Time	0:00:03:41
System Up Time	0:01:22:36		

Line Mode: The ADSL Router supports multi-mode standard.

DS (Downstream)/US (Upstream) Speed: The downstream/upstream speed of the DSL line.

DS/US Latency: Displays whether a fast or interleaved latency path is specified.

Trellis coding: Indicates trellis coding is enabled or disabled. Trellis coding is a method of providing better performance in a noisy environment. It helps to transmit at faster line rates with lower error rates, thus providing a faster overall throughput in a moderately noisy environment.

Line Attenuation: Indicates the signal attenuation caused by line length. It increases with line length and frequency and decreases as wire diameter increases.

Noise Margin: Signal to noise ratio. The ratio of good data (signal) to bad (noise) on the line that is expressed in decibels (dB).

Loss of Signal /Frame: Indicates the loss of signals or frames detected.

CRC Error: Cyclic Redundancy Checksum generated.

Line Up Count: The number of times that you connect to.

Line Up Time: The duration time of the line connecting.

Error Second: The accumulated seconds of the seconds during which packet error message occur.

System Up Time: The time from system startup.

WAN Connection

This page shows all the ATM PVC interfaces you defined. For each ATM PVC interface, it shows the parameter you defined for ATM PVC name, VPI/VCI values, Mode, Encapsulation Type and Local WAN IP address.

[WAN Connection]

Refresh

PVC Name	VPI	VCI	Data Encap	NAT	Local WAN IP
ppp-0	0	32	PPPoE LLC/SNAP	enabled	0.0.0.0

Traffic Counter

This page shows the records of data going through the LAN and WAN interface. For each interface, cumulative totals are displayed for **Sent/Received Packets** and **Sent/Received Bytes**.

[Traffic Counter]

The statistic of user data going through your router is list below.

Refresh

Connection	Tx Packets	Rx Packets	Tx Bytes	Rx Bytes
Ethernet	704 / 0	560 / 0	391593	76466
Wireless Lan	69 / 0	0 / 0	12002	0
8 / 35 (vpi/vci)	46 / 14	0 / 0	15088	0

By clicking **Refresh**, all the records will be reset.

Routing Table

This page shows all the routing rules of data packets going through your ADSL Router if it runs in routing mode. By clicking **Refresh**, all the records will be reset.

[Routing Table]

All of current routing rules in your router are listed below.

Refresh

Destination	Netmask	Gateway / Interface	Cost	Timeout	Attribute
0.0.0.0	0.0.0.0	ppp-0	1	0	static

DHCP Table

This page shows all DHCP clients who get their IP addresses from your ADSL Router. For each DHCP client, it shows the **Host Name**, **MAC Address**, **IP Address** and the **Lease Time**.

[DHCP Table]

All clients who got their IP addresses from your router are listed below.

Refresh

Host Name	MAC Address	IP Address	Lease Time
CARRIENI	00:c1:26:0a:69:2b	192.168.100.101	00:23:20:13

Wireless Client

This page shows wireless clients that associated to the router. For each client, it shows the **MAC Address** and the **On-Line Time**.

[Wireless Client Table]

All wireless LAN Clients currently associated to your router are listed below.

Refresh

MAC Address	On-Line Time
-------------	--------------

Configuration

DSL Configuration

DSL Line Mode: The ADSL Router supports multi-mode standard: **Auto**, **G.lite**, **G.dmt** and **ANSI T1.413**. Choose an appropriate line mode according to the setting of DSLAM in central office and then click **Apply**.

[DSL Connection]

Refresh

Line Mode	Inactive	Line State	Handshaking
DS Speed	8000 Kbps	US Speed	1024 Kbps
DS Latency	Interleave	US Latency	Interleave
Trellis Coding	Enabled	Loss of Signal	0
DownStream Tx Power		UpStream Tx Power	
DownStream Line Attenuation		UpStream Line Attenuation	
Loss of Frame	0	Noise Margin	14dB
CRC Error	0	Line Up Count	0
Error Second	0 seconds	Line Up Time	0:00:03:41
System Up Time	0:01:22:36		

Current DSL Line Mode : ▼

Apply

The DSL line mode you specify will be applied to the entire ADSL Router unit. All ATM PVC profiles created will use the same line mode. Consult your ISP to find out which option applies to your DSL line.

LAN Configuration

For the LAN Configuration, there are two types that you have to know, IP Address and DHCP Server.

[LAN Configuration]

IP Address	DHCP Server
------------	-------------

IP Address

Primary IP Address

IP Address:

Subnet Mask:

Secondary IP Address

IP Address:

Subnet Mask:

Apply

Note: there may be a short pause between clicking *Apply* and receiving a response.

IP Address

LAN Configuration allows you to define the public/private IP address over the LAN interface.

Primary IP Address: Private IP address is used for the purpose of system management. When it is assigned, PC on the LAN is able to use the specified address to access this ADSL Router through Ethernet.

By default, the IP address and subnet mask is **192.168.100.100** and **255.255.255.0** respectively. This will give you an available range of IP addresses from 192.168.100.2 to 192.168.100.254 that can be assigned to PCs on the LAN.

Secondary IP Address: If you applied for multiple IP address from your ISP, you will have a range of IP address for the ADSL Router and other network devices on the LAN. You can fill in the IP address assigned by ISP in the public IP address field.

DHCP Server

This page allows you to enable DHCP server on LAN interface and then your router can assign IP addresses to those PCs connected to your router.

[LAN Configuration]

IP Address	DHCP Server
DHCP Server	
The DHCP Server is currently enabled.	
Subnet:	192.168.100.0
Subnet Mask:	255.255.255.0
Lease Time:	01:00:00:00
IP range:	192.168.100.101 - 192.168.100.103
Domain Name Server:	202.96.209.5,202.96.209.133
Domain Name:	lan
Please select the DHCP Server to be:	
<input type="radio"/> Disabled <input checked="" type="radio"/> Enabled <input type="radio"/> Relay Agent	
Configure	

The ADSL Router implements a built-in DHCP (Dynamic Host Configuration Protocol) server, which dynamically assigns IP addresses and DNS server to the PCs on the LAN. DHCP function spares you the hassle of manually assigning a fixed IP address to each PC on the LAN. It is probably you already have a DHCP server on your network and you do not enable this function. By default the DHCP Server is enabled on private LAN interface (192.168.100.0).

Choose the **Enabled** radio button and click **Configure** to get advanced settings. Enter the requiring information and click **Apply** to invoke the configurations that you set. Below is the web page for setting DHCP server.

[LAN Configuration]

IP Address	DHCP Server
DHCP Server	
<i>DHCP Server is only applied on LAN Primary IP Interface currently.</i>	
Please enter details for DHCP Server configuration:	
Interface:	Primary LAN ▾
Start IP Address:	192 . 168 . 100 . 101
End IP Address:	192 . 168 . 100 . 103
DHCP lease time	1 days 0 hours 0 minutes
Default Gateway	
Report this host as the default gateway	<input checked="" type="checkbox"/>
Default Gateway	_____ . _____ . _____ . _____
Domain Name Servers	
Report this host as DNS server	<input type="checkbox"/>
Primary DNS server address	202 . 96 . 209 . 5
Secondary DNS server address	202 . 96 . 209 . 133
Domain Name:	lan
<input type="button" value="Apply"/>	

Interface: Select the interface for the connection of DHCP server. The default one is Primary LAN.

Start IP Address: Decides the start point of the IP range for this connection.

End IP Address: Decides the end point of the IP range for this connection.

DHCP lease time: Type in the time that a network device can lease a private IP address before the ADSL Router reassigning the IP address.

Report this host as the default gateway: Check this box to enable this function.

Default Gateway: You check the **Report this host as the default gateway** box to use this host as the default gateway or fill in an IP address as the default gateway.

Report this host as DNS server: Check this box to enable this function.

Primary DNS server address: Type in the first DNS server address that you get from your ISP.

Secondary DNS server address: Type in the second DNS server address that you get from your ISP.

Domain Name Servers: You can check the **Report this host as the DNS server** box to use this host as the default DNS. Or you can uncheck the box and manually set up the DNS IP address in the **Primary/Secondary DNS IP address** fields. The DNS server addresses will be passed to the DHCP clients along with the IP addresses. The DHCP clients use the DNS to map a domain name to its corresponding IP address and vice versa.

Configuration for Relay Agent

If you want the DHCP server to have the function of relay, please set the Relay Agent for the server. Click the **Relay Agent** button from the DHCP Server page to get advanced settings. Please enter the IP address for the DHCP Server and click **Apply** to invoke the configurations.

DHCP Relay Agent

The DHCP Server is currently enabled.

Subnet: 192.168.100.0
Subnet Mask: 255.255.255.0
Lease Time: 01:00:00:00
IP range: 192.168.100.101 - 192.168.100.103
Domain Name Server: 202.96.209.5,202.96.209.133
Domain Name: lan

Please enter details for DHCP Relay configuration:

DHCP Server IP address:

WLAN Configuration

This setting is available for wireless router only.

This section shows you how to configure the wireless LAN setting. To types are provided here, Basic Setup and Association Control.

Basic Setup

[Wireless LAN Configuration]

Basic Setup	Association Control
Basic Setup	
Wireless SSID : <input type="text" value="CTC"/> (<input type="checkbox"/> Hide SSID)	
Desired Channel : <input type="text" value="Channel 6 [2437 MHz]"/>	
Authentication Type: <input type="text" value="Auto"/>	
Wired Equivalent Privacy Mechanism: <input type="text" value="OFF"/>	
If the Wired Equivalent Privacy mechanism is turned on, those user data transferred through wireless LAN will be encrypted. Please select encryption key length and fill out WEP keys.	
Use passcode to generate WEP keys: <input type="text"/> <input type="button" value="Generate"/>	
<input checked="" type="radio"/> 64-bit Encryption Key Length	
WEP Key 1: <input type="text" value="00-00-00-00-00"/> (e.g., 1a-01-d2-8c-3b)	
WEP Key 2: <input type="text" value="00-00-00-00-00"/>	
WEP Key 3: <input type="text" value="00-00-00-00-00"/>	
WEP Key 4: <input type="text" value="00-00-00-00-00"/>	
<input type="radio"/> 128-bit Encryption Key Length	
WEP Key 1: <input type="text" value="00-00-00-00-00-00-00-00-00-00-00-00-00-00-00-00"/> (e.g., 1a-01-d2-8c-3b-cc-dd-03-90-66-aa-bb-25)	
WEP Key 2: <input type="text" value="00-00-00-00-00-00-00-00-00-00-00-00-00-00-00-00"/>	
WEP Key 3: <input type="text" value="00-00-00-00-00-00-00-00-00-00-00-00-00-00-00-00"/>	
WEP Key 4: <input type="text" value="00-00-00-00-00-00-00-00-00-00-00-00-00-00-00-00"/>	
Default transmission key: <input type="text" value="WEP Key 1"/>	
<input type="button" value="Apply"/>	

Wireless SSID (Service Set Identity): A name that uniquely identifies a wireless domain. All wireless clients that want to communicate with the ADSL Router must have the same SSID as it.

Frequency Domain: The frequency in which the radio links are about to be established.

Desired Channel: The frequency in which the radio links are about to be established. Select channel that you want. Usually the wireless clients will scan the whole operable channels and then select the desired communications channel automatically.

Authentication Type: The ADSL Router supports three authentication types: **Open System**, **Shared key** and **Auto**. This should be considered with the WEP (Wired Equivalent Privacy) mechanism.

Wired Equivalent Privacy Mechanism

The privacy security function can enhance wireless media security by encryption technology. All wireless clients must set the same encryption key to maintain the tightened communication with the ADSL Router properly. The Authenticate Algorithm options are:

When the wired Equivalent Privacy Mechanism is Turns off. Using Open-key as authentication algorithm, you are running the risk of allowing some unauthorized wireless LAN cards that have the capability of eavesdropping your SSID to associate itself to the device.

Turns on encryption. Wired Equivalent Privacy Mechanism is Turns on. You should select the encryption key length as 64 or 128 bit key. Then enter the encryption key in Key Entry fields.

Note: When Wired Equivalent Privacy Mechanism is enabled, the wireless client must be configured with exactly the same encryption level (64 or 128-bit) and encryption key as identified in the ADSL Router, so that access to the unit is allowed.

In addition, you can press the **Generate** button to use the passcode for generating WEP keys.

Association Control

You can enable this control to associate to your router with other wireless clients. Select **Enabled** and enter the MAC address on the Client's MAC Address box. Then click **Apply**.

[Wireless LAN Configuration]

Basic Setup

Association Control

Association Control

Association control function is currently disabled.
Any wireless LAN client is allowed to associate to your router under the same SSID and channel.

Please select the Association Control to be:

- Disabled
- Enabled

Client's MAC Address : (e.g., 00:90:96:1A:2B:3C)

Apply

WAN Configuration

The ADSL Router supports for Asynchronous Transfer Mode (ATM) over ADSL. To set up connections over the WAN, you have to define ATM PVC interface for each remote connection. On this page, you can create, modify and delete PVC interface.

[WAN Configuration]

ATM PVCs currently created: Refresh

PVC Name	VPI/VCI	Data Encap	NAT	Local WAN IP	Modify	Delete
ppp-0	0/32	PPPoE LLC/SNAP	enabled	0.0.0.0	Modify	Delete

[Create a new PVC](#)

You can select an existing ATM PVC interface and click **Modify** to edit its parameters or click **Delete** if you want to delete it.

To add a new PVC interface, click **Create a new PVC** and follow these steps:

1. Select one of connection type in the Data Mode (RFC1483 Bridged, RFC1483 Routed, RFC1483 MER, PPPoA or PPPoE) and click **Next**.

[WAN Configuration] - Create ATM PVC Connection

Please select data mode for the ATM PVC you wish to create:

Data Mode: RFC1483 Bridged RFC1483 Routed RFC1483 MER
 PPPoA PPPoE

[Next](#)

2. Fill in the VPI/VCI values and select ATM Service Type, Encapsulation Type and PCR.

ATM Properties

VPI: (min: 0, max: 255)
 VCI: (min: 32, max: 4095)
 ATM Service Type:
 PCR (Peak Cell Rate): cells per second (min: 10, max: 2500)
 Encapsulation Type:

[Apply](#)

3. Click **Apply**.
4. At RFC1483 Routed, RFC1483 MER and PPP mode Configuration, you can select Specify an IP address or Server assigned IP address.

IP Configuration

Local WAN IP Address: None
 Specify an IP Address
 IP Address:
 Subnet Mask:
 Server assigned IP Address (via DHCP client)
 Enable NAT on this interface

Apply

- Unless your ATM PVC is set on RFC1483 Bridged mode, you can check NAT box to enable NAT function.
- If you are using PPP configuration mode, you need to fill in the user name and password and you can set the PPP session to Dial on demand or Always on mode.

PPP Configuration

User Name:
 Password:
 Authentication Type:
 Service Name:
 Service Server:
 Session established by: Dial On Demand
 If there are no data traffic during minutes,
 this PPP session will be terminated.
 Always On
 Enable NAT

Apply**Parameter Description**

The parameters are described as below:

VPI (Virtual Path Identifier): Identifies the virtual path between endpoints in an ATM network. The valid range is from 0 to 255.

VCI (Virtual Channel Identifier): Identifies the virtual channel endpoints in an ATM network. The valid range is from 32 to 4095 (1 to 31 is reserved for well-known protocols).

ATM Service Type: Currently, the ADSL Router supports the **UBR (Unspecified Bit Rate)** service type.

PCR (Peak Cell Rate): Specify the PCR cells per second.

Encapsulation Type: There are two types for your choosing, VC MUX or LLC/SNAP. Select the encapsulation based on the setting of the ISP. Consult your ISP for this information.

Local WAN IP Address: On Router mode, selecting **None** means you have public LAN IP address setting. If you select **Specify an IP address**, you can specify a WAN IP provided by ISP for your router. If **Server assigned IP address** is selected, the router will get a dynamic WAN IP address whenever it connects to the remote server or ISP.

Note: If a fixed WAN IP is entered, note that this IP address and the subnet mask could not be the same with the public LAN interface.

Enable NAT on this interface: If your LAN interface is set on primary LAN you should check the box of the Enable Network Address Translation. NAT translates a private IP within one network to a public IP address.

User Name/Password: The user name and password used to access the remote server or ISP.

- Dial On Demand:** If checked, under disconnected status, if any client PC sends out request for connection, the ADSL Router will dial the ISP automatically. In this case, if the system administrator wants to disconnect the PPP session, just click the **Disconnect** button at Quick Start page.
- Always On:** Enabling this feature will send echo request to ISP. This prevents the connection from being hung up by ISP.

The parameters for PPPoE configuration are generally the same as those of PPPoA. The additional parameters are:

- Service Name:** Enter the name of your PPPoE service here.
- Service Server:** Enter the name of your PPPoE service server here.

Note: When you initially add an PVC for the PPP connection and connect to ISP, a default routing of **0.0.0.0** is added automatically to the IP Static Routing. If you set up more than one PVC profiles and the first PVC is deleted, then you have to manually add the default routing.

IP Route

This web page allows you to set the route for data transmission.

[IP Route]



Static Route

Static routes currently created:

Destination	Netmask	Gateway / Interface	Delete
0.0.0.0	0.0.0.0	ppp-0	Delete

Create a new route

Static Route

This page shows all static route status and allows you to add new static IP route or delete IP route. A Static IP Routing is a manually defined path, which determines the data transmitting route. If your local network is composed of multiple subnets, you may want to specify a routing path to the routing table.

You can click **Create a new route** to add new route.

Static Route - Create New Route

Destination Address: . . . (for default route: 0.0.0.0 or leave blank)

Netmask: . . . (for default route: 0.0.0.0 or leave blank)

Forward packets to: Gateway Address: . . .

Interface:

Apply

- Destination Address:** The destination IP address of the network where data packets are to be sent.
- Netmask:** The subnet mask of the destination IP address.
- Forward packets to:** If you want add a rout on LAN side, you should choose the **Gateway Address**. Enter the router address and then click **Apply**. If you want add a rout on WAN side, you should choose the **Interface**. Select ATM PVC interface and then click **Apply**.

Dynamic Routing

Routing Information Protocol (RIP) is utilized as a means of exchanging routing information between routers. It helps the routers to determine optimal routes. This page allows you to enable/disable this function.

Dynamic Routing

Current settings:

Interface Name	Receive Mode	Transmit Mode
ppp-0	RIP disabled	RIP disabled
Primary Lan	RIP disabled	RIP disabled
Secondary Lan	RIP disabled	RIP disabled

Please enter details for RIP configuration:

Interface Name:

Receive Mode:

Transmit Mode:

By default, RIP is disabled with **Disabled** selected. You are allowed to enable RIP over the primary LAN interface. Upon each interface, you can customize the RIP on **Receive Mode** and **Transmit Mode** respectively.

- Interface Name:** It decides the interface of the network that you want to use.
- Receive Mode:** It incorporates the RIP information when receiving the RIP packets. From the drop-down list select which RIP version should be accepted, RIP disable, RIPv1, RIPv2 and both.
- Transmit Mode:** It broadcasts the routing table. From the drop-down list select which RIP version should be broadcasted, RIP disable, RIPv1, RIPv2 and both.

DNS

DNS Relay

On this page you can choose to disable or enable DNS Relay function. If your DNS is disabled and you choose to enable DNS relay, after selecting the **Enabled** option, please click **Configure** and then specify up to three DNS IP addresses in the **DNS server 1-3 IP address** fields. Then click **Apply** to enable the DNS relay function.

[DNS]

<input type="button" value="Relay"/>	<input type="button" value="Server"/>
--------------------------------------	---------------------------------------

DNS Relay

The DNS Relay is currently enabled. Relaying to:

Please select the DNS Relay to be:

- Disabled
- Enabled

While the ADSL supports DNS Relay, it is regarded as a DNS server that is responsible for forwarding the name address inquiry for the host. On the Router mode, the manager must type in the DNS server address of the ISP manually. For example, if you are the first time to log in DNS Relay page, when you choose Enabled and enter this page by clicking **Configure**, the page will show **DNS server 1-3 IP address** fields. Enter the addresses and click **Apply**.

Yet, on MER, PPPoA or PPPoE mode, ADSL will get the DNS server address automatically from ISP. The manager

does not need to type in the DNS server address. Simply click Enabled item on DNS Relay settings and leave the address entry lines blank. Finally, click Apply. DNS Relay will be invoked.

DNS Relay

The DNS Relay is currently enabled. Relaying to:

Please enter details for DNS Relay configuration:

DNS Server 1 IP address: . . .

DNS Server 2 IP address: . . .

DNS Server 3 IP address: . . .

Apply

If you have been setting before, the page will show all the DNS Relay status. To disable DNS relay, just select the **Disabled** option then click **Configure**. To modify setting select enable and click **Configure** again.

DNS Relay

The DNS Relay is currently enabled. Relaying to:

168.95.1.1 (manual input)

Please select the DNS Relay to be:

- Disabled
- Enabled

Configure

DNS Server

The DNS server address will be passed to the DHCP clients along with the IP address and the DHCP clients use the DNS to map a domain name to its corresponding IP address and vice versa.

[DNS]

Relay	Server
--------------	---------------

DNS Server

The DNS Server is currently enabled and the domain name is 'lan'.

Please select the DNS Server to be:

- Disabled
- Enabled

Apply

Create a new DNS hostname entry manually

Refresh

The DNS hostname table containing all current DNS clients created:

Host Name	IP Address	Creator	Delete
CARRIENI	192.168.100.101	DHCP	

DNS Server: Select **Enabled** or **Disabled** to enable/disable the DNS server and then click **Apply**. The DNS hostname table shows all the current DNS clients, whether created by DHCP client or manually created. If it created by manual client, you can delete the hostname entry on the table.

Create New DNS Hostname Entry: To add new hostname entry, please click **Create a new DNS hostname entry manually** button. Then fill in the **Hostname** and **IP address** and click **Apply**.

DNS Server - Create New Hostname Entry

Please enter details for the hostname of new DNS client:

Hostname:
 IP Address: ...

Apply

Delete Hostname Entry: To delete the hostname entry, select the required one from the DNS hostname table. After confirming the data, click **Delete**.

Disabled
 Enabled

Apply

Create a new DNS hostname entry manually

Refresh

The DNS hostname table containing all current DNS clients created:

Host Name	IP Address	Creator	Delete
CARRIENI	192.168.100.101	DHCP	
SAVE1	192.168.100.107	Manual	Delete

Note:

1. When DNS Relay is disabled, the DNS server function is invalid.
 2. If DNS IP is left as 0.0.0.0, then you should specify the DNS on each client PC.
-

Security

Firewall

This page is used to set the firewall for your system. Please choose one from the provided items and click **Apply** to enable it.

[Security]

Firewall	Intrusion Detection
----------	---------------------

Firewall

The firewall function is currently disabled.

Please select the firewall to be:

- Off (Firewall Disabled)
- Low
- Medium
- High
- Block (All Traffic Blocked)
- Advanced (User Define)

Apply

Note: The table of default policies for various security levels.

Click on **The table of default policies for various security levels** to see the traffic blocked status for each setting.

The default policies for various security levels are applied as below. Other application services which are not listed here are blocked if the firewall is enabled.

Security Level		Low		Medium		High	
Service	Port	In	Out	In	Out	In	Out
HTTP(tcp)	80	Yes	Yes	No	Yes	No	Yes
DNS(udp)	53	Yes	Yes	No	Yes	No	Yes
FTP(tcp)	21	Yes	Yes	No	Yes	No	Yes
Telnet(tcp)	23	Yes	Yes	No	Yes	No	Yes
ICMP	N/A	Yes	Yes	Yes	Yes	No	Yes
SMTP(tcp)	25	Yes	Yes	No	Yes	No	Yes
POP3(tcp)	110	Yes	Yes	No	Yes	No	Yes
Lotus Note(tcp/udp)	1352	YES	Yes	No	Yes	No	YES
HTTP-SSL(tcp)	443	Yes	Yes	No	Yes	No	Yes
News-NNTP(tcp)	119	Yes	Yes	No	Yes	No	No
Internet Locator Server(tcp)	389	Yes	Yes	Yes	Yes	No	No
User Location Server(tcp)	522	Yes	Yes	Yes	Yes	No	No
T.120(tcp)	1503	Yes	Yes	Yes	Yes	No	No
H.323 call setup(tcp)	1720	Yes	Yes	Yes	Yes	No	No
Audio call control(tcp)	1731	Yes	Yes	Yes	Yes	No	No
MSN Messenger File Transfer(tcp)	6891-6900	Yes	Yes	Yes	Yes	No	No
Remote Messenger Remote Assistance(tcp)	3389	Yes	Yes	Yes	Yes	No	No
MSN Messenger Messaging(tcp)	1863	Yes	Yes	Yes	Yes	No	No
MSN Messenger Voice Comm (tcp/udp)	6901	Yes	Yes	Yes	Yes	No	No
Yahoo! Messenger Webcam(tcp)	5100	Yes	Yes	Yes	Yes	No	No
mIRC Client(tcp)	6667	No	Yes	No	Yes	No	No
CuSeeMe(tcp)	7648	No	Yes	No	Yes	No	No
RealAudio/Video(tcp/udp)	554	Yes	Yes	No	No	No	No
RealAudio/Video(tcp)	7070-7071	Yes	Yes	No	No	No	No

The higher the security level is, the more traffic blocked for the service is.

When the firewall is disabled, it will be OK for accessing in/out Internet, and the router will support PPTP packet and IP Sec Packet for passing through. Yet, when the firewall is enabled with choosing Low, Medium or High, your system will follow the rule listed on the table of default policies for managing the access in/out Internet to forward packet. If you found some software cannot work properly while enabling firewall, but can work while disabling firewall, you have to select Advance (User define) to configure the policies manually by setting mapping protocol (TCP, UDP) and port number. And set the Direction in Bound as **Allow** or **Block**, out Bound as **Allow**.

To have a user define firewall setting, please select **Advanced (User Define)** firewall and click **Apply**. There are two selections for packet filtering rules appeared to ask you choosing one. Please choose the one you want and click **Configure**.

Firewall

The firewall function is currently enabled and security level is set to 'Advanced'.
"Any created virtual server entry will bypass the firewall rules."

Please select the firewall to be:

- Off (Firewall Disabled)
- Low
- Medium
- High
- Block (All Traffic Blocked)
- Advanced (User Define)

Apply

Note: The table of default policies for various security levels.

Please configure packet filtering rules :

- between WAN and Primary LAN
- between WAN and Secondary LAN

Configure

You have to select the interface from one of the radio buttons and click **Configure**. Later, in the next page, a button named **Create a new filtering rule** will appear. Click on this button to get into next page.

Firewall - Between WAN and Primary LAN

Create a new filtering rule

The rules for IP packet filtering created:

Protocol	Local Side		Remote Side		Port Range		Direction	
	IP Addr	Netmask	IP Addr	Netmask	Start	End	In	Out
TCP	0.0.0.0	0.0.0.0	0.0.0.0	0.0.0.0	80	80	Allow	Allow
UDP	0.0.0.0	0.0.0.0	0.0.0.0	0.0.0.0	53	53	Allow	Allow

Example

Here provides you the way and the result of creating a new filtering rule. This is just an example and just for your reference.

If you want enable the firewall and access into PPTP server for some reason, you can:

- Set the protocol type as **TCP** and set the port range value start point as **1723**, or
- Set the protocol type as **User Defined** and set the number as **47**.

After you click the **Create a new filtering rule** button, the following screen will appear. Please fill in the boxes and click **Apply** to close this screen.

[Security]

Firewall	Intrusion Detection
-----------------	----------------------------

Firewall - Create a New Filtering Rule

Please enter details for the filtering rule:

Protocol Type: as

Local Side

IP Address: Netmask:

Remote Side

IP Address: Netmask:

Port Range

Start: End:

Direction

In Bound: Out Bound:

- Protocol Type:** Select the type that you want for the filtering rule.
- Local Side:** Type in the source IP address and subnet mask.
- Remote Side:** Type in the destination IP address and subnet mask.
- Port Range:** Enter the start and end point number.
- Direction:** The way of the data transmission. In Bound means the data is transferred from outside onto your computer. Out Bound means the data is transferred from your computer onto outside through Internet. **Block** stops the data transmission, **Allow** lets the data pass through.

After configuring the settings, please click **Apply** and the new one you created will be shown on the table.

The rules for IP packet filtering created:

Protocol	Local Side		Remote Side		Port Range		Direction		Modify	Delete
	IP Addr	Netmask	IP Addr	Netmask	Start	End	In	Out		
TCP	0.0.0.0	0.0.0.0	0.0.0.0	0.0.0.0	80	80	Allow	Allow	Modify	Delete
UDP	0.0.0.0	0.0.0.0	0.0.0.0	0.0.0.0	53	53	Allow	Allow	Modify	Delete
TCP	0.0.0.0	0.0.0.0	0.0.0.0	0.0.0.0	21	21	Allow	Allow	Modify	Delete
TCP	0.0.0.0	0.0.0.0	0.0.0.0	0.0.0.0	53	53	Allow	Allow	Modify	Delete
TCP	0.0.0.0	0.0.0.0	0.0.0.0	0.0.0.0	4998	4999	Allow	Allow	Modify	Delete
TCP	203.67.235.1	255.255.255.0	61.222.78.241	255.255.255.0	0	0	Allow	Allow	Modify	Delete

Intrusion Detection

This page displays the rules for intrusion detection. The purpose of intrusion detection is to detect any attacks that penetrate and destroy the firewall & standard detection systems. In addition, it is used to proactively prevent attacks without human intervention before any damage can occur.

[Security]

Firewall

Intrusion Detection

Intrusion Detection

Intrusion Detection is currently enabled.

Configure intrusion detection function to be:

- Disabled
 Enabled

The rules for intrusion detection created:

Use Blacklist	false
Use Victim Protection	false
DOS Attack Block Duration	1800
Scan Attack Block Duration	86400
Victim Protection Block Duration	600
Maximum TCP Open Handshaking Count	100
Maximum Ping Count	15
Maximum ICMP Count	100

DOS Attack Block Duration: It defines the duration that the suspicious host will be blocked once DOS activity is detected. The unit is defined in second.

Scan Attack Block Duration: It defines the duration that the suspicious host will be blocked once Scan activity is detected. The unit is defined in second.

Victim Protection Block Duration: This is to protect victims from spoofing style attacks -- a destination blocking entry is added to black list. It specifies the default duration we are going to keep it in the list to avoid the continuous attack against this victim. The unit is defined in second.

Maximum TCP Open Handshaking Count: The maximum number of unfinished TCP handshaking session will trigger IDS for SYN flood per second.

Maximum Ping Count: The maximum number of PINGs per second will trigger IDS for echo storm.

Maximum ICMP Count: The maximum number of ICMP packets other than ICMP echo (PING) per second will trigger IDS for ICMP flood.

You can select **Disable** and click **Apply** to disabled intrusion detection. Select Enabled to invoke this function. In addition, click **Modify Rules** to enter or modify details for the rules if necessary. After finishing the modification, click **Apply**.

Intrusion Detection - Modify Rules

Please enter details for the rules:

Use Blacklist:

Use Victim Protection:

DOS Attack Block Duration:

Scan Attack Block Duration:

Victim Protection Block Duration:

Maximum TCP Open Handshaking Count:

Maximum Ping Count:

Maximum ICMP Count:

Virtual Server

The Router implements NAT to let your entire local network appear as a single machine to the Internet. The typical situation is that you have local servers for different services and you want to make them publicly accessible. With NAT applied, it will translate the internal IP addresses of these servers to a single IP address that is unique on the Internet. NAT function not only eliminates the need for multiple public IP addresses but also provides a measure of security for your LAN.

When the router receives an incoming IP packet requesting for access to your local server, the router will recognize the service type according to the port number in this packet (e.g., port 80 indicates HTTP service and port 21 indicates FTP service). By specifying the port number, you tell the router which service should be forwarded to the local IP address you specify.

After you setting the virtual server you should modify the filter rule whichever port and service you set on virtual server. Because the firewall has protect the route by filter rule so that you should update the filter rule after you set up virtual server.

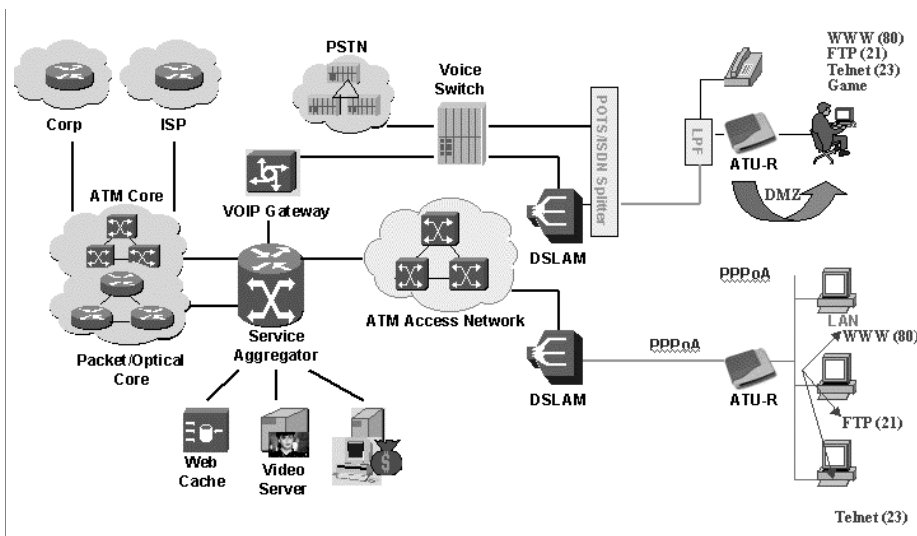

This page shows all virtual server rules configured in your ADSL Router.

[Virtual Server]

Virtual Servers currently created:

PVC Name	External Packet		Internal Host		Modify	Delete
	Protocol	Port	IP Address	Port		

In the virtual server list table, you may select required entry to modify or delete it by clicking **Modify** or **Delete**.

Creating a New Server

In order to add new virtual server service entry, click **Create a new server** button.

[Virtual Server] - Create a New Server

Please enter details for new virtual server:

ATM PVC Name:

External Packet

Protocol:

TCP/IP Port: User Define as (min: 1, max: 65534)

Pre-defined:

Internal Host

IP Address:

TCP/IP Port: (min: 1, max: 65534)

ATM PVC Name: Select the ATM PVC name from the drop down list. Currently only ppp-0 interface is provided.

Protocol: Select a protocol type used by the service that will be forwarded.

TCP/IP Port: The Router supports port mapping function that translates a standard port number to a non-standard number. Incoming data packets sent to a specific IP port can be mapped to the port you specify. The most often used port numbers include: 21 (FTP), 80 (HTTP), 23 (Telnet) and 25(SMTP)

IP Address: Specify the internal IP address to which the packets are forwarded.

Then follow the steps below:

1. Select the ATM PVC interface.
2. Select the protocol type from the drop-down list.
3. Select a service in TCP /IP Port field and enter the port number you want to use.
4. Enter the IP address of the internal server in the IP Address field and enter the TCP/IP port information in the TCP/IP Port field.
5. Click **Apply** to commit the setting.

Setting Up DMZ Host

Direct Mapping Zone (DMZ) uses a technology that makes Router forwarding all incoming packet to internal specific server. To setup DMZ host for your router, please click **Setup DMZ Host** button.

[Virtual Server] - Setup DMZ Host

Please enter details for DMZ host:

ATM PVC Name:

Protocol: Any

IP Address:

Then follow the steps below:

1. Select the ATM PVC interface.
2. Enter the IP address of the internal server in the IP Address field.
3. Click **Apply** to commit the setting.

IGMP Proxy

The Internet Group Management Protocol (IGMP) is an Internet protocol that provides a way for an Internet computer to report its multicast group membership to adjacent routers.

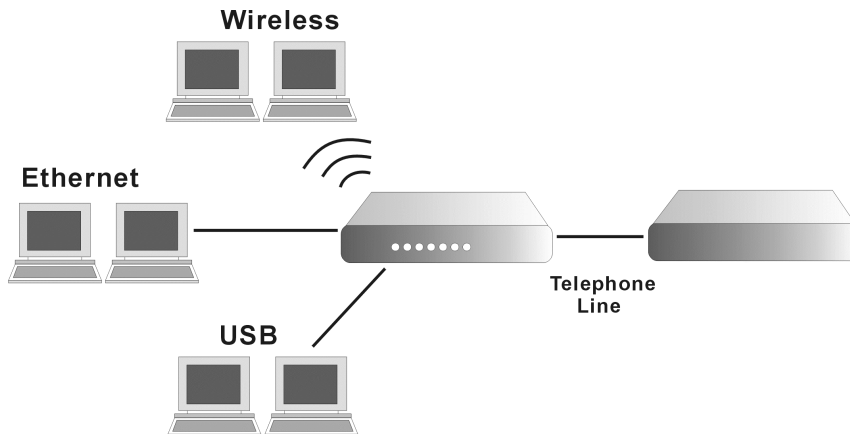

The hosts interact with the system through the exchange of IGMP messages. When you want to configure IGMP proxy, the system will interact with other router through the exchange of IGMP messages. However, when acting as the proxy, the system performs the host portion of the IGMP task as follows:

- When it is queried, the system will send group membership reports to the group.
- When one of the hosts joins a multicast address group to which none of other hosts belong, the system will send unsolicited group membership reports to that group.
- When the last of hosts in a particular multicast group leaves the group, the system will send a leave group membership report to the routers group.

To enable the IGMP Proxy function, please open **Configuration >IGMP**.

[IGMP Proxy]

The IGMP Proxy is currently disabled.

Please select the IGMP Proxy to be:

- Disabled
- Enabled on PVC : ppp-0

Apply

Enabled on PVC: Check this button and choose the interface and click **Apply** to invoke the IGMP settings.

Disable: Close this setting.

[IGMP Proxy]

The IGMP Proxy is currently enabled on ppp-0.

Please select the IGMP Proxy to be:

- Disabled
 Enabled on PVC : ppp-0

Apply

Multicast group membership : **[Refresh]**

Interface	Querier	Group Address
-----------	---------	---------------

UPnP (Optional)

Universal plug and play (UPnP) is an architecture for pervasive peer to peer network connectivity of intelligent appliances and PCs of all form factors. It is designed to bring easy-to-use, flexible, standards-based connectivity to ad-hoc or unmanaged networks whether in the home, in a small business, public spaces, or attached to the Internet.

To enable UPnP function, just check the **Enable UPnP Function** box and then click **Apply** to activate the function.

[UPnP]

UPnP IGD (Internet Gateway Device) function is currently **enabled**.

Enable UPnP IGD Function

Apply

Note:

To activate new setting, you must save configuration and then restart your router.

Only **Windows XP** supports UPnP function. Before checking this function for proper using, you have to install UPnP component to your computer first. Otherwise, the function will not take effect even click on "Enable UPnP IGD Function".

Please follow the steps below for installing UPnP components.

1. Click on the **Start** menu, point to **Settings** and click on **Control Panel**.
2. Select **Add or Remove Programs > Add/Remove Windows Components** to open **Windows Components Wizard** dialog box.

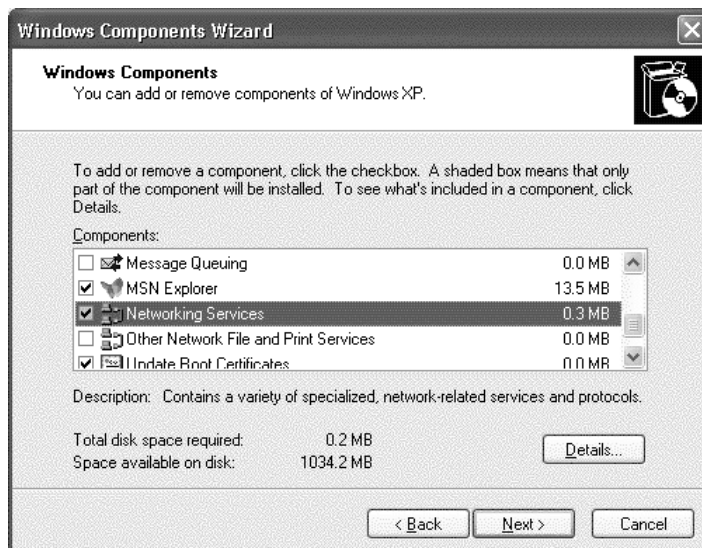

3. Select **Network Services** and click **Details**. Click the **Universal Plug and Play** check box.

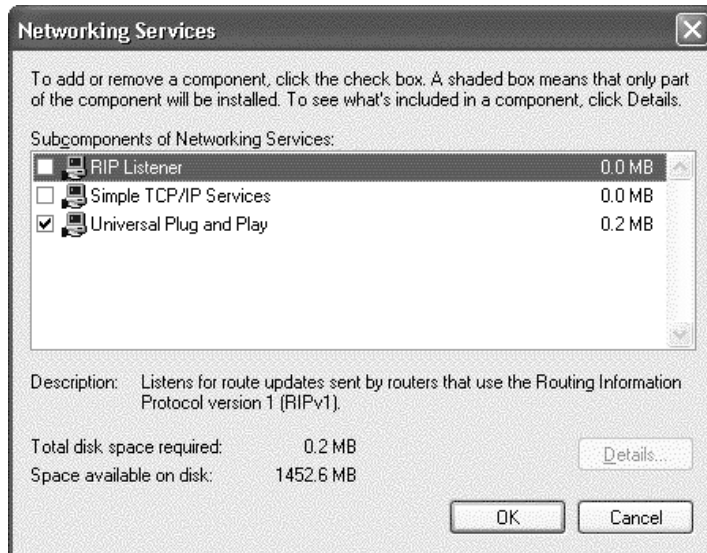

4. Click **Ok**. The system will install UPnP components automatically.
5. After finishing the installation, go to **My Network Places**. You will find an icon (ex: ZXDSL 531B) for UPnP function.

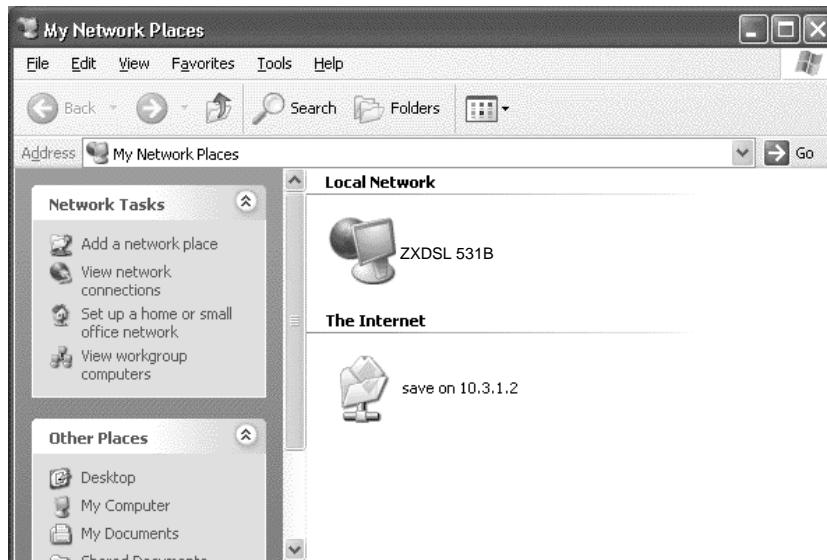

6. Double click on the icon, the ADSL router will open another web page with port (2800) for UPnP function. The IE address will be changed as shown as the following graphic.

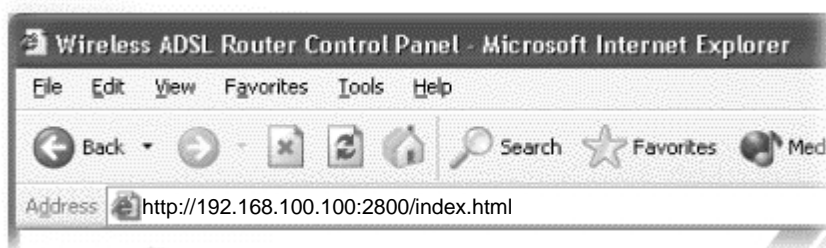

7. Now, the NAT traversal function will be provided. The ADSL router will create a new virtual server automatically for mapping while the router detecting the computer running some Internet applications.

Virtual Servers currently created:

	External Packet		Internal Host			
PVC Name	Protocol	Port	IP Address	Port	Modify	Delete
ppp-0	UDP	14650 (User Define)	192.168.100.2	14650	Modify	Delete
ppp-0	TCP	15530 (User Define)	192.168.100.2	15530	Modify	Delete

Chapter 6: Troubleshooting

If the suggested solutions in this section do not resolve your issue, contact your system administrator or Internet service provider.

Problems with LAN

PCs on the LAN can not get IP addresses from the ADSL Router.

The chances are that the interface used as DHCP server is modified and the client PCs do not renew IP addresses.

If your DHCP server is enabled on Private IP Address previously and you modify the interface to Public IP Address, the client PCs should renew IP addresses.

The PC on the LAN cannot access the Web page of the ADSL Router.

Check that your PC is on the same subnet with the ADSL Router.

The virtual server can't be access after setting virtual server.

Check the filter rule of the port that virtual server service setting for example, the virtual server service set FTP 21 you need update the filter rule of the ftp 21 **Direction** setting: Choose filter the packets that incoming action (In Bound) are **Allow** on the interface.

Problems with WAN

You cannot access the Internet.

- If your ADSL Router is set to routing mode and you use private IP addresses on the LAN, go to **WAN Configuration > ATM PVC > Setup the ATM PVC Interface** page. Make sure that **Enable network address Translation (NAT)** is checked.
- Check the IP settings:
Go to LAN Configuration > IP Address page, ensure you specify IP address on Public IP Address field.
Or go to WAN Configuration > ATM PVC > Setup the ATM PVC Interface page, ensure you specify IP address on Specified Local WAN IP address field
- Check the physical connection between the ADSL Router and the LAN.

If the LAN LED on the front panel is off or keeps blinking, there may be problem on the cable connecting to the ADSL Router.

At the DOS prompt, ping the IP address of the ADSL Router, e.g, ping 192.168.100.100. If the following response occurs:

```
Relay from 192.168.100.100 bytes=32 time=100ms TTL=253
```

Then the connection between the ADSL Router and the network is OK.

If you get a failed ping with the response of:

```
Request time out
```

Then the connection is fail. Check the cable between the ADSL Router and the network.

- Check the DNS setting of the ADSL Router.

At the DOS prompt, ping the IP address of the DNS provided by your ISP. For example, if your DNS IP is 168.95.1.1, then ping 168.95.1.1. If the following response occurs:

```
Relay from 168.95.1.1 bytes=32 time=100ms TTL=253
```

Then the connection to the DNS is OK.

If you get a failed ping with the response of:

```
Request time out
```

Then the DNS is not reachable. Check your DNS setting on the ADSL Router.

Problems with Upgrading

The following lists the error messages that you may see during upgrading and the action to take.

- **Error:** All the ADSL LEDs light up and cannot light off as usual.

Possible cause: When users execute firmware upgrade and save settings to the router, the power for the router is lost for some unknown reasons, the normal web page for the router might be damaged. (see the graphic below) After power on your router, the LEDs might not work normally.

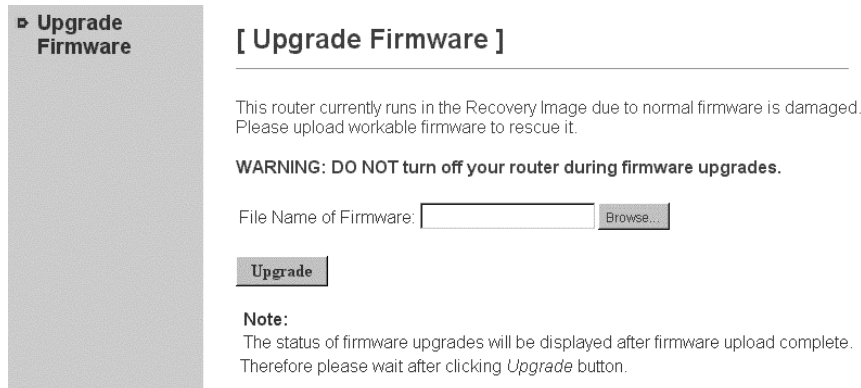

Action: Use the browser to connect to the router for executing image upgrade.

- **Error Message:** invalid checksum

Possible cause: The firmware file to be used is damaged or the file format is wrong.

Action: Make sure that your firmware file format is valid or get a new firmware file.

- **Error Message:** invalid hardcode

Possible cause: The firmware file is not compatible with the model of your ADSL Router.

Action: Download a compatible firmware from the web.

- **Error Message:** unknown flags type

Possible cause: The firmware version is not compatible.

Action: Download a compatible firmware from the web.

- **Error Message:** internal isfs error / internal flashfs error

Possible cause: System error occurs. It may be caused by the lack of memory.

Action: Reboot your ADSL Router and perform the upgrade task again.

- **Error Message:** invalid file format

Possible cause: The firmware file format is invalid.

Action: Check the file format is correct, otherwise download a firmware file with correct format.

- **Error Message:** get an error message

Possible cause: The TFTP server responses with error message.

Action: Make sure the file name you enter is correct. Otherwise the TFTP server may response with the error message "File not found".

- **Error Message:** transfer time out

Possible cause: The transfer session is interrupted.

Action:

- a. Make sure the TFTP server is on the same subnet with the ADSL Router.
- b. Make sure you the IP address of the TFTP server you specify is correct and that your TFTP server is started.
- c. If error still occurs, reboot your ADSL Router and perform the upgrade task again.

- **Error Message:** firmware update in process

Possible cause: The upgrade is already in process.

Action: Do not turn off your ADSL Router otherwise you will cause damage to the device.

- **Error Message:** no remote server IP

Possible cause: The IP address of the TFTP server is not specified.

Action: Specify the IP address of the TFTP server is not specified.

- **Error Message:** can't allocate update buffer

Possible cause: It may be caused by the lack of memory.

Action: Reboot your ADSL Router and perform the upgrade task again.

Chapter 7: Glossary

ARP (Address Resolution Protocol)

ARP is a TCP/IP protocol for mapping an IP address to a physical machine address that is recognized in the local network, such as an Ethernet address.

A host wishing to obtain a physical address broadcasts an ARP request onto the TCP/IP network. The host on the network that has the IP address in the request then replies with its physical hardware address.

Inverse ARP (In-ARP), on the other hand, is used by a host to discover its IP address. In this case, the host broadcasts its physical address and a RARP server replies with the host's IP address.

DHCP (Dynamic Host Configuration Protocol)

When operates as a DHCP server, the ADSL Router assign IP addresses to the client PCs on the LAN. The client PCs "leases" these Private IP addresses for a user-defined amount of time. After the lease time expires, the private IP address is made available for assigning to other network devices.

The DHCP IP address can be a single, fixed public IP address, an ISP assigned public IP address, or a private IP address.

If you enable DHCP server on a private IP address, a public IP address will have to be assigned to the NAT IP address, and NAT has to be enabled so that the DHCP IP address can be translated into a public IP address. By this, the client PCs are able to access the Internet.

LAN (Local Area Network) & WAN (Wide Area Network)

A LAN is a computer network limited to the immediate area, usually the same building or floor of a building. A WAN, on the other hand, is an outside connection to another network or the Internet.

The Ethernet side of the ADSL Router is called the LAN port. It is a twisted-pair Ethernet 10Base-T interface. A hub can be connected to the LAN port. More than one computers, such as server or printer, can be connected through this hub to the ADSL Router and composes a LAN.

The DSL port of the ADSL Router composes the WAN interface, which supports PPP or RFC 1483 connecting to another remote DSL device.

NAT (Network Address Translation) IP Address

NAT is an Internet standard that translates a private IP within one network to a public IP address, either a static or dynamic one. NAT provides a type of firewall by hiding internal IP addresses. It also enables a company to use more internal IP addresses.

If the IP addresses given by your ISP are not enough for each PC on the LAN and the ADSL Router, you need to use NAT. With NAT, you make up a private IP network for the LAN and assign an IP address from that network to each PC. One of some public addresses is configured and mapped to a private workstation address when accesses are made through the gateway to a public network.

For example, the ADSL Router is assigned with the public IP address of 168.111.2.1. With NAT enabled, it creates a Virtual LAN. Each PC on the Virtual LAN is assigned with a private IP address with default value of 192.168.100.2 to 192.168.2.254. These PCs are not accessible by the outside world but they can communicate with the outside world through the public IP 168.111.2.1.

Private IP Address

Private IP addresses are also LAN IP addresses, but are considered "illegal" IP addresses to the Internet. They are private to an enterprise while still permitting full network layer connectivity between all hosts inside an enterprise as well as all public hosts of different enterprises.

The ADSL Router uses private IP addresses by assigning them to the LAN that cannot be directly accessed by the Internet or remote server. To access the Internet, private network should have an agent to translate the private IP address to public IP address.

Public IP Address

Public IP addresses are LAN IP addresses that can be considered "legal" for the Internet, because they can be recognized and accessed by any device on the other side of the DSL connection. In most cases they are allocated by your ISP.

If you are given a range of fixed IP addresses, then one can be assigned to the router and the others to network devices on the LAN, such as computer workstations, ftp servers, and web servers.

PVC (Permanent Virtual Circuit)

A PVC is a logical point-to-point circuit between customer sites. PVCs are low-delay circuits because routing decisions do not need to be made along the way. Permanent means that the circuit is preprogrammed by the carrier as a path through the network. It does not need to be set up or torn down for each session.

RIP (Routing Information Protocol)

RIP is a routing protocol that uses the distance-vector routing algorithms to calculate least-hops routes to a destination. It is used on the Internet and is common in the NetWare environment. It exchanges routing information with other routers. It includes V1, V2 and V1&V2, which controls the sending and receiving of RIP packets over Ethernet.

UDP (User Datagram Protocol)

UDP is a connectionless transport service that dispenses with the reliability services provided by TCP. UDP gives applications a direct interface with IP and the ability to address a particular application process running on a host via a port number without setting up a connection session.

Virtual Server

You can designate virtual servers, e.g., a FTP, web, telnet or mail server, on your local network and make them accessible to the outside world. A virtual server means that it is not a dedicated server -- that is, the entire computer is not dedicated to running on the public network but in the private network.

VPI (Virtual Path Identifier) & VCI (Virtual Channel Identifier)

A VPI is a 8-bit field while VCI is a 16-bit field in the ATM cell header. A VPI identifies a link formed by a virtual path and a VCI identifies a channel within a virtual path. In this way, the cells belonging to the same connection can be distinguished. A unique and separate VPI/VCI identifier is assigned in advance to indicate which type of cell is following, unassigned cells, physical layer OAM cells, metasignalling channel or a generic broadcast signaling channel. Your ISP should supply you with the values.

Appendix: Specifications

Software

ADSL Compliance

For Annex A ADSL Router

- ANSI T1.413 Issue 2
- ITU G.992.1 Annex A (G.dmt)
- ITU G.992.2 Annex A (G.lite)
- ITU G.994.1 (G.hs)

For Annex B ADSL Router

- ITU G.992.1 Annex B (G.dmt)
- ITU G.994.1 (G.hs)

ATM Features

- Compliant to ATM Forum UNI 3.1 / 4.0 Permanent Virtual Circuits (PVCs)
- Support up to 8 AAL5 Virtual Circuit Channels (VCCs) for UBR, CBR, VBR-rt, and VBR-nrt with traffic shaping
- TR-037 Auto PVC (auto-provisioning)
- RFC1483 (RFC2684) LLC Encapsulation and VC Multiplexing over AAL5
- RFC2364 Point-to-Point Protocol (PPP) over AAL5
- RFC2225 Classical IP and ARP over ATM
- RFC2516 PPP over Ethernet: support Relay (Transparent Forwarding) and Client functions
- OAM F4/F5 End-to-End/Segment Loopback Cells

Bridging Features

- Supports self-learning bridge specified in IEEE 802.1D Transparent Bridging
- Supports up to 4000 learning MAC addresses
- Transparent bridging among 10/100 Mb Ethernet and 802.11b LAN interfaces

Routing Features

- UPnP IGD (Internet Gateway Device) with NAT traversal capability support
- NAT (Network Address Translation) / PAT (Port Address Translation) let multiple users on the LAN to access the internet for the cost of only one IP address and enjoy various multimedia applications.
- ALGs (Application Level Gateways): such as NetMeeting, FTP, Quick Time, mIRC, Real Player, CuSeeMe, etc.
- Multiple Virtual Servers (e.g., Web, FTP, Mail servers) can be setup on user's local network.
- Static routes, RFC1058 RIPv1, RFC1723 RIPv2.
- DNS Relay
- ARP Proxy

Security Features

- PAP (RFC1334), CHAP (RFC1994) for PPP session
- Firewall support IP packets filtering based on IP address/Port number/Protocol type and TCP code field flags

- Intrusion Detection provides protection from a number of attacks (such as SYN/FIN/RST Flood, Smurf, WinNuke, Echo Scan, Xmas Tree Scan, etc)
- WEP (Wired Equivalent Privacy) encryption uses RC4 with 64/128 bit key length (for wireless ADSL router only)

Wireless LAN Features

- Fully compatible to IEEE 802.11b standard and allow operating range up to 300 meters (open space) and 100 meters (indoor).
- The Direct Sequence Spread Spectrum (DSSS) technology is exploited.
- Seamless roaming within the 802.11 and 802.11b wireless LAN infrastructure
- Low power consumption via efficient power management

Configuration and Management

- User-friendly embedded web configuration interface with password protection
- Remote management accesses control
- Telnet session for local or remote management
- HTTP firmware upgrades via web browser GUI directly
- Distribute IP addresses to end users via DHCP server provided by ADSL router
- SNMPv1/v2c agent with MIB-II, PPP MIB, ADSL Line MIB

Hardware

Interface

- One RJ-11 port for ADSL connection
- Four RJ-45 port for IEEE 802.3 10/100 Base-T auto-sensing Ethernet connection
- One hidden reset button for restoring to factory default settings

Regulatory Approvals and Compliance

- EMI/Immunity: FCC part 15 and part 68 Class B
- Safety: UL, CE

Power Requirement and Operation Environment Requirement

- Power Adaptor: Input 110±10 or 230±10 VAC; Output 12 VDC, 1A
- Power Consumption: less than 10 Walt
- Ambient Temperature: 0 to 45°C (32 to 113°F)
- Relative Humidity: 20% to 90% (non-condensing)

Physical

- Dimensions: 159mm(L) × 122mm(W) × 41.5mm(H)
- Weight: 282g